

USER MANUAL

DBM 620

**AIR FLOW METER
& SMARTKAP APPLICATION FOR DBM 620**

Table of contents

1. SAFETY INSTRUCTIONS.....	5
1.1 SmartKap application.....	5
1.1.1 Exclusions and restrictions of liability.....	5
1.1.2 Exclusions and warranty limitations.....	5
1.2 DBM 620 air flow meter.....	5
1.2.1 Warning.....	5
1.2.2 Environment protection.....	6
1.3 Symbols used.....	6
2. AIR FLOW METER PRESENTATION.....	7
2.1 Key points.....	7
2.2 Technical features.....	8
2.3 General features.....	9
2.4 Maintenance.....	9
2.5 Warranty.....	9
2.6 Standard.....	10
2.6.1 FCC rules.....	10
2.6.2 Canadian standard.....	10
3. AIR FLOW METER DESCRIPTION.....	11
3.1 Base.....	11
3.2 Grid.....	11
3.3 Electronic module.....	12
3.3.1 Features.....	12
3.3.2 Power supply and batteries replacement.....	13
3.3.3 Use the Pitot tubes fixing accessory.....	13
3.4 Hoods.....	13
3.4.1 Description.....	13
3.4.2 Mounting of the hoods.....	14
3.4.3 First mounting.....	14
3.4.4 Elements storage.....	16
3.4.5 Second mounting.....	16
4. TROUBLESHOOTING.....	17
5. SMARTKAP MOBILE APP.....	18
5.1 Presentation.....	18
5.2 Minimal required configuration.....	18
5.3 Mobile application installation.....	18
6. USE SMARTKAP APPLICATION.....	19
6.1 Set the DBM 620 module.....	19
6.1.1 Activate/deactivate the automatic connection.....	19
6.1.2 Set the auto-shut-off.....	19
6.1.3 Set the autozero.....	19
6.1.4 Access the DBM 620 module information.....	19
6.2 Start, hold or stop the measurement.....	20
6.3 Use the application in balometer mode.....	21
6.3.1 Connect the mobile device and the DBM 620 module.....	21
6.3.2 Set the measurements.....	22
6.3.2.1 Select the air vent type.....	22
6.3.2.2 Select a standardised airflow.....	24
6.3.3 Modify the air vent factors.....	24
6.3.4 Save a measurement dataset.....	26
6.4 Use the application in manometer mode.....	27
6.4.1 Connect the mobile device and the module.....	27
6.4.2 Set the measurements.....	28
6.4.2.1 Select the differential pressure device.....	28
6.4.2.2 Select the air duct type and define its features.....	29
6.4.3 Set the compensation temperature and the static pressure.....	29
6.4.3.1 Set the compensation temperature.....	29
6.4.3.2 Activate and set the static pressure.....	29
6.4.4 Record a measurement dataset.....	30
6.4.4.1 Save an automatic dataset.....	30
6.4.4.2 Save a point by point dataset.....	31
6.4.4.3 Save an automatic point by point dataset.....	32
6.5 Set the correction coefficient.....	33
6.6 Modify the measurement units.....	33
6.7 Fill in operator information.....	34
6.8 Manage measurements records and datasets.....	34
6.8.1 Access the measurement records and datasets.....	34
6.8.2 Export the values.....	35
6.8.3 "Air Change Rate" function (ACR).....	36
6.8.4 Example of pdf report.....	36



Before using the device, please read carefully this user manual. It delivers important information about the device operating, maintenance and reprocessing.

1.1 SmartKap application

1.1.1 Exclusions and restrictions of liability

The application operation is under the exclusive customer or user entity responsibility, who acknowledges using this system at his/her own risks. The customer or user entity explicitly excludes Sauermann and every other company through which the it could have been sold of any kind of responsibility or warranty regarding any direct, indirect, accidental, consecutive or non-consecutive damage that could have been subjected, for some or all, by partial or total non-respect, voluntary or involuntary, of recommendations, conditions and prerequisites indicated hereafter.

1.1.2 Exclusions and warranty limitations

Sauermann guarantees that the application, which is made available for the customer or user entity through digital content such as a DVD or a downloaded link as indicated in our commercial documents, are in a state enabling its correct installation and operation. Within the limits of the law, this warranty is exclusive. Therefore, we do not guarantee the application operation after its availability to the customer or user entity of this digital support or downloaded link. There is no other explicit or implicit guarantee regarding the application merchantability and fitness for a particular purpose. The customer or user entity acknowledges accepting all the present guarantee limitations or exclusions.

1.2 DBM 620 air flow meter

- Interior or exterior use.
- This device has been developed for the pressure, air flow, temperature and hygrometry measurement in airvent outlet. It must not be used in any other purpose.
- This device has been developed, produced and sold exclusively to trained and qualified experts in the field of HVACR. Appropriate training is necessary in order to guarantee a riskless use of this instrument. Sauermann is not responsible for any possible accident during its use.
- Please always use the device in accordance with its intended use and within parameters described in the technical features in order not to compromise the protection ensured by the device.
- When installing the device, the safety of the system integrating the device is the responsibility of the system assembler.
- This device can pose a risk for wearers of pacemakers. Respect a distance of at least 10 cm between the device and the wearer.
- Only the accessories provided with the device or available as an option must be used.
- Do not use the device if it is damaged or if it operates abnormally. Inspect the device before every use. In case of doubt, please contact the Sauermann's After-sales service.

1.2.1 Warning

- Do not authorise pressures beyond the device limits. Please refer to the technical features described in this user manual.
- The device must not be exposed to rain or any other humid environments (> 80 %RH).
- Do not use the device next to explosive gases, vapour or dust.
- Do not place your fingers in movable zones of the device (articulations).
- The device must not be used in ATEX zones according to applicable standards.
- Do not store the device with solvents. Do not use desiccants.
- The device does not contain any internal part repairable by the user. Do not open the device. The maintenance must be performed by Sauermann only.

- If the device falls or in case of similar inconveniences, or if an irregular malfunction appears, please send back the device to Sauermann After-sales service for a technical check and to ensure your own safety.

1.2.2 Environment protection

Send back the device at its end of working life in a waste collection centre for electrical and electronic components (according to local regulations), or send it back to Sauermann to ensure a required waste collection in the respect of the environment.



1.3 Symbols used

For your safety and in order to avoid any damage of the device, please follow the procedure described in this user manual and read carefully the notes preceded by the following symbol:



The following symbol will also be used in this user manual:

Please read carefully the information notes indicated after this symbol.



2. AIR FLOW METER PRESENTATION

The DBM 620 air flow meter allows **control and balancing** of airflow in air conditioning system. Thanks to the **interchangeable hoods**, the air flow meter can be used on any type of grids or diffusers in air supply or exhaust. Easy to handle, lightweight, it allows **accurate, sturdy and fast measurements**. It is supplied in standard with a **610 x 610 mm hood** with **flow straightener** and **foldable frame**.

Four other dimensions are available as options:

- 1020 x 1020 mm
- 720 x 720 mm
- 720 x 1320 mm
- 420 x 1520 mm



These hoods are airtight and have a transparent viewing window, allowing the user to see through the vent to ensure that the hood is in proper position. The rods, made of fibreglass, provide a sturdiness of hoods.

The measurement grid, attached to the base, allows the measurement through **24 points** all over the surface of the grid. Measurement is performed using a **differential pressure sensor**, adjusted in atmospheric pressure and temperature, compensated in temperature.

The Patented* **DBM 620** folding frame limits space restrictions and allows for easier mounting.



The measuring unit of the air flow meter, removable, can be used as a micromanometer. Real addition to airflow measurement, this instrument allows, by connecting a Pitot tube, to measure airflow velocity in air duct or, by connecting two silicone tubes, to check filter fouling of air station.

It is also possible to connect the matrix grid designed for air velocity measurements on any types of large ceiling vent or diffuser. This grid calculates the average air velocity from 24 points to guarantee a reliable measurement. Please respect a minimum distance of 15 cm between the measuring unit and the measurement grid.

2.1 Key points

- Measuring range from 35 to 4250 m³/h
- Interchange hoods quickly and easily
- 610 x 610 mm hood with airflow straightener to be compatible with every air vent types
- SmartKap mobile application for data reading and exploitation
- Foldable frame and space-saving hoods
- Transport case: compact storage system



*Foldable frame patent granted in France (patent number: 1859064)

2.2 Technical features

Parameter	Accuracy ⁽¹⁾	Measuring range	Resolution
Airflow (calculated parameter)	±3% of the measurement ±10 m ³ /h	From 35 to +4250 m ³ /h	1 m ³ /h
Air velocity (calculated parameter)	±3% of the measured value ±0.04 m/s	From 0.2 to 10 m/s	0.01 m/s up to 3 m/s and 0.1 m/s beyond
Temperature (NTC)	±0.2°C	From -20 to 70°C	0.1 °C
Relative humidity (capacitive sensor)	Repeatability, linearity: ±1.5% RH ⁽²⁾ (from 10 to 80% RH and from 10 to 50°C) ⁽³⁾ Hysteresis: 0.8% RH at 25°C Time drift: <0.5% RH per year in normal conditions of use (from 5 to 50°C and from 20 to 80% RH, apart from indoor pollutants)	From 0 to 100% RH	0.1% RH
Atmospheric pressure	±3 hPa	From 700 to 1100 hPa	1 hPa
Pressure⁽⁴⁾	±0.2% of reading ±2 Pa ⁽⁵⁾	From -2500 to +2500 Pa	From 0.001 to 0.1 Pa

⁽¹⁾All accuracies indicated in this document were stated in laboratory conditions and can be guaranteed for measurement carried out in the same conditions or with calibration compensation.

⁽²⁾Accuracy in RH depends on temperature: typical ±2% RH below 10°C and above 50°C.

⁽³⁾The sensor shows best performance when operated within recommended normal temperature and humidity range of 5°C–60°C and 20%RH–80%RH, respectively. Long-term exposure to conditions outside normal range, especially at high humidity, may temporarily offset the RH signal (e.g. +3%RH after 60h kept at >80%RH). After returning into the normal temperature and humidity range the sensor will slowly come back to calibration state by itself. Prolonged exposure to extreme conditions may accelerate ageing.

⁽⁴⁾Tolerated overpressure: 344.73 mbar. Proof pressure: 500 mbar. Burst pressure: 750 mbar.

⁽⁵⁾Potential drift: ±0.04% of reading per degree.

2.3 General features

Display	On smartphone or tablet ⁽¹⁾
Integrated support for smartphone or tablet	Adjustable integrated support Smartphone or tablet max. dimensions: 6.2"
Connectors/Pneumatic	ABS connectors, Ø7 x 4 mm
Maximum service pressure	500 mbar
Storage capacity	Standard size of a measurement dataset report: 1 Mo
Module	Shock-proof made of ABS
Protection	IP40
Keypad	1 key on the module
Power supply	4 alkaline batteries LR6 AA 1.5V ⁽²⁾
Battery life	Up to 30 hours
Wireless connection	Class 1 BLE 4.2 Wireless connection range: 2.4 GHz Range up to 30 m (98 ft) - Depending on smartphone and tablet wireless connection radio strength. Minimum required versions: Android 7.1, iOS 12.4, BLE 4.0
Device dimensions	Folded: 475 x 455 x 255 mm Mounted: 610 x 610 x 980 mm
Environmental conditions of use	Air, non corrosive and combustible gases Temperature: from -5 to +50°C, in dry air and non-condensing condition Hygrometry: in non-condensing conditions (< 80% RH) Maximum altitude: 2000 m
Storage temperature	From -20 to +60°C
Auto-shut-off	Adjustable from 0 to 60 minutes
Weight (with batteries)	2900 g
Languages	German, Spanish, Italian, Dutch, Portuguese, Hungarian, Polish, Romanian, Russian, Slovak, Finnish, Danish, Norwegian, Swedish, Chinese, Korean, Japanese
European Union directives	2011/65/EU RoHS II; 2012/19/EU WEEE; 2014/53/EU RED

⁽¹⁾ Device not provided.

⁽²⁾ We recommend the use of type Nx PCA9002 batteries.

2.4 Maintenance

Clean the device with a dry and clean cloth. Do not use solvents.

2.5 Warranty

The device has 1-year guarantee against any manufacturing defect (return to our After-sales service required).

2.6 Standard

2.6.1 FCC rules

This device complies with Part 15 of the FCC Rules. Operation is subject to the following two conditions: (1) this device may not cause harmful interference, and (2) this device must accept any interference received, including interference that may cause undesired operation.

Contains FCC ID: QOQBGM111

This equipment has been tested and found to comply with the limits for a Class B digital device, pursuant to part 15 of the FCC Rules. These limits are designed to provide reasonable protection against harmful interference in a residential installation. This equipment generates uses and can radiate radio frequency energy and, if not installed and used in accordance with the instructions, may cause harmful interference to radio communications. However, there is no guarantee that interference will not occur in a particular installation. If this equipment does cause harmful interference to radio or television reception, which can be determined by turning the equipment off and on, the user is encouraged to try to correct the interference's by one or more of the following measures:

- Reorient or relocate the receiving antenna.
- Increase the separation between the equipment and the receiver.
- Connect the equipment into an outlet on a circuit different from that to which the receiver is connected.
- Consult the dealer or an experienced radio/TV technician for help.

Any changes or modifications to this equipment not expressly approved by Sauer mann may cause, harmful interference and void the FCC authorization to operate this equipment.

2.6.2 Canadian standard

This device contains licence-exempt transmitter(s)/receiver(s) that comply with Innovation, Science and Economic Development Canada's licence-exempt RSS(s). Operation is subject to the following two conditions:

1. This device may not cause interference.
2. This device must accept any interference, including interference that may cause undesired operation of the device.

3. AIR FLOW METER DESCRIPTION

3.1 Base

- Outside of the base:



1. DBM 620 electronic module
2. Electronic module connecting plugs
3. Thermo-hygrometric measurement platen
4. and 5. Press to connect or disconnect the module of the base

- Inside the base:

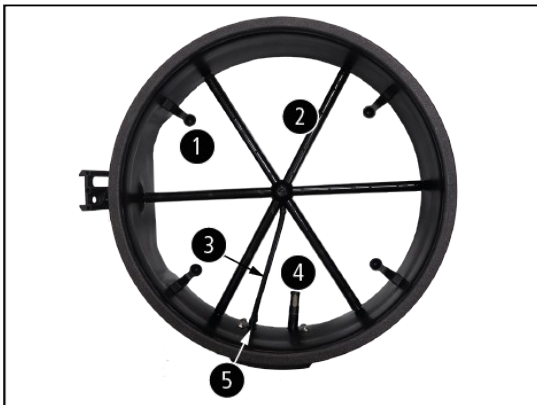

1. Receipt cup hood rods
2. Measurement grid
3. Silicone tube for pressure routing
4. Temperature and hygrometry probe
5. Two pressure connectors

3.2 Grid

The measurement grid is fixed to the base in 6 points and is made up of the following elements:

- 2 chambers (for total pressure and for static pressure)
- 2 pressure connectors

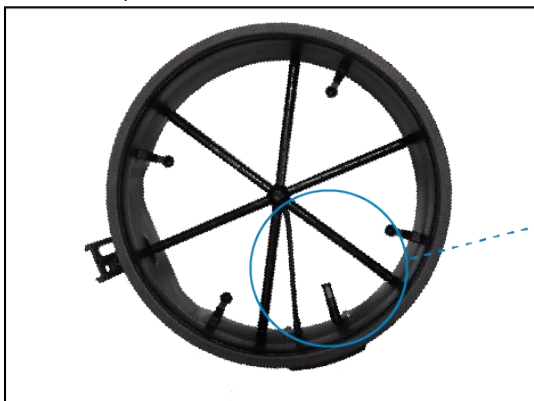

The measurement grid allows to perform differential pressure measurements: attached to the base, it allows the measurement through **24 points** all over the surface of the grid. Measurement is performed using a **differential pressure sensor**, adjusted in atmospheric pressure and temperature, compensated in temperature.

3.3 Electronic module

3.3.1 Features

- Shock-proof made of ABS
- IP40 protection
- Adjustable auto-shut-off with the mobile application from 0 to 60 minutes
- Automatic autozero
- Removable module for micromanometer function

The electronic module takes into account the atmospheric pressure, temperature and hygrometry compensation and automatically operates in air supply or exhaust.

Front view of the module



Back view of the module



Module presentation on the base



Module attached to the base



1. 2 plastic plugs to fix the module on the base (air flow meter mode)
2. On/Off, "Start recording", "Stop recording" and "Hold" button
3. 2 pressure plugs allow to set the module on the base and the connection of silicone tubes
4. Location for the Ø3 mm, Ø6 mm or Ø8 mm Pitot tube fixation (see page 13 how to use the Pitot tube fixing accessory)
5. Battery trap

3.3.2 Power supply and batteries replacement

The airflow meter is supplied in standard with 4 batteries type AA LR6 1.5V.

To replace batteries:

- Remove the batteries cover then used batteries.
- Replace batteries respecting carefully the polarity.
- Replace the batteries cover.
- Reconnect the module.

3.3.3 Use the Pitot tubes fixing accessory

To carry out a measurement with a Pitot tube, it is necessary to use the Pitot tubes fixing accessory. The usable Pitot tubes are the following: Ø3 mm, Ø6 mm or Ø8 mm.



Please follow these steps:

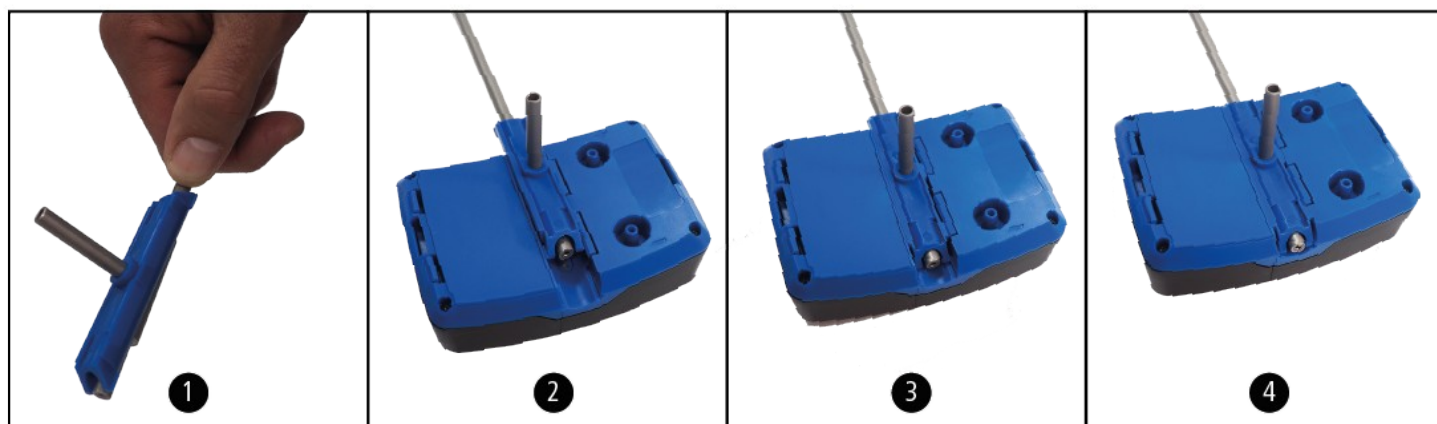

1. Put the Ø3 mm, Ø6 mm or Ø8 mm Pitot tube on the fixing accessory.
2. Present this assembly on the back of the DBM 620 module in front of the slots.
3. Press the assembly to clip the accessory on the module.
4. Slide the assembly toward the bottom of the module to finalise the fixation on the module.

To remove the Pitot tube and its accessory, please proceed on reverse order.

3.4 Hoods

3.4.1 Description



1. Transparent mica allowing a good visibility and making easy the position of the hood
2. Cloth of the hood
3. Elastic to position and hold the hood on the base. Self-adhering trip to fix the hood on the base.
4. Frame with an elastomer joint to ensure a good airtight with ceiling
5. Hoods frame rods

3.4.2 Mounting of the hoods

3.4.3 First mounting

Once the device received, please follow these steps to mount the elements on the base:

1. Unfold the frame

The foldable frame allows a quicker and easier mounting and a compact storage system.

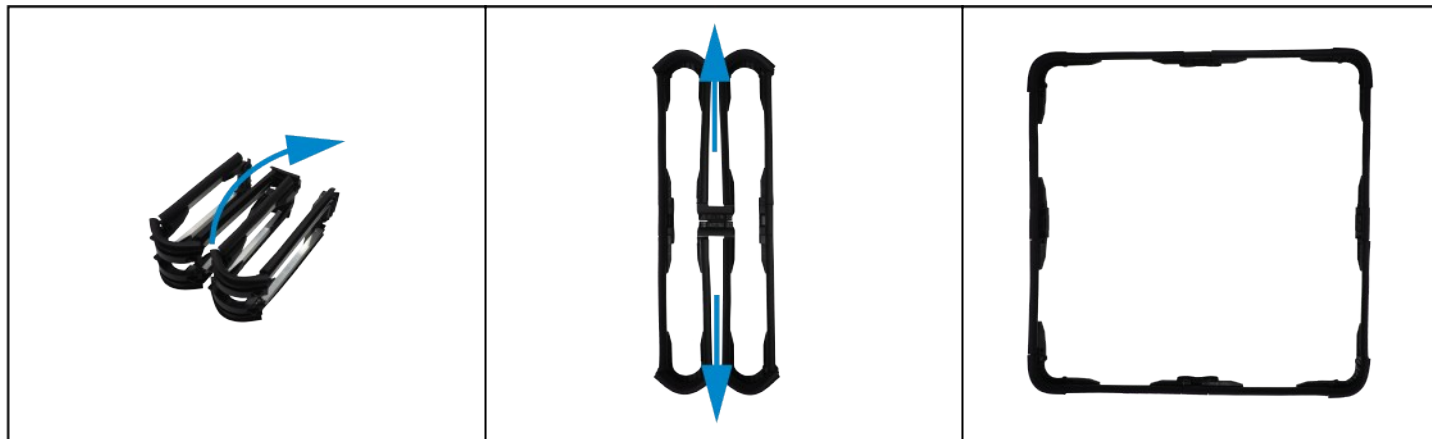

2. Mount the frame with the hood

- The frame elastomer joint must be placed toward the outside.
- Insert the 4 hood strips in the dedicated slots on the 4 sides of the frame.
- Tighten the strips.



Do not tight fully the strips: in order not to damage the hood cloth, it is recommended to adjust the strips tightening at the end of the mounting.

- Adjust the hood corner on the frame.



3. Mount the hood on the base and position the rods

- The transparent part must be oriented towards the user. The coloured strip inside the hood is a visual mark: it must be placed on the opposite side of the user. This coloured marked strip has to be positioned in front of the arrow mark of the base. Position the frame's corners with retaining stops towards the window side of the hood.
- To position the hood on the base, check that the self-adhering trip to fix the hood on the base is not fixed.
- Tighten and fix the self-adhering trip to fix the hood on the base.
- Put the rods inside the hood.
- Place the rods on the dedicated receipt cups then adjust them on the opposite corner of the hood.



Position the rods to cross on the transparent side of the hood and on the opposite site of the transparent part.

- Adjust the strips tightening.



4. Mount the measurement grid for a micromanometer mode use

- Mount the positioning struts on the grid.
- Clip the DBM 620 module on the last notch of the pole. Please respect a minimum distance of 15 cm between the measuring unit and the measurement grid.
- Plug the pressure tubes: the black tube on (-), the transparent tube on (+).
- Connect the pressure tubes to the module: the black tube on (-), the transparent tube on (+).



5. Set the smartphone support

The support for Smartphone can be set in portrait or landscape mode:

- Use an Allen* key of 3 mm to unscrew the support sides.
- Adjust the required space with the roller then screw back the support.



*not supplied with the DBM 620.

3.4.4 Elements storage

A complete disassembly is not necessary to store the elements in the transport case. Only fold the frame, hood and base assembly:

- Remove the rods.
- Fold the first sides of the frame by pressing the clips located on the top of the frame (1).
- Fold the other sides of the frame by pressing the clips located on the outside of the frame, below the cloth (2).
- Without disassembly them, fold the hood cloth and the frame inside the base.

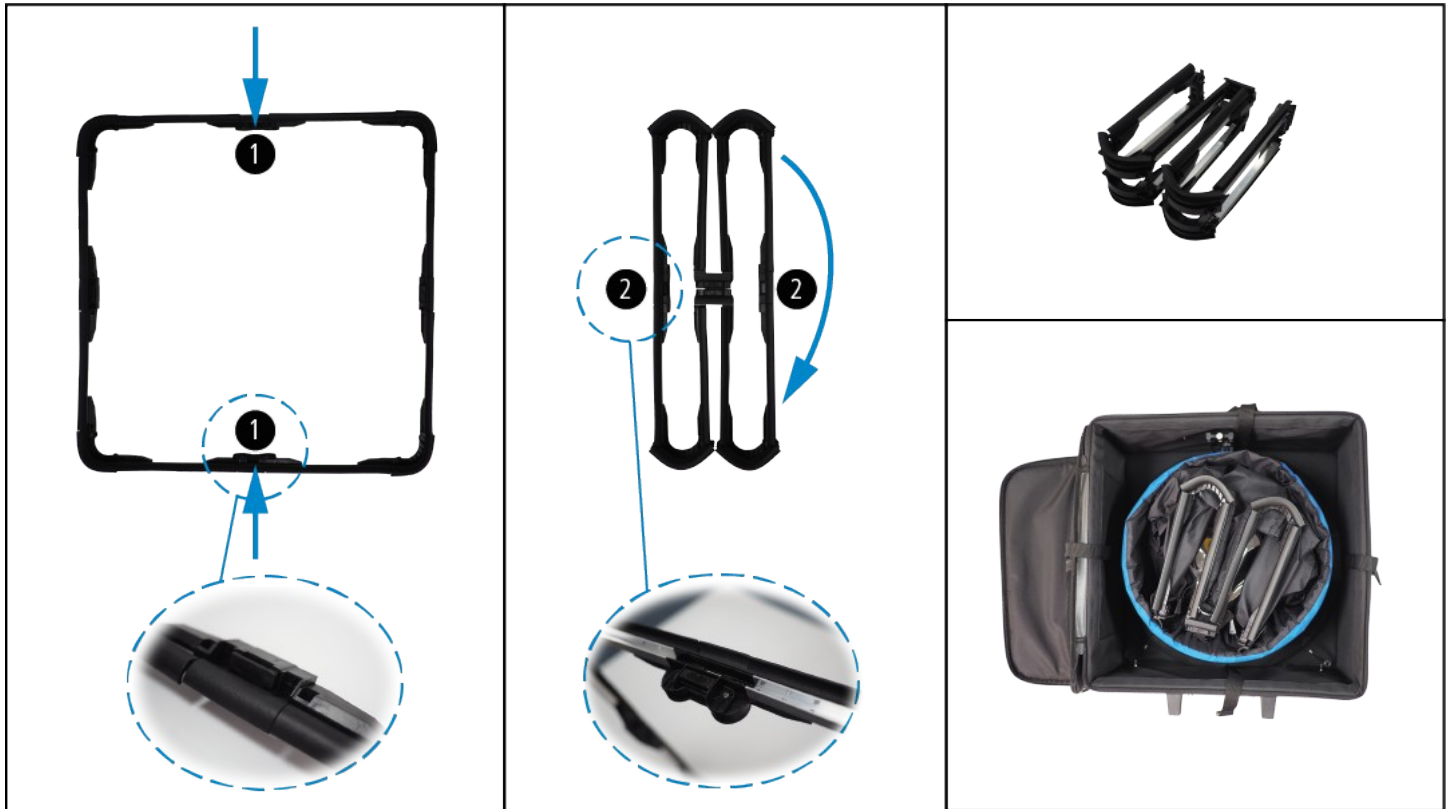

3.4.5 Second mounting

Once the first mounting has been carried out, only the frame needs to be unfolded and the rods positioned.

4. TROUBLESHOOTING

Problem	Probable cause and possible solution
The DBM 620 does not switch on.	Batteries can be defective or flat. Replace the old batteries by new ones, respecting carefully the polarity. For batteries replacement, please see page 13.
The DBM 620 module is broken.	Do not use the device if it is broken or if it works abnormally. Inspect the device before each use. In case of doubt, please contact Sauermann's after-sales service.
Batteries inside the DBM 620 are leaking.	Carry protective gloves and remove the batteries. Carry out a cleaning with a clean and dry cloth. Replace the old batteries by new ones, respecting carefully the polarity. For batteries replacement, please see page 13.

5. SMARTKAP MOBILE APP

5.1 Presentation

SmartKap application allows the DBM 620 air flow meter measurements visualisation and exploitation. The application communicates with wireless connection via the smartphone/tablet and the DBM 620 module.

5.2 Minimal required configuration

For an optimal operation, the following minimum required versions must be installed on the tablet or smartphone:

- Android 4.4
- iOS 8

5.3 Mobile application installation



- Flash the QR code to download SmartKap application on your smartphone or tablet.
or
- Write **"SmartKap"** in the search bar then validate..
- Download the application by pressing the following icon. 
- Follow your mobile device indications.



6. USE SMARTKAP APPLICATION

6.1 Set the DBM 620 module

The application allows to set 3 parameters for the DBM 620 module:

- automatic connection activation or deactivation
- auto-shut-off
- autozero interval

It also allows to get information on the DBM 620 module.

To carry out these settings and get information, the DBM 620 module must be connected via wireless connection to the smartphone or the tablet. See page 21 or page 27.

6.1.1 Activate/deactivate the automatic connection

The automatic connection allows to connect automatically the DBM 620 module to the smartphone or to the tablet when the SmartKap application is started.

From the measurement screen:

- Press **"Options"**.
The list of options to set displays.
- Activate the automatic connection in **"Device"** part.

6.1.2 Set the auto-shut-off

The auto-shut-off allows to set a time before the DBM 620 module switches off.

From the measurement screen, when no communication is in progress:

- Press **"Options"**
The list of options to set displays.
- Press **"Auto-shut-off"** in **"Device"** part.
- Select the auto-shut-off duration between **1 and 60 minutes** or select **"None"**.
- Press **"Select"** at the bottom of the screen.

6.1.3 Set the autozero

The autozero allows to set an interval between two autozeros.

From the measurement screen:

- Press **"Options"**.
The list of options to set displays.
- Press **"Autozero"** in **"Device"** part.
- Select the autozero interval between **1 and 60 seconds** or select **"None"**.
- Press **"Select"** at the bottom of the screen.

6.1.4 Access the DBM 620 module information

The application allows to obtain information on DBM 620 module.



The DBM 620 module must be connected via wireless connection on the smartphone or tablet.

From the measurement screen:

- Press **"i"** icon.
The following screen displays:

This screen displays the following information:

- Serial number
- Firmware version
- Last calibration date

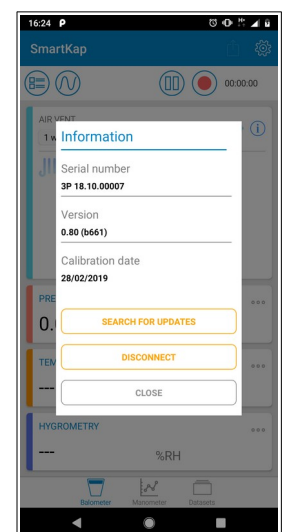

6.2 Start, hold or stop the measurement

To start, hold or stop the measurement, use the mobile application buttons: **"Rec"**, **"Stop"** or **"Pause"**. It is also possible to use the button on the DBM 620 module.

Dataset type (micromanometer mode)	Via the mobile application	With the DBM 620 module button
Automatic	Press "Rec" then "Validate" to start recording. Press "Stop" to stop the measurement dataset.	Press "Rec" from the mobile application, then the DBM 620 module button to start recording. Press again the DBM 620 button to stop the measurement dataset.
Point by point	Press "Rec" then "Validate" to start recording. Press "Stop" to stop the measurement dataset.	- Once the recording started: each time the DBM 620 button is pressed, a point is recorded. -
Point by point automatic	Press "Rec" then "Validate" to start recording. Press "Stop" to stop the measurement dataset.	- Once the recording started: each time the DBM 620 button is pressed, points are recorded during the defined period. -
Micromanometer and balometer modes	Via the mobile application	With the DBM 620 module button
-	Press "Pause" to hold measurement (Hold function). This function is available only in "Measurement" mode, that is beyond recording mode.	Press the DBM 620 button to hold measurement (Hold function). This function is only available in "Measurement" mode, that is beyond recording mode.
Automatic	Press "Rec" then "Validate" to start recording. Press "Stop" to stop the measurement dataset.	Press "Rec" from the mobile application, then the DBM 620 module button to start recording. Press again the DBM 620 button to stop the measurement dataset.

6.3 Use the application in balometer mode

6.3.1 Connect the mobile device and the DBM 620 module

Here is the procedure to follow to connect the smartphone or the tablet in wireless connection to the DBM 620 module:

 Wireless connection must be activated on the smartphone or the tablet.

➤ Switch on the DBM 620 module by pressing the module button.
It flashes quickly in blue.

➤ Launch SmartKap application by pressing the following icon 
*The application opens automatically in "Balometer" mode.
The following screen displays:*

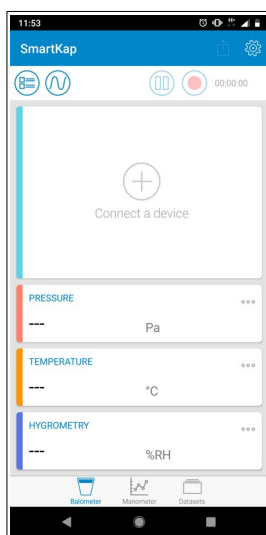

➤ Press "**Connect a device**".
The following screen displays:

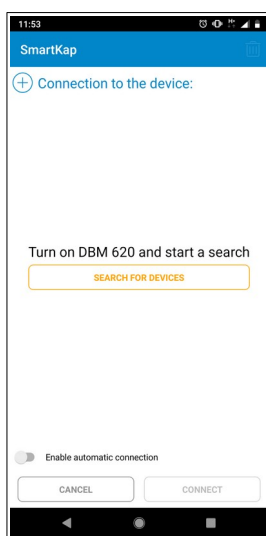

➤ Press "**Search devices**".

*The smartphone/tablet searches available devices. The devices found are displayed as following:
"DBM 620 XX XX.XX.XXXXXX"*

➤ Press the line of the required device.
A check mark appears on this line.

➤ Click "**Connect**" in the lower-right corner of the screen.

The following screen displays:

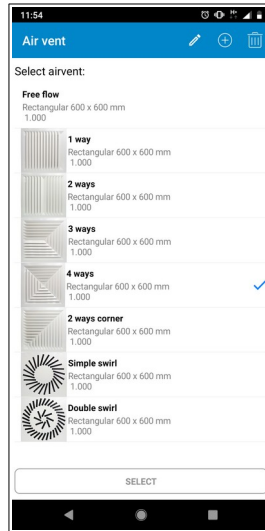

- Press the air vent type on which measurements will be carried out.
- Press **“Select”** at the bottom of the screen.
- Position the air flow meter thanks to the animation explaining how to position correctly the air flow meter on the air vent.
- Press **“Close”**.

The measurement screen displays:

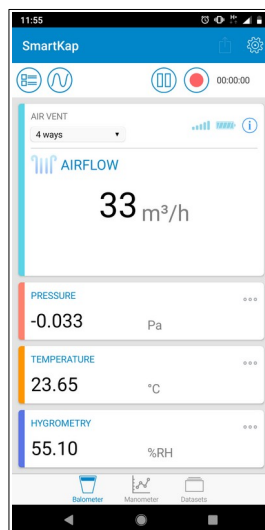

6.3.2 Set the measurements



The parameters to set are the air vent type, the correction coefficient and standardised airflow.

6.3.2.1 Select the air vent type

The application contains 7 different preset air vent types and offers the possibility to add as many air vents as required.

To select a preset air vent:

From the measurement screen:

- Press **“Options”**.
The list of options to set displays.
- Press **“Air vent”** in **“Measures”** part.

The available air vent types list displays:

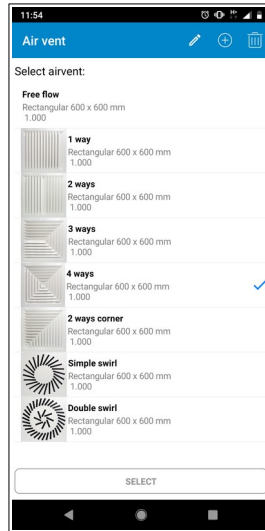

- Press the required air vent type.
- Press **"Select"** at the bottom of the screen.

To select a customized air vent type, it first needs to be created.
From the parameters screen:

- Press **"Air vent"** in **"Measures"** part.
The following screen displays:

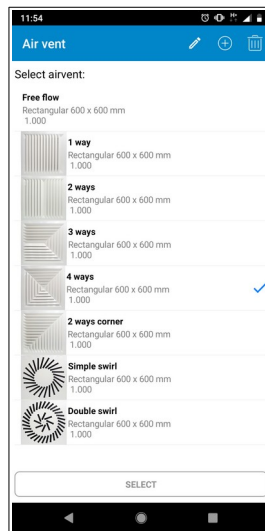

- Press **"+"** in the upper-right corner of the screen.
The following screen displays:

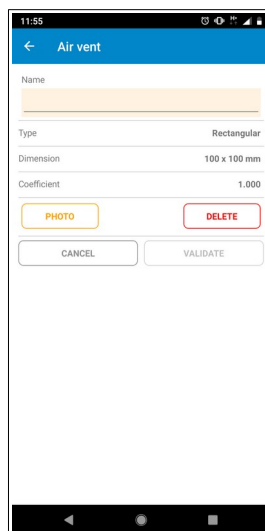

- Fill in a name.
- Select the air vent type: rectangular or circular.
- Fill in the air vent dimensions: width then length.
- Fill in a coefficient for this air vent.
- Add a photo is needed.
- Press **"Validate"**.
The created air vent appears in at the end of the available the air vents list.
- To select it:
- Press it in the available air vents list then press **"Select"**.

It is possible to modify an air vent:

- Press the air vent to modify.
- Press **"Modify"** in the upper-right corner of the screen.
- Carry out the required modifications.



For preset air vents, only the correction coefficient can be modified.

6.3.2.2 Select a standardised airflow

The standardised airflow corresponds to airflow expression according to pressure and temperature conditions as per a standard. Therefore, the airflow is re-calculated according to the measured airflow in ambient conditions (23°C/1015 hPa for instance) to take it back to standard conditions (15°C/1013.25 hPa, ISO 2533 standard).

The standardised airflow allows to obtain an airflow calculation as per DIN 1343 or ISO 2533 standard.

By default, no standardised airflow is selected.

From the measurement screen:

- Press **"Options"**.
The list of options to set displays.
- Press **"Standardised airflow"** in **"Measurement"** part.
- Select **"ISO2533"** or **"DIN1343"**.
- Press **"Validate"**.

6.3.3 Modify the air vent factors

In order to modify the air vent factors, it is possible to fill in manually a corrective coefficient which is directly applied to the measurement. For instance, with a coefficient set at 1.1, the airflow read value will be increased of 10% compared to the precedent value.

From the measurement screen:

- Press **"Options"**.
The list of options to set displays.
- Press **"Air vent"** in the **"Measures"** part.

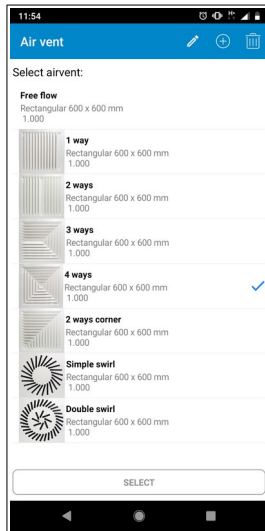

The list of available air vent types displays:

- Press the required air vent type.
- Press **"Select"** at the bottom of the screen.
- Once the air vent selected, click **"Modify"** icon on top of the screen.
The air vent features screen displays:

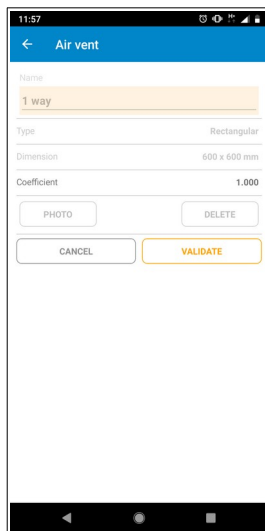

- Press **"Coefficient"**.
The following screen displays:

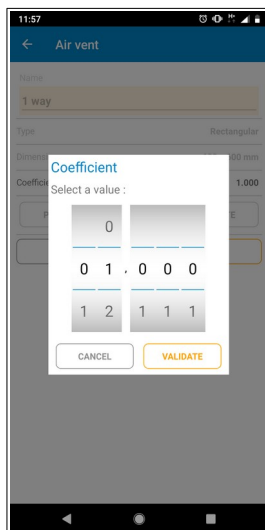

- Fill in the coefficient value.
- Press **"Validate"**.

6.3.4 Save a measurement dataset



To save a measurement dataset, the DBM 620 module must be connected via wireless connection to the smartphone or to the tablet. The previous described parameters must also be correctly filled in.

- Position correctly the air flow meter according the air vent type.
- Press **"Rec"** button.
- Press the DBM 620 module button or Press **"Validate"**.
The measurement dataset starts with its duration displayed in the upper-right corner of the screen.
- Press **"Stop"** at the required moment.

The following screen displays:

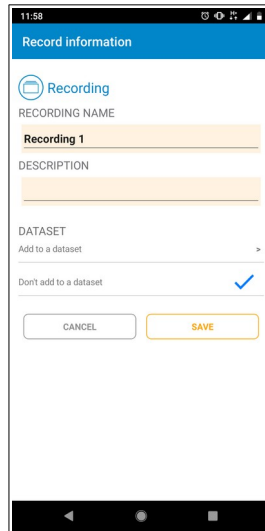

- Fill in a name and a description for this record.
- Press **"Save"** to keep only the record.
- or
- Add this record to a measurement dataset
 - Press **"Dataset"** line then select the required dataset.
 - If no dataset is saved:
 - Press **"Dataset"** line.
 - Press **"+"** button in the upper-right corner of the screen.
 - Name the dataset then validate.

6.4 Use the application in manometer mode

6.4.1 Connect the mobile device and the module

Here is the procedure to follow to connect the smartphone or the tablet via wireless connection to the DBM 620 module in manometer mode:

 Wireless connection must be activated on the smartphone or the tablet.

- Switch on the DBM 620 module by pressing the DBM 620 button.
It flashes quickly in blue.
- Launch SmartKap application.
*The application opens automatically in **"Balometer"** mode.*
- Press **"Manometer"** mode at the bottom of the screen.
- Press **"Connect a device"**.

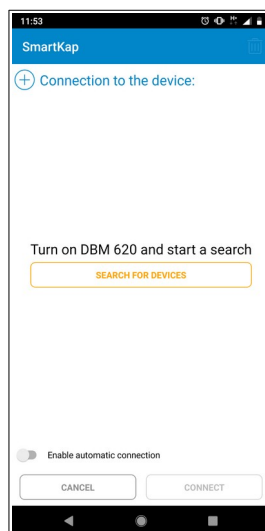

The following screen displays:

- Press **"Search devices"** at the bottom of the screen.

The smartphone/tablet searches available devices. The devices found are displayed as following:
"DBM 620 XX.XX.XX.XXXXX"

- Press the line of the required device.

A check mark appears on this line.

Click **"Connect"** in the lower-right corner of the screen.

The following screen displays:

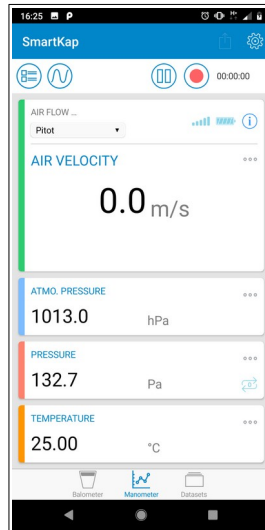

6.4.2 Set the measurements



The parameters to set are the following: the differential pressure device, type and dimensions.

6.4.2.1 Select the differential pressure device

The differential pressure device, connected to the DBM 620 module, is an element allowing the pressure measurement and determine air velocity and airflow.

From the measurement screen:

- Press **"Options"**.
The list of options to set displays.
- Press **"Differential pressure device"** in **"Measures"** part.
- Press the line of the required differential pressure device:
 - Pitot L
 - Pitot S
 - Debimo blade
 - Remote grid
- Press **"Select"** at the bottom of the screen.

From the differential pressure device selection screen, it is possible to add a customised element:

- Press **"+"** in the upper-right corner of the screen.
- Fill in a name for the differential pressure device then press **"Validate"**.
- Fill in the differential pressure device coefficient then press **"Validate"**.
This customised element appears in the differential pressure device list and it is possible to select it.

From the differential pressure device selection screen, it is possible to delete a customised element:

- Press **"Bin"** in the upper-right corner of the screen.
- Select the differential pressure device to delete.
- Press **"Delete"** in the lower-right corner of the screen.



It is not possible to delete a preset differential pressure device.

6.4.2.2 Select the air duct type and define its features

The application allows to select an air duct type (rectangular or circular) or a factor (K factor, data supplied by the air vent manufacturer) during the measurement operation in manometer mode.

From the measurement screen:

- Press **"Options"**.
The list of options to set displays.
- Press **"Type"** in **"Measurements"** part.
- Select **"Rectangular"**, **"Circular"** or **"K Factor"**.

When **"Rectangular"** or **"Circular"** has been selected, its dimensions must be set:

From the measurement screen:

- Press **"Options"**.
The list of options to set displays.
- Press **"Dimensions"** in **"Measurements"** part.
The list of available dimensions displays.
- Press **"+"** in the upper-right corner of the screen to add one.
- Fill in the width then the length for the rectangular type or the diameter for the circular one.
The dimensions are added in the list of dimensions.
- Press the line of the added dimensions.
- Press **"Select"** at the bottom of the screen.

Once the K factor selected, its value must be set:

From the measurement screen:

- Press **"Options"**.
The list of options to set displays.
- Press **"K Factor"** in **"Measurements"** part.
The list of the available K factors displays.
- Press **"+"** in the upper-right corner of the screen to add one.
- Fill in its value.
This K factor is added in the list of factors.
- Press the K factor line.
- Press **"Select"** at the bottom of the screen.

6.4.3 Set the compensation temperature and the static pressure

The compensation temperature and the static pressure allow to know the calculated parameters at defined atmospheric parameters.

6.4.3.1 Set the compensation temperature

From the measurement screen:

- Press **"Options"**.
The list of options to set displays.
- Press **"Compensation temperature"** in **"Measurements"** part.
- Fill in a compensation temperature.
- Press **"Validate"**.

6.4.3.2 Activate and set the static pressure

From the measurement screen:

- Press **"Options"**.
The list of options to set displays.
- Activate the static pressure on the **"Activate static pressure"** line.
*The **"Static pressure"** parameters become accessible.*

- Press this parameter.
- Fill in a static pressure.
- Press **"Validate"**.

6.4.4 Record a measurement dataset



To record a measurement dataset, the DBM 620 must be connected via wireless connection to the smartphone or the tablet. The previous described parameters must also be correctly filled in.

Three dataset types are available:

- **Automatic:** records the average value, the minimum and maximum values and the standard deviation measured by the device during the measurement dataset
- **Point by point:** records the average value, the minimum and maximum values and the standard deviation measured by the device on different measurement points defined by the user.
- **Automatic point by point:** records the average value, the minimum and maximum values and the standard deviation measured by the device on different measurement points defined by the user and on a defined period for each measurement point.

6.4.4.1 Save an automatic dataset

- Position correctly the differential pressure device on the required location.
- Press **"Rec"**.

The following screen displays:

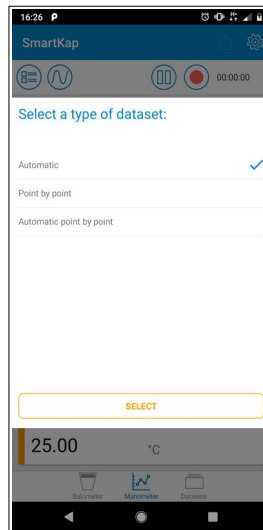

- Press **"Automatic"** then **"Select"** at the bottom of the screen.
The measurement dataset starts: its duration displays in the upper-right corner of the screen.
- Press **"Stop"** in the upper-right corner of the screen when the required duration of the dataset is reached.
The following screen displays:

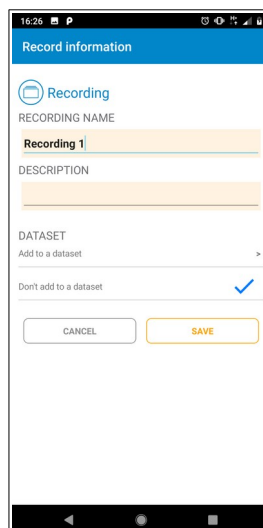

- Fill in a name and a description for this record.
- Press **"Save"** to only keep the record.
- or
- Add this record to a measurement dataset:
 - Press **"Dataset"** line then select the required dataset.
 - If no dataset is saved:
 - Press **"Dataset"** line.
 - Press **"+"** button in the upper-right corner of the screen.
 - Name the dataset then validate.

6.4.4.2 Save a point by point dataset

- Position correctly the differential pressure device at the required location.
 - Press **"Rec"** button.
- The following screen displays:*

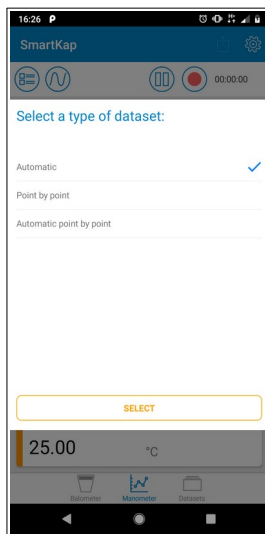

- Press **"Point by point"** then **"Select"** at the bottom of the screen.
 - Press **OK** each time that a measurement point need to be recorded.
 - Press **"Stop"** in the upper-right corner of the screen when the required number of measurement points is reached.
- The following screen displays:*

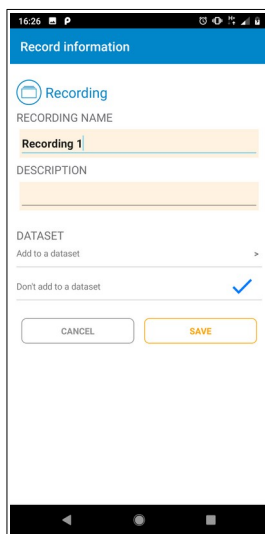

- Fill in a name and a description for this record.
- Press **"Save"** to only keep the record.
- or
- Add this record to a measurement dataset:

- Press **"Dataset"** line then select the required dataset.
If no dataset is saved:
- Press **"Dataset"** line.
- Press **"+"** button in the upper-right corner of the screen.
- Name the dataset then validate.

6.4.4.3 Save an automatic point by point dataset

- Position correctly the differential pressure device on the required location.
- Press **"Rec"**.

The following screen displays:

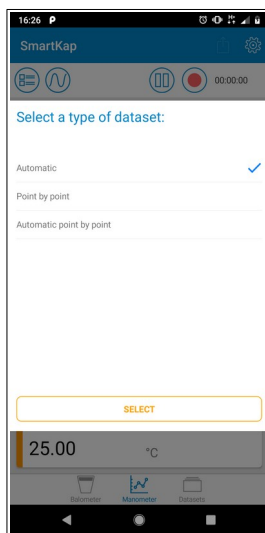

- Press **"Automatic point by point"** then **"Select"** at the bottom of the screen.

The following screen displays:

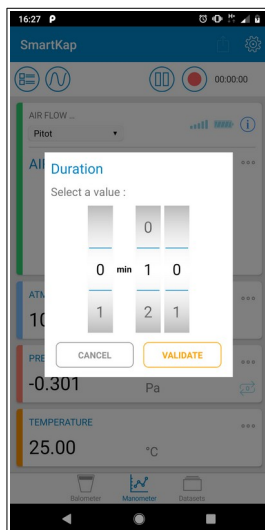

- Set the duration between each measurement then press **"Validate"**.
- Press **OK** in the upper-right corner of the screen.
The device carries out a measurement point during the defined period.
- Press **OK** each time a measurement point must be recorded.
- Press **"Stop"** in the upper-right corner of the screen when the required number of measurement points is reached.

The following screen displays:

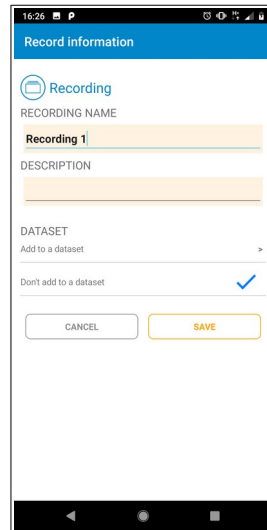

- Fill in a name and a description for this record.
- Press **"Save"** to only keep the record.
- or
- Add this record to a measurement dataset:
 - Press **"Dataset"** line then select the required dataset.
 - If no dataset is saved:
 - Press **"Dataset"** line.
 - Press **"+"** button in the upper-right corner of the screen.
 - Name the dataset then validate.

6.5 Set the correction coefficient

The correction coefficient is a calculation factor which allows to "smooth" measurement. The principle is the following: The correction coefficient can be modified on the range from 0 to 9. When the factor is set on 9, it takes 90% of the previous value on which are added 10% of the current value. Therefore, the measurement "smoothing" is more or less important according to the defined value.

To set this factor:

From the measurement screen:

- Press **"Options"**.
The list of options to set displays.
- Press **"Integration"**.
- Select a value between 0 and 9.
- Press **"Validate"**.

6.6 Modify the measurement units

The application allows to modify the units for each parameter used by the DBM 620. These parameters and their corresponding units are:

- Temperature: °C, °F
- Pressure: Pa, mmH₂O, mmHg, inWg
- Atmospheric pressure: hPa, mbar
- Air velocity: m/s, fpm, km/h, mph
- Airflow: m³/h, L/s, cfm
- Distance: mm, in

From the measurement screen:

- Press **"Options"**.

The list of options to set displays.

- Press the line of the parameter to modify.
- Select the required unit.
- Press **"Select"** at the bottom of the screen.

6.7 Fill in operator information

The application allows to fill in information on an operator.

From the measurement screen:

- Press **"Options"**.
The list of options to set displays.
In **"Operator"** part:
- Fill in the Name, First name, Company, Address, Town, Email and Phone fields.
- Add a logo if required.



Operator information is automatically reported when generating pdf measurement reports.

6.8 Manage measurements records and datasets

Measurements records only or measurement records integrated to a dataset are available from the application. It is then possible to visualise values under table or graphic form and export them under different formats.

6.8.1 Access the measurement records and datasets



One measurement record or dataset must at least be saved.

From the measurement screen:

- Press **"Datasets"** in the lower-right corner of the screen.
The following screen displays:

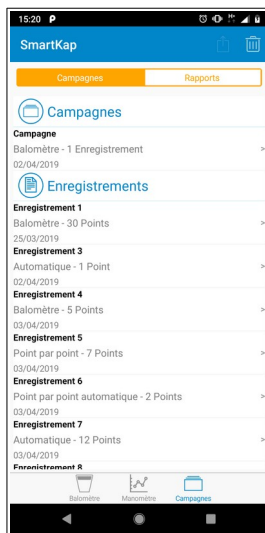

- Press the required record in **"Records"** part.
or
- Press the required dataset, the list of records in this dataset opens, press the required record.

The recorded values display:

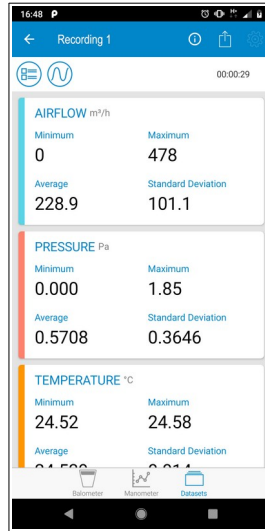

➤ Press **"Table"** or **"Graphic"** icon to display the values table or graphic:

Date and hour	m ³ /h	Pa	°C	%RH
25/03/2019 11:31:11	478	1.85	24.52	33.29
25/03/2019 11:31:10	253	0.609	24.52	33.20
25/03/2019 11:31:09	207	0.406	24.54	33.09
25/03/2019 11:31:08	252	0.603	24.54	33.09
25/03/2019 11:31:07	288	0.758	24.56	33.23
25/03/2019 11:31:06	256	0.619	24.52	33.31
25/03/2019 11:31:05	270	0.678	24.54	33.43
25/03/2019 11:31:04	290	0.768	24.54	33.43
25/03/2019 11:31:03	264	0.652	24.53	33.39
25/03/2019 11:31:02	133	0.166	24.54	33.13
25/03/2019 11:31:01	154	0.223	24.54	33.07
25/03/2019 11:31:00	288	0.757	24.54	33.04

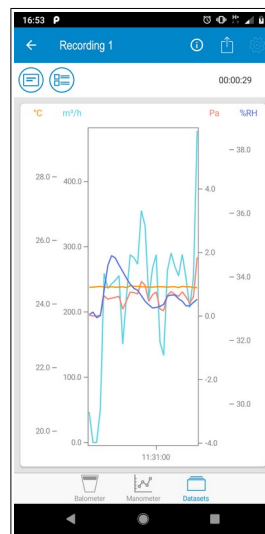

6.8.2 Export the values



A record must be opened.

➤ Press **"Export"**.
The following screen displays:

The screenshot shows the 'Export' screen with the following fields:

- Customer information (with a 'CLEAR INFORMATIONS' button)
- Last name
- First name
- Company
- Address
- City

- Fill in the customer information.
- Information about operator previously filled in will be automatically reported when generating measurement reports.
- Fill in a comment.
- Define the measurement reports specificities:
 - Title
 - Type of report: pdf, csv or xml
 - Type of elements to integrate in the report: table of values, graphic, sum of averages and room volume.
 - Photos
- Press **“Export”** button.
The report opens.
- Save this report in your smartphone or tablet.
And/or
- Send or share this report.

6.8.3 “Air Change Rate” function (ACR)

The ACR function allows to know the air change rate in the room according to the room volume and the measured airflow. Therefore, the air change rate corresponds to the measured airflow average divided by the volume of the room.



A record must be opened.

- Press **“Export”** (see page 35 for the complete procedure to export measured data).
- In the measurement report specificities, select the elements to integrate to the measurement report and fill in the room volume in m³.
- Press **“Export”**.
The report opens.
- Save this report in the smartphone or the tablet.
And/or
Send or share this report.

6.8.4 Example of pdf report

Customer information		Operator information	
Name Fédéric Dubois	Company Xxxxxxx	Name Jean DUPONT	Company SAUERMANN
Address 10 rue de la sagesse 75000	City Paris	Address 15 rue de la Liberté 75005	City Paris
Phone 0550010203	Email f.dubois@xxx.com	Phone +33123456789	Email jean.dupont@sauermann.fr

Sum of average airflow 444.3 m ³ /h	Renewal rate 1	Room volume 300 m ³
---	-------------------	-----------------------------------

1. Name and date of the measurement record (present on each page)
2. Customer information
3. Operator information
4. Eventual comments
5. Measurements recap:
 - Sum of average airflow in m³/h
 - Air renewal rate of the room
 - Room volume in m³

Record 1
07 May 2019

Record information

Name
Erregistrement 1 1

Description

Date
07/05/2019

Duration
00:02:08

Device informations

Name
DBM620

Serial number
3P 18.10.03560

Version
0.80 (b661)

Calibration date
18/04/2019 2

Measure parameters

Alerts name
Essai ss corr 3

Standardized airflow
None

Type
Rectangular

Dimension
600 x 600 mm

Coefficient
1

Statistics	Airflow [m ³ /h]	Pressure [Pa]	Temperature [°C]	Hygrometry [NRH]
Minimum	434	1.68	21.07	49.32
Maximum	450	1.80	21.15	49.77
Average	444.3	1.758	21.111	49.527
Standard Deviation	2.9	0.0217	0.014	0.128

sauermann DBM 620 - SmartKap App 2/9

1. Record information
2. Device information
3. Measurement parameters

Record 1
07 May 2019

Values table 1

Date	Airflow [m ³ /h]	Pressure [Pa]	Temperature [°C]	Hygrometry [NRH]
07/05/2019 10:31:31	434	1.68	21.10	49.72
07/05/2019 10:31:32	438	1.71	21.11	49.75
07/05/2019 10:31:33	442	1.74	21.13	49.74
07/05/2019 10:31:34	445	1.76	21.13	49.77
07/05/2019 10:31:35	445	1.76	21.10	49.75
07/05/2019 10:31:36	447	1.78	21.11	49.74
07/05/2019 10:31:37	447	1.77	21.10	49.77
07/05/2019 10:31:38	445	1.76	21.13	49.71
07/05/2019 10:31:39	442	1.74	21.11	49.74
07/05/2019 10:31:40	442	1.74	21.11	49.75
07/05/2019 10:31:41	444	1.75	21.07	49.71
07/05/2019 10:31:42	444	1.75	21.13	49.73
07/05/2019 10:31:43	444	1.76	21.11	49.71
07/05/2019 10:31:44	445	1.77	21.11	49.75
07/05/2019 10:31:45	447	1.78	21.11	49.67
07/05/2019 10:31:46	445	1.76	21.11	49.68
07/05/2019 10:31:47	450	1.80	21.11	49.70
07/05/2019 10:31:48	450	1.80	21.09	49.69
07/05/2019 10:31:49	450	1.80	21.11	49.72
07/05/2019 10:31:50	449	1.79	21.11	49.72
07/05/2019 10:31:51	447	1.78	21.10	49.71
07/05/2019 10:31:52	444	1.76	21.13	49.70
07/05/2019 10:31:53	444	1.76	21.10	49.70
07/05/2019 10:31:54	445	1.77	21.10	49.70
07/05/2019 10:31:55	445	1.76	21.11	49.68
07/05/2019 10:31:56	448	1.79	21.11	49.67
07/05/2019 10:31:57	447	1.78	21.10	49.63
07/05/2019 10:31:58	446	1.77	21.10	49.66
07/05/2019 10:31:59	446	1.77	21.10	49.62

sauermann DBM 620 - SmartKap App 3/9

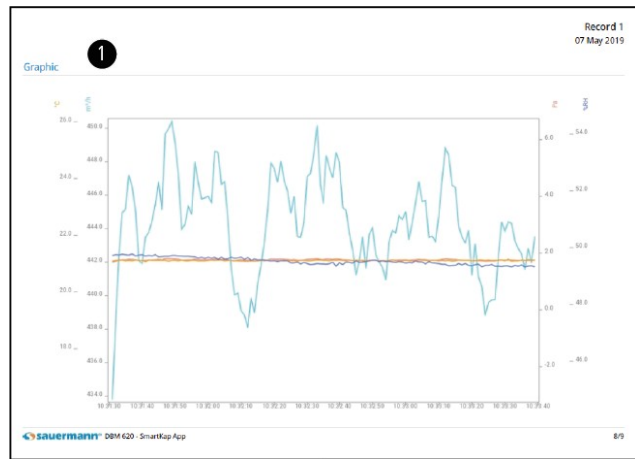

1. Graphic

1. Table of values

Record 1
07 May 2019

Attachments 1

sauermann DBM 620 - SmartKap App 9/9

1. Attachments

