

 **sauermann**[®]

KIMO[®]
INSTRUMENTS

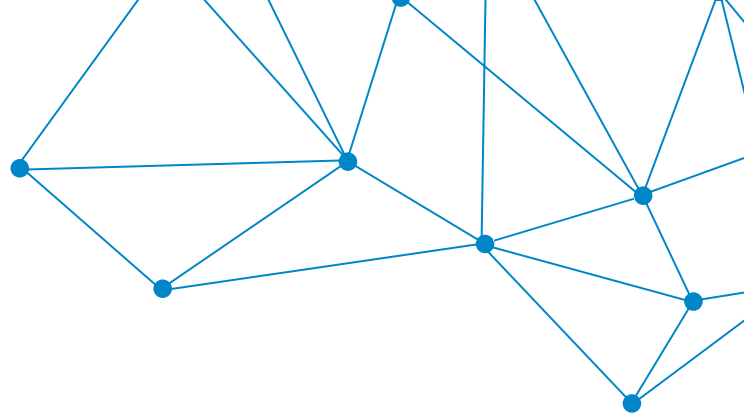

AIR CONDITIONING AND VENTILATION

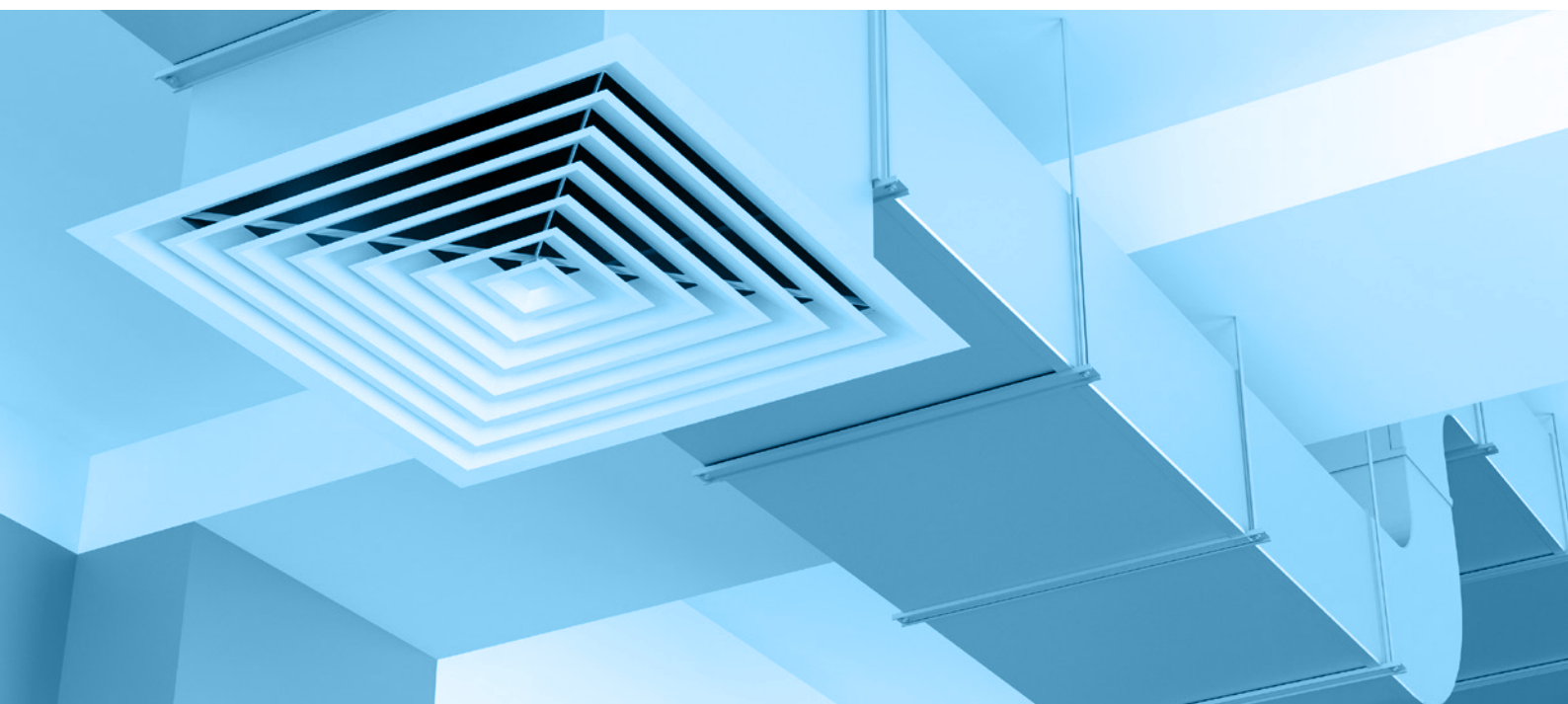

ABOUT US



For more than 45 years, Sauer mann Group has designed, manufactured and sold products and services dedicated to the industrial and HVACR markets. The Group specifically focuses on the detection, measurement and control of indoor air quality (IAQ).

sauer mann®



Sauer mann Group operates two main brands:

- The **Sauer mann** brand, through condensate removal pumps, instruments and accessories, primarily addresses the needs of Heating, Ventilation, A/C or Refrigeration contractors.
- The **Kimo** brand, through measuring instruments, meets the air management needs in light commercial and industrial installations.

HIGH ACCURACY
UNMATCHED RELIABILITY
MULTIPLE APPLICATIONS

Measurement instruments: Sauer mann measurement instruments monitor a broad spectrum of indoor air quality parameters and serve a wide range of applications, from building ventilation (heating and air conditioning) systems, to cold-chain installations and combustion gas analysis. Backed by our testing laboratories and in-house research and development programme, Sauer mann instruments deliver the accuracy and reliability that HVACR engineers need.

LOW SOUND LEVEL
LOW FAIL RATE
HIGH PERFORMANCE

Condensate management solutions: Safe and effective condensate management for air quality systems can be a challenge. Sauer mann pumps are designed to look good, while our patented piston technology delivers whisper-quiet operation and unrivalled reliability.



North America

● Sauer mann N.A. Corp.,
New York, Langhorne, USA

**EMEA – Europe,
Middle East & Africa**

● Si Invest SA,
Brussels, BELGIUM

● Sauer mann Industrie S.A.S,
Chevy-Cossigny,
Montpon, FRANCE

● Sauer mann GmbH,
Leingarten, GERMANY

● Sauer mann UK Ltd.,
Blackpool, UNITED KINGDOM

● Sauer mann Iberica,
Barcelona, SPAIN

● Sauer mann Italia S.r.l,
Bologna, ITALY

Asia Pacific

● Sauer mann China,
Shanghai (Jiading & Pudong),
CHINA

● Sauer mann Australasia,
Sydney, AUSTRALIA

SUMMARY



MONITORING AND
REGULATION

06

DATA LOGGING

14



COMMISSIONING,
VALIDATION AND
MAINTENANCE

20

About us 02

**Ventilation
and air conditioning** 04

Maintaining ideal climatic conditions
inside buildings. 04

Monitoring and regulation 06

Multifunction 08
Temperature and humidity 09
Pressure 10
Air velocity and air flow 12
Carbon dioxide 13

Data Logging 14

All parameters 16

**Commissioning,
validation and maintenance** 20

Multifunction 22
Air velocity and air flow 26
Differential pressure 28
Temperature and humidity 29
Air velocity and air flow 30
CO₂ 32
Tachometry 33

Products and accessories 34

Our expertise 47

For more information 48

AIR CONDITIONING AND VENTILATION

Maintaining ideal climatic conditions inside buildings

These days, managing indoor air is a key concern across many sectors and industries. Sauer mann offers a wide range of measurement solutions – spanning all air quality parameters in every part of a building and its ventilation system – to help keep conditions perfect for occupants and manufactured and stored products alike.

Managing the aeraulic network

VAC systems cover every part of the air supply, processing and distribution chain in buildings. That's why Sauer mann's measurement instruments come in various fixed, stand-alone and portable versions, making them suitable for use at any point in the circuit: from the building management system (BMS) and air treatment units, to fans, pipes, filters, vents, diffusers and more.

For every type of building

Every type of building needs a properly managed ventilation and air conditioning system, whether it's a factory, a warehouse, an office block or a residential property. For this reason, Sauer mann's instrument ranges, which are sold directly and through its distribution partners, are segmented to make it easier for professionals working in different sectors to choose the right products – from quick, easy-to-use instruments for homes and small-scale commercial properties, to higher-capacity instruments for more critical applications.

Supporting the fight against pathogens

The COVID-19 pandemic has underscored the vital role of VAC systems in buildings. Air change rate (ACR) has become a key parameter in healthy and safety policies, with recommendations setting a universal limit of 800 ppm of CO₂ in order to prevent the spread of bacteria and viruses. Sauer mann has a 45-year track record in measuring key parameters for calculating and monitoring air change rate and air filter fouling, and its instruments are widely used in critical buildings such as hospitals and other health-care settings.

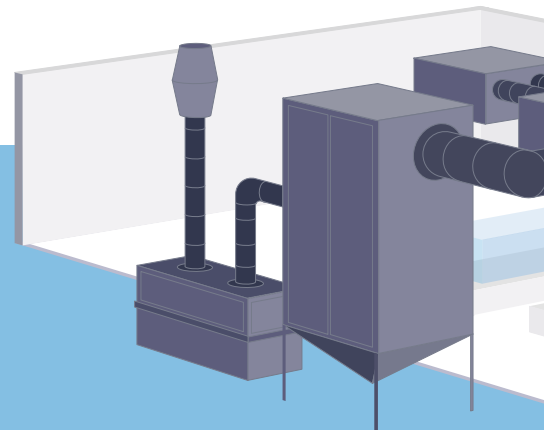

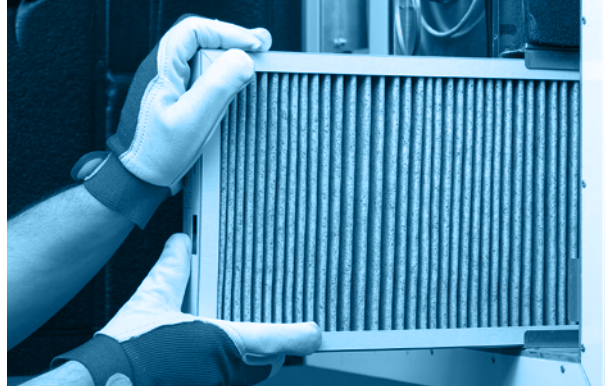

Air flow dynamics and air properties

A building's ventilation system is responsible for managing both air flow dynamics (air velocity and flow rate) and air properties (temperature, humidity, CO₂ concentration and pressure). Sauermann's instruments measure all these parameters with a high degree of reliability and accuracy, backed by calibration certificates issued by specialist in-house laboratories.

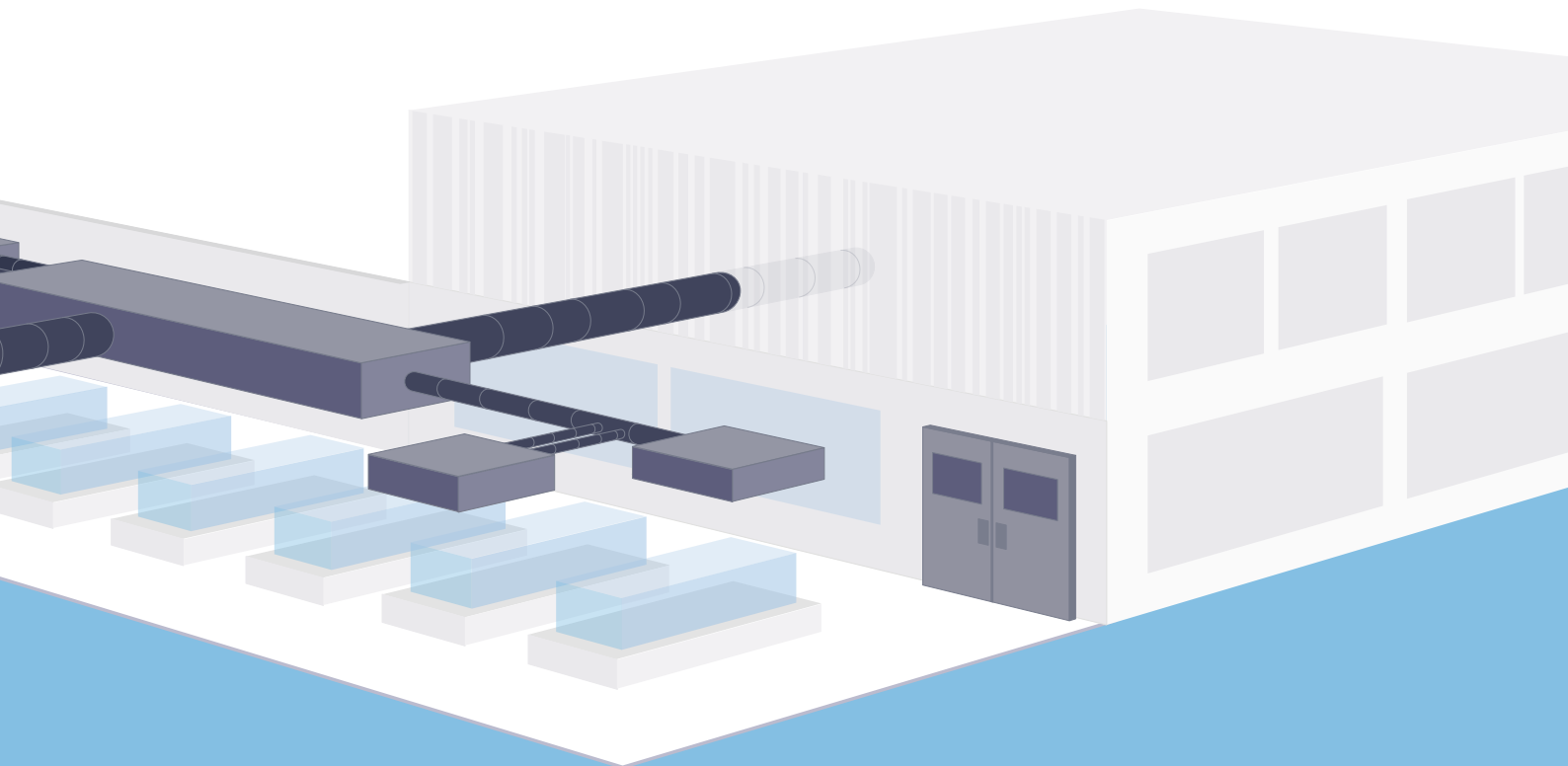

MONITORING AND REGULATION

In critical settings, ventilation systems need to be monitored around the clock to make sure indoor air is being managed as optimally as possible. Here, monitoring involves preventing and detecting breakdowns and malfunctions of the air conditioning system. Measuring instruments also enable real-time regulation of the entire air conditioning system in a building, room by room.

This application requires multifunction transmitters, or transmitters specially designed to measure a specific parameter.

The regulation process therefore forms part of the Building Management System. In addition, it relies on SCADA (Supervisory Control and Data Acquisition) systems – a computerised environment that also optimises the building's energy use by analysing data collected by our measurement instruments.

That's why Sauer mann's transmitters are open by design, meaning they have standard outputs – both analogue and digital. And our transmitters offer the ultimate in flexibility when it comes to BMS topology, structure and configuration.

The aim is to regulate air quality parameters non-stop and around the clock, to achieve flawless indoor air quality management and to support preventive maintenance of the ventilation system.

The awareness about **indoor air quality** has become one of the pillars of the developments of the **HVACR industry**. The impact that the design, control and maintenance of **VAC systems** have on each individual's health and well-being is known. It does have a direct influence on the energy efficiency too. Creating the best indoor air conditions following specific guidelines is the main goal of regulations like the **ANSI/ASHRAE Standard 62.1**. With a given set of specific procedures and engineering methods, the ANSI/ASHRAE Standard 62.1 provides the tools to design and manage VAC systems in non-residential buildings, delivering the utmost air quality. The continuous analysis of the key air parameters **through measuring** is an essential part to succeed in such important challenge. **Sauer mann's instruments** have been designed to help you reaching this goal.



Air conditioning system of a shopping center in Zurich - ©balakate/123RF.COM

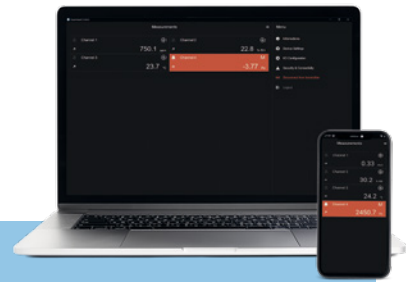

LCC-S software and Sauer mann Control application:

Our manostats, class 110 and class 210 transmitters can be easily configured with any specific settings using the optional configuration software. This tool allows the users to get the most suitable performance out of any Sauer mann's transmitters. The software also displays the actual measurements in real time and allows to manage the outputs when needed.

The Class 320 transmitters can be controled and configured with a computer, a smartphone or a tablet via the Sauer mann Control application, which allows the user to manage all the device's parameters via its wireless connection module (USB wired for computers). This app can also easily update the firmware of the instrument and its probes.



Monitoring and regulation

Multifunction transmitters

Sauermann's multifunction transmitters are great to measure differential pressure and psychrometric parameters simultaneously in specific VAC applications. These premium instruments deliver unmatched reliability and are built to withstand the test of time.

Measuring differential pressure is especially important in buildings, helping to monitor filters in aeraulic networks. Some of these filters are HEPA or ULPA models, which are designed to remove airborne mi-

cro- and nano-particles including bacteria and viruses. Filters' efficiency decreases quickly as they get clogged, meaning they need to be monitored constantly for replacement planning purposes.

These multifunction measurement instruments can also accommodate one or more additional probes for monitoring extra parameters (differential pressure, temperature/humidity, air velocity and air flow, and CO/CO₂/VOC concentration).



For monitoring and regulating dynamic pressure, temperature and humidity and other psychrometric parameters in air handling units.

Solution
Si-C320-D-1000
and Si-PRO-U-I-150 probe

For monitoring and regulating air velocity and air flow in ducts downstream of air handling units.

Solution
Si-C320-D

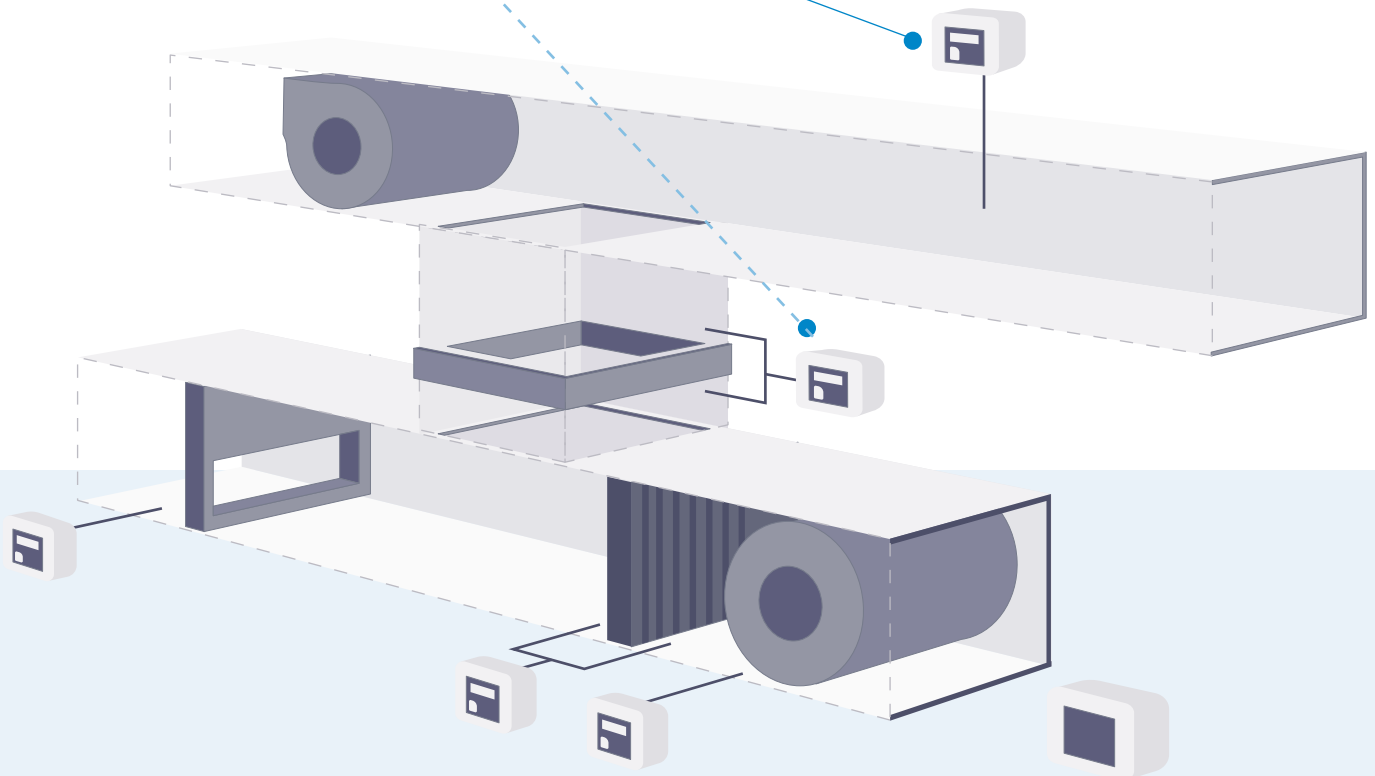

Monitoring and regulation

Temperature and humidity

Temperature and relative humidity are the key indicators of the climatic conditions inside a building. They are essential to both occupant comfort and the preservation of products in store rooms.

The regulation of these parameters is therefore vital not only for health and quality purposes, but also for financial reasons, since regulating temperature and humidity is essential to achieve the energy efficiency standards set by recent environmental regulations. Likewise, effective monitoring helps to identify weak points in a building's insulation.

Sauermann has been supplying temperature and humidity transmitters for 45 years. All our models undergo strict reliability checks for both parameters before leaving our factories, with the results certified by our ISO 17025:2017-accredited laboratories in France. Buildings of all types rely on our expertise for indoor air regulation: factories, warehouses, museums, schools, hospitals, offices and more.



For regulating air temperature and humidity downstream of air handling units.

Solution
TH 110



For regulating air temperature downstream of air treatment units.

Solution
TM 110 with autonomous temperature probe

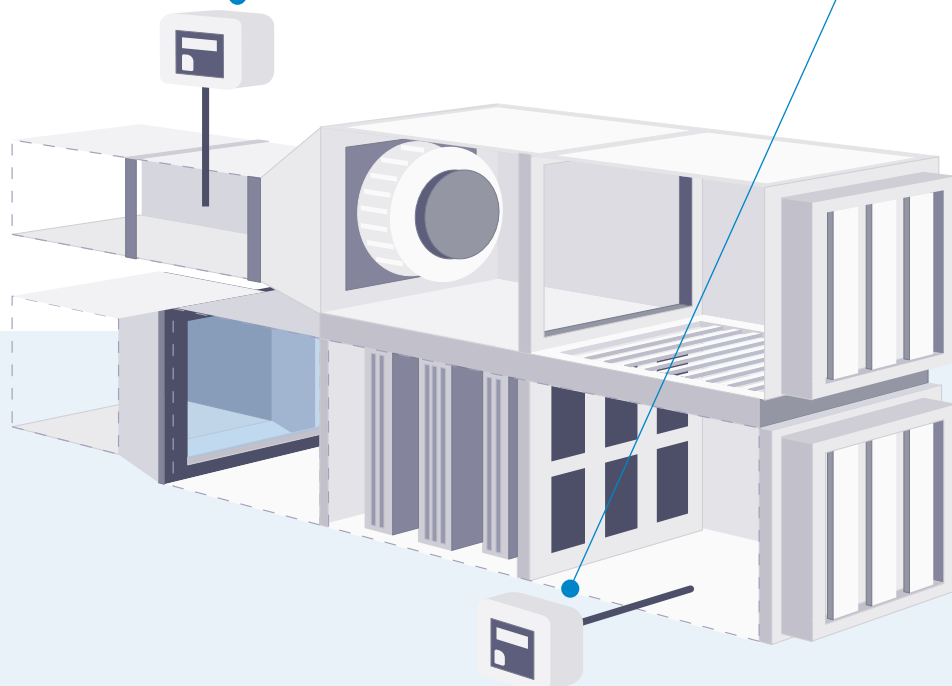

Monitoring and regulation

Pressure

Measuring differential pressure is especially important in monitoring the performance of air treatment units. These measurements are taken at air filters and ducts, where differential pressure measurements can be used to deduce the air flow rate.

The filters inside air treatment units get clogged at different rates depending on their filtration efficiency. Constant monitoring is vital for antibacterial HEPA and ULPA filters in particular.

Differential pressure values taken between both sides of a filter indicate the extent of clogging and help to determine when the filter needs to be replaced as part of preventive maintenance planning – the process by which maintenance work is scheduled at the most appropriate moment in order to reduce or eliminate downtime.

Building on its long-standing expertise in pressure measurement instruments, Sauermann's solutions – connected digital manometers and liquid column manometers – cover the complete range of applications. Our digital manometers are ideal for recording values remotely and over time. All models feature a visual and audible alarm, and some come with an integrated display. Meanwhile, our liquid column manometers set new standards for durability and work without power supply, which makes them exceptionally resilient.



For monitoring and regulating differential and dynamic pressure downstream of air treatment units.

Solution
CP 112

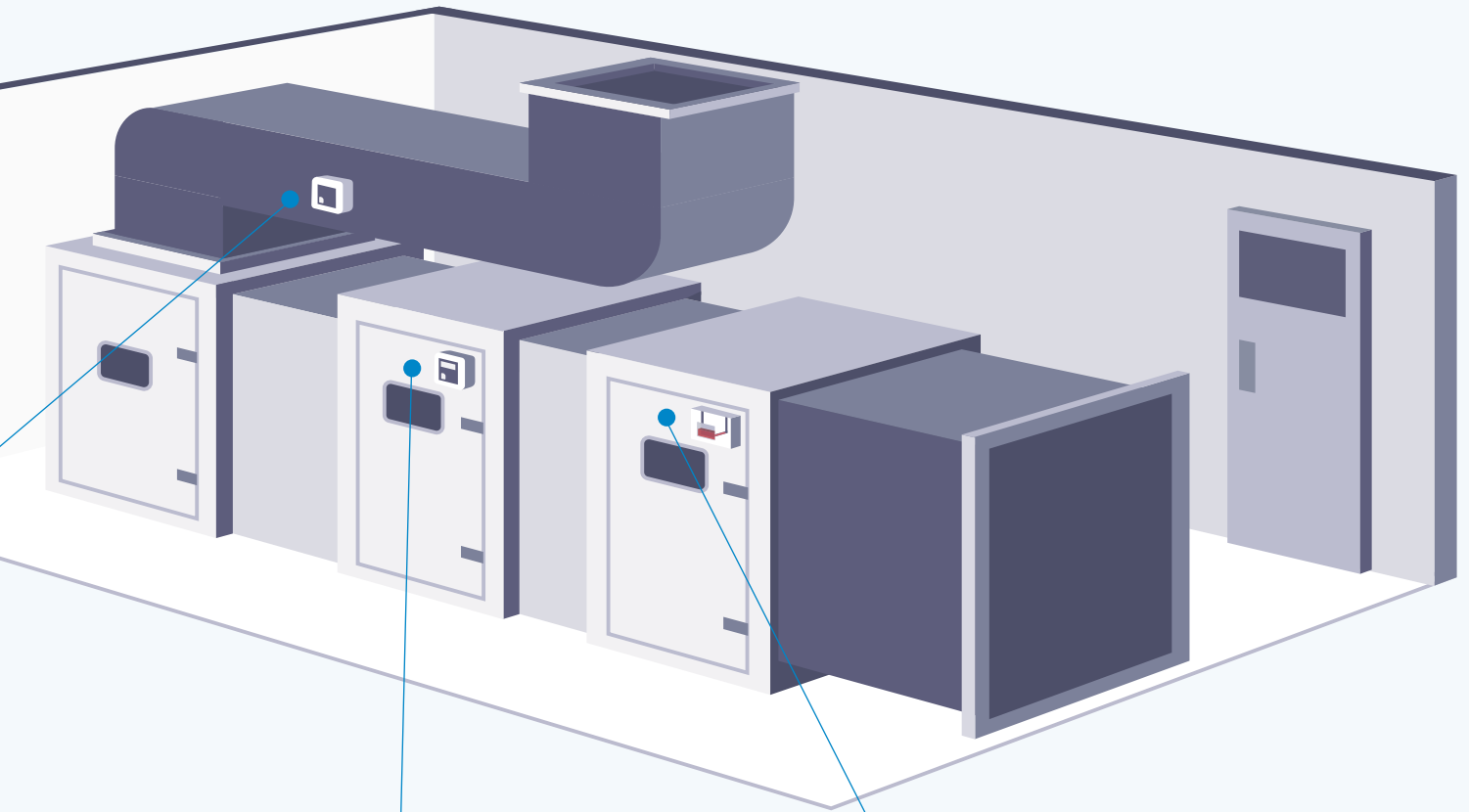

For monitoring and regulating differential pressure at air filters in ventilation systems, triggering an alarm when filter clogging is detected.

Solution
PST-12
PST-13



For monitoring and displaying pressure readings at air filters in air treatment units, indicating a loss of pressure in the event of filter clogging, and operating without a power source.

Solution
MG 50
MG 80

Monitoring and regulation

Air velocity and air flow

Monitoring air velocity and flow rate helps to ensure that air is circulating properly in air-conditioned buildings. And crucially, it gives an indication as to whether the air change rate is sufficient in parts of the building where this is necessary.

Having a regular circulation of fresh air is essential to keep the climate constant, especially in rooms containing equipment that radiates heat such as machines, power supply units and microcomputers. In other instances, it helps to remove cold air or chemicals released by particular products.

That's why Sauermann has developed advanced instruments for monitoring and recording air velocity and flow rate values in ventilation system pipes, covering both inlets and outlets. Our solutions also include DEBIMO blades, a renowned technology for calculating air exchange volumes in ventilated premises in real time.

DEBIMO blades: custom-built for perfection

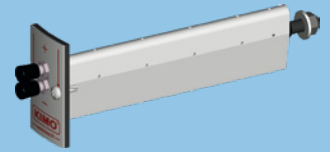

Sauermann's DEBIMO blades allow our differential pressure transmitters to calculate the air velocity and air flow. The principle behind this technology is the flow device element, which is based on the concept of differential pressure. This ultra-reliable and hard-wearing device is specially designed to monitor and regulate air flow dynamics in ventilation system ducts without disturbance (almost zero pressure drop and turbulence). Sauermann can quickly manufacture custom DEBIMO blades in its factories, in order to fit into specific ducts and constraints.



For monitoring and regulating temperature and air velocity in all types of ventilation system ducts.

Solution
CTV 110



For monitoring and regulating air velocity and air flow in ventilation system ducts downstream of air handling units.

Solution
CP 210-R with DEBIMO blades

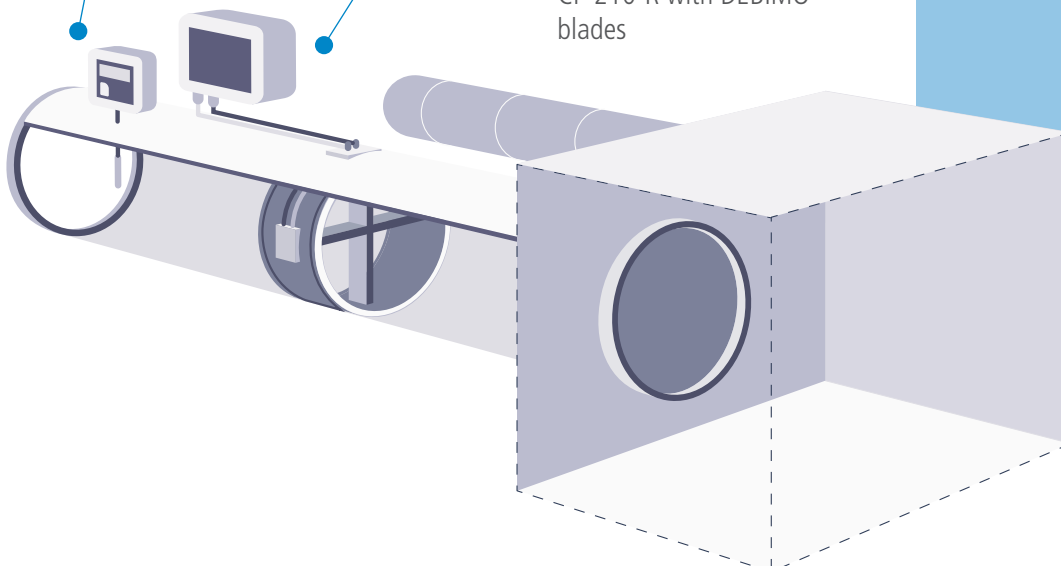

Monitoring and regulation

Carbon dioxide

Because CO₂ concentration the environment is an important indicator of the indoor air quality, it is a key parameter in determining the overall and ultimate efficiency of a building's ventilation system.

CO₂ concentration can be measured quickly and in real time, but capturing reliable measurements requires high-end CO₂ sensors. Sauermann's technology is totally reliable: non-dispersive infrared (NDIR) sensors integrated into instruments that are calibrated by our in-house metrological service.

CO₂ measurement is no longer exclusive to the most critical buildings. In fact, it is highly recommended in all public premises, including schools and offices. Scientists currently agree that a CO₂ concentration between 800 and 1,000 ppm indicates a sufficient air change rate to reduce the concentration of bacteria and viruses suspended in the air, thereby mitigating the potential spread of airborne pathogens.



For monitoring CO₂ concentration in the air circulating through air extraction ducts, enabling the Building Management System to regulate air flow in the ventilation system and keep the indoor air clean.

Solution
CO 112

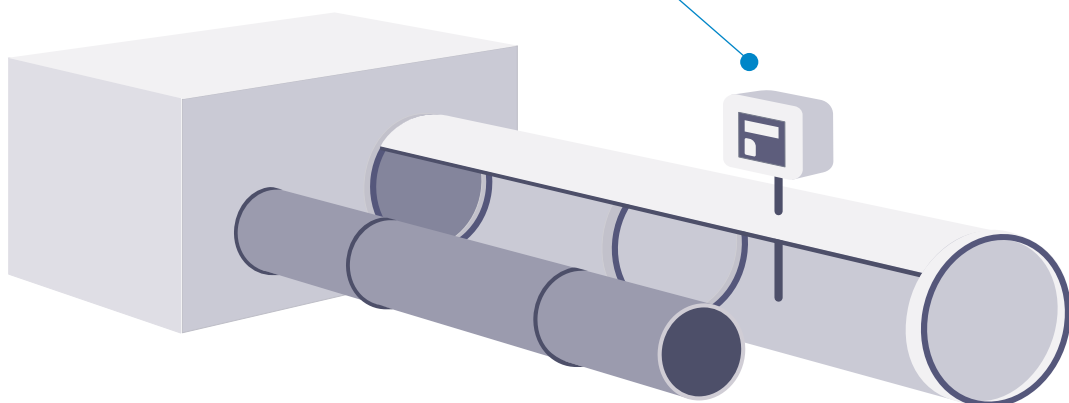

DATA LOGGING

All commercial buildings, especially public venues, are subject to indoor air quality standards and recommendations. In order to meet these requirements, indoor air quality needs to be monitored regularly – or even around the clock – so that any problems with the building’s ventilation system can be detected and reported.

Often, this monitoring task is performed by data loggers – fully autonomous instruments with a large internal memory and an integrated battery for power. These devices keep tabs on air parameters in a particular area. They can also operate as a grid, monitoring all the air inside a room and providing an overview of how the ventilation system is performing.

- **Everyday monitoring on the fly**
- **Long-term mapping studies**

Our autonomous data loggers are small, lightweight portable and highly easy-to-use instruments designed for easy installation in any location and long-lasting operation. Readings can be downloaded to the accompanying software wirelessly or via USB in order to generate comprehensive measurement reports.

These instruments can also be used to generate a detailed map of specific parts of a building, in order to check air parameter uniformity within an entire space and over an extended period.





KISTOCK Mobile: App for class 320 autonomous data loggers

This free app for Android and iOS devices pairs wirelessly with our data loggers for complete control:

- Supports an unlimited number of instruments
- Manage and configure data loggers remotely
- View readings in real time
- Display measurements as graphs and charts
- Generate PDF or spreadsheet measurements reports



Mobile application

- Wireless pairing
- Data visualisation
- Free download



Data logging

All parameters

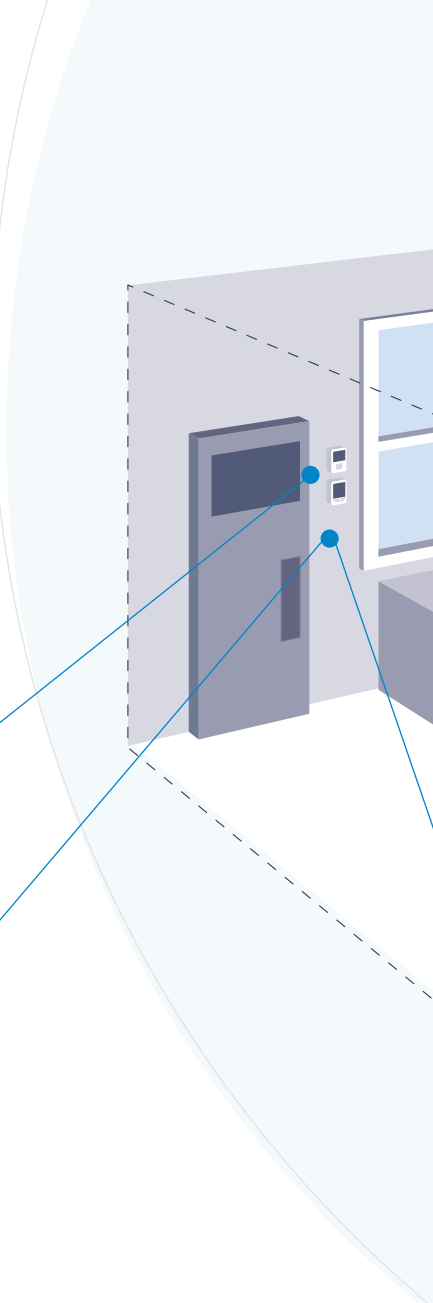

Takes indoor air temperature and humidity readings in a room in a public building for ventilation system performance monitoring.

Solution
Kistock KH 50, KH 220
or KT 320 with KITHA probe

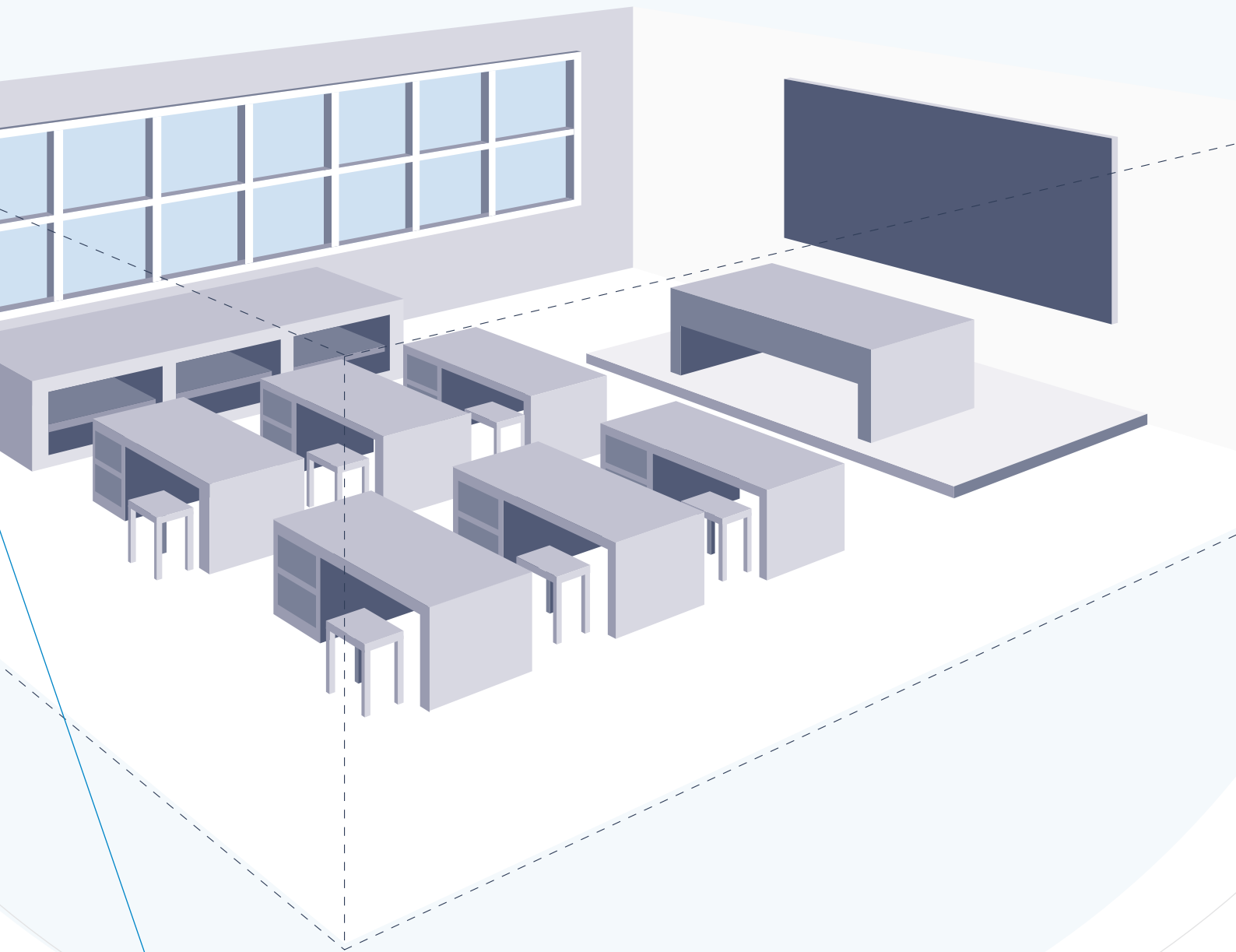

Monitors and records CO₂ concentrations over time, indicating the air change rate achieved by the ventilation system.

Solution
Kistock KCC 320

All parameters

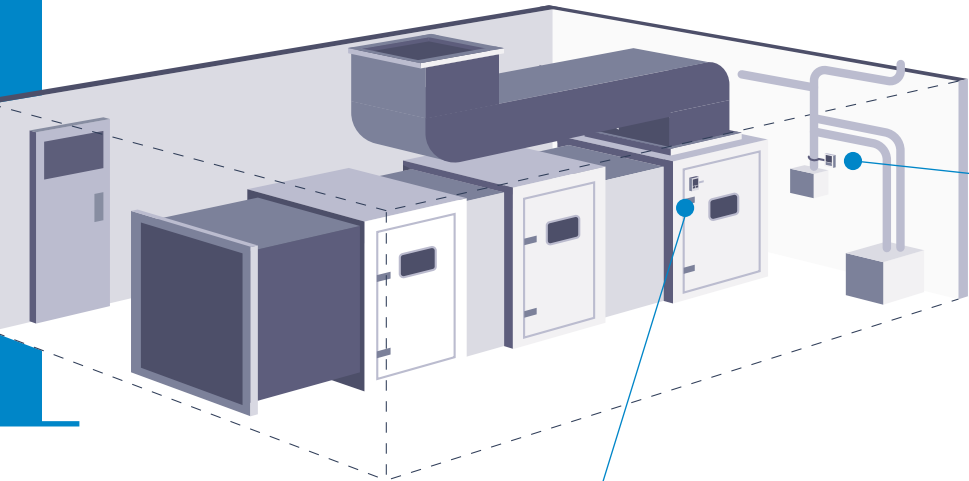

This data logger is installed on a pipe downstream of an air treatment unit. The probe with its hook and loop fastener system holds the thermocouple sensor in direct contact with the outer wall of the pipe.

Solution
Kistock KT 320 with KIRV-320 probe



Records the temperature and humidity of the air inside pipes in plant rooms and technical spaces.

Solution
Kistock KT 220 with KTHD probe

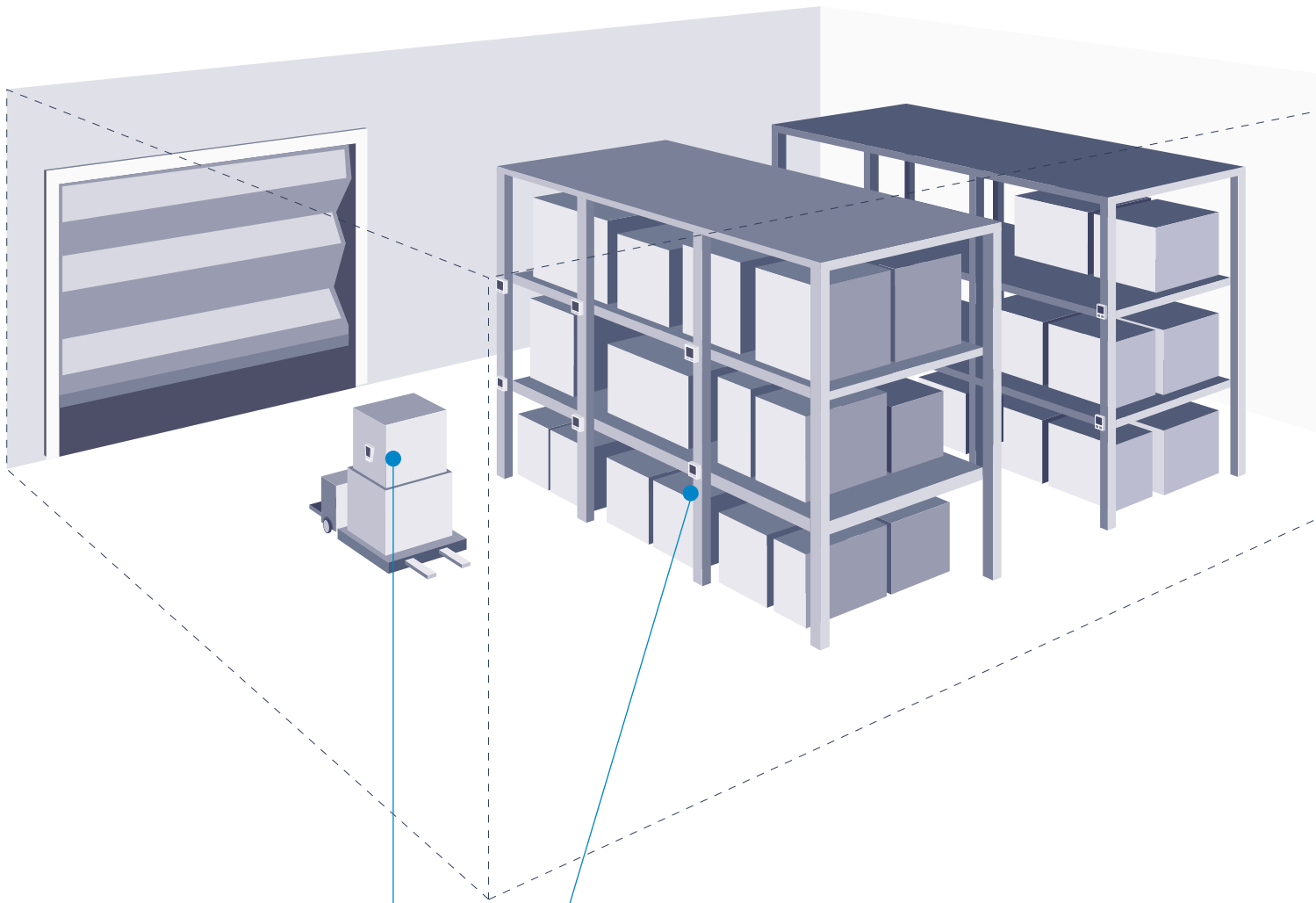

These data loggers are used to monitor the temperature inside a warehouse. Typically, several instruments are placed in different locations to produce a detailed thermal mapping of the warehouse (up to three temperature probes per instrument).

Solution

Kistock KT 50 or KT 120

COMMISSIONING AND MAINTENANCE

HVAC engineers are involved at various stages in the life of a ventilation system – starting with the commissioning phase, when system tuners check that all the components are designed, installed, tested and used in a way that meets the operational specifications set by the project managers and the customer. These vital checks ensure that the ventilation system operates as efficiently as possible right from the outset.

Engineers will need to return to work on the ventilation system at regular intervals – from carrying out statutory inspections to servicing and maintaining the entire system. This process involves measuring all air parameters in order to detect even the slightest problem or defect, with clogged filters being the most common issue.

Preventive maintenance can help to extend the lifespan of ventilation systems and components. Measuring pressure at air filters is especially important for preventing damage to fans and saving energy, since some modern ventilation systems are designed to increase power and maintain the same level of air flow when filters become clogged.

Each of these tasks are easy to carry out with premium, portable, measurement instruments. Sauermann instruments are quick and easy to use while catering to every professional requirement, saving engineers and technicians precious time and allowing them to focus on their core areas of expertise.

“Measuring pressure at air filters is especially important for preventing damage to fans and saving energy.”





Multifunction

Commissioning and maintaining ventilation systems involves measuring a wide range of air parameters, from temperature, pressure, and air flow and velocity, to humidity, CO₂ concentration and more. That's why portable, multifunction instruments are the tool of choice for these tasks.

Sauermann has extensive expertise in manufacturing premium measurement instruments. Our devices deliver the high degree of accuracy needed to test ventilation systems against the indoor air quality standards and recommendations that apply to residential, commercial, and industrial buildings.

Sauermann's portable, multifunction devices are some of the most advanced commissioning, testing, balancing and maintenance instruments on the market. And because they're built for reliability, speed and user-friendliness, they help professionals work more efficiently. What's more, their modular design and range of attachable probes lets engineers build a custom measurement solution – all calibrated in Sauermann's in-house laboratories, which are accredited by COFRAC to ISO 17025:2017.

“Our devices deliver the high degree of accuracy needed to test ventilation systems against indoor air quality standards and recommendations.”

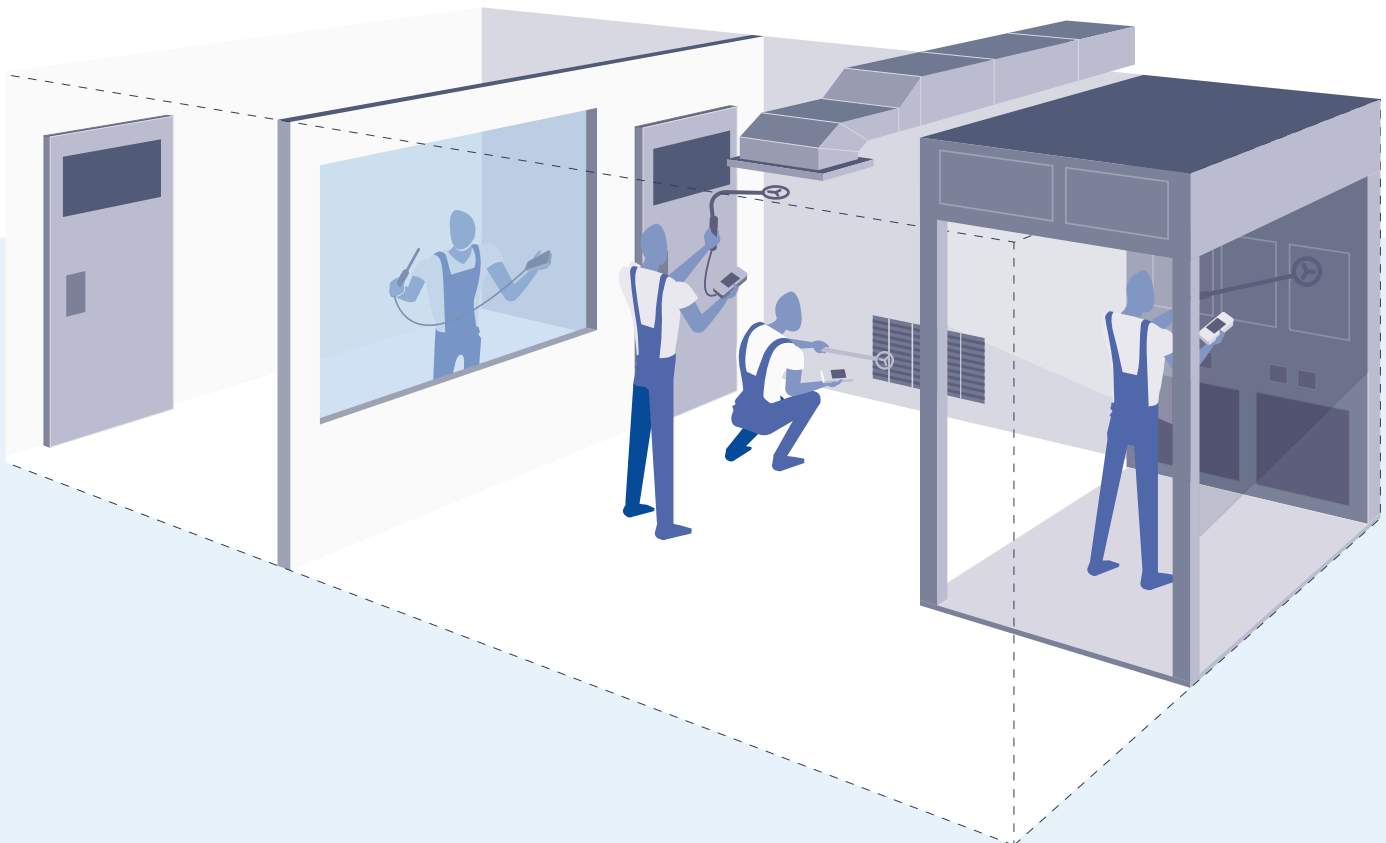



Modules and probes

HQ 210

VT 210

MP 210

AMI 310

Humidity
Temperature
CO₂ / CO

Air velocity
Humidity
Tachometry

Pressure
Air velocity
Tachometry
CO

Multifunction
All parameters



500 Pa Pressure Module
MPR 500

-

-

✓

✓

2500 Pa Pressure Module
MPR 2500

-

-

✓

✓

10,000 Pa Pressure Module
MPR 10000

-

-

✓

✓



SCOH 112

✓

-

-

✓



Tachometry probe
STA

-

✓

✓

✓



Type L Pitot tubes

✓

-

✓

✓



SFC 300

-

✓

✓

✓



SFC 900

-

✓

✓

✓

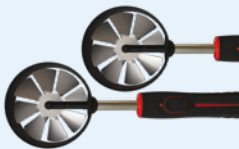

SH 100

-

✓

✓

✓

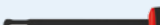

SHF 100

-

✓

✓

✓

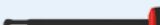

SHR 110

✓

✓

-

✓



SIPS 150

✓

✓

✓

✓



SPK 150

✓

✓

✓

✓

Multifunction

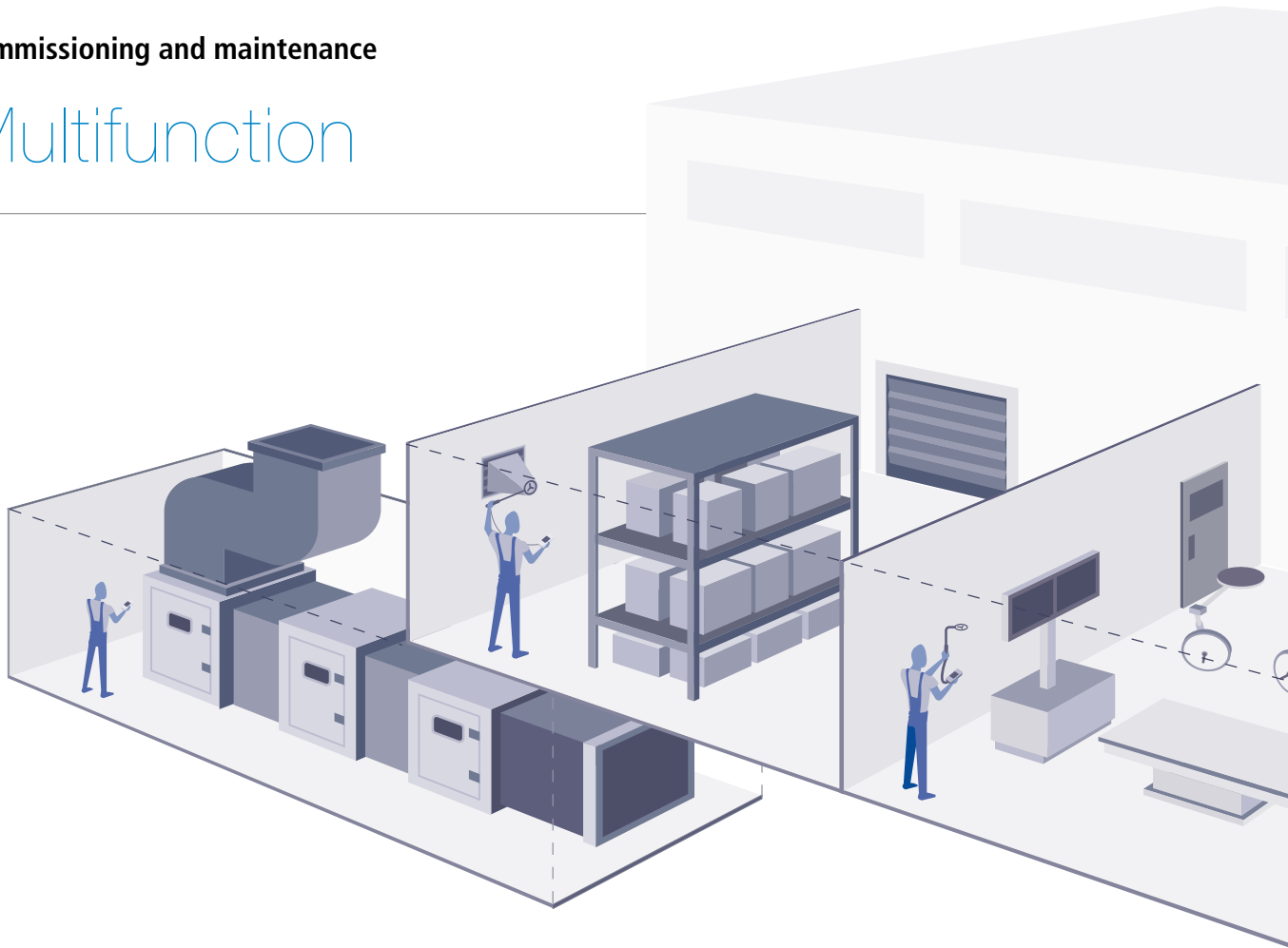

Measures all key parameters in ventilation-system pipes, vents and filters in any type of public building.

Solution
AMI 310



Measures differential pressure across filters in ventilation-system pipes close to the air treatment unit.

Solution
MP 210



Measures the angular velocity of a fan in an air treatment unit.

Solution
STA probe with MP 210, VT 210 or AMI 310

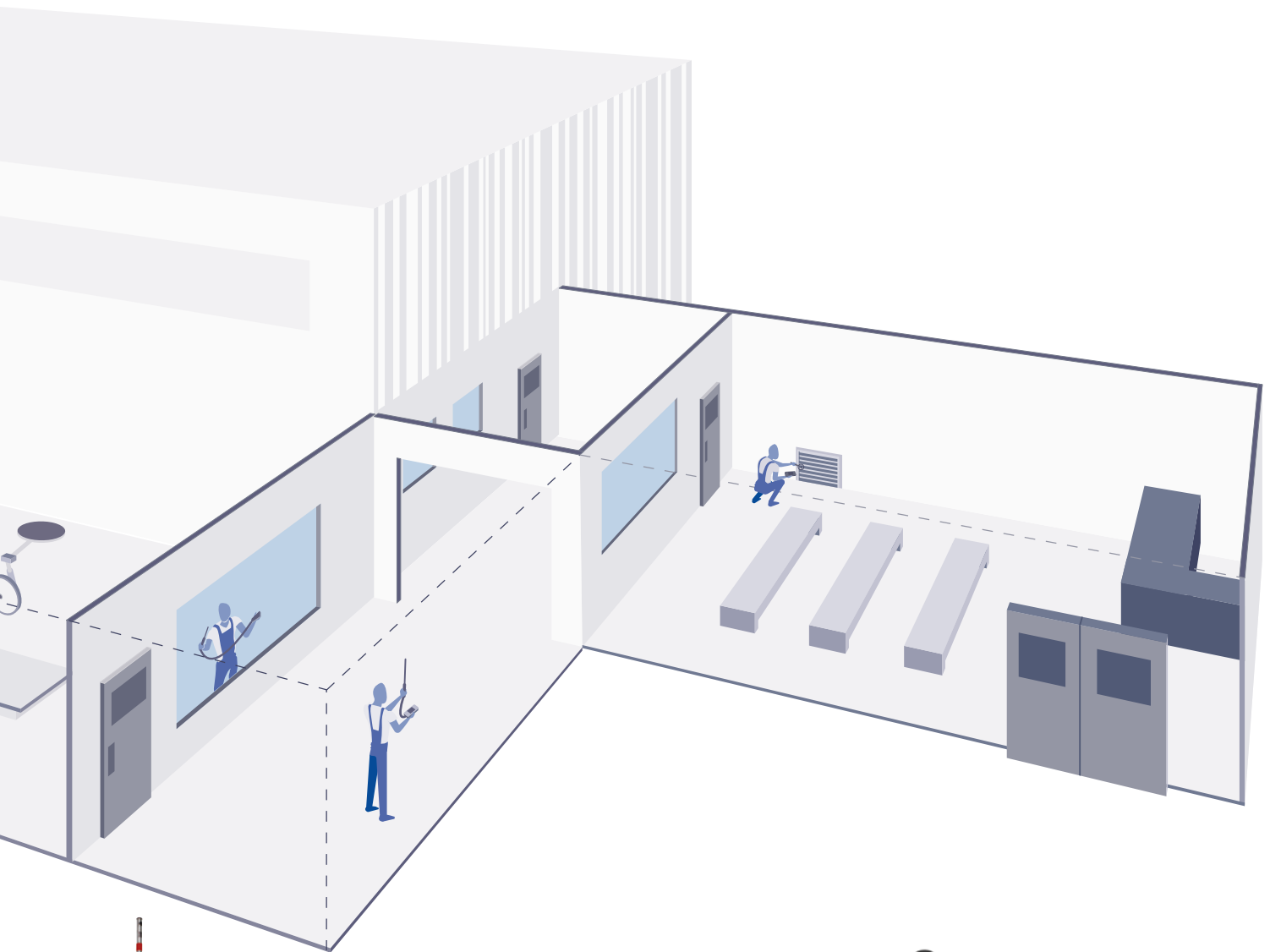

Measures air flow and velocity inside ventilation-system pipes and vents.

Solution

Hot wire or vane probe with air flow cone and VT 210, MP 210 or AMI 310

Pitot tube with MP 210 or AMI 310



Measures the temperature, humidity and psychrometric parameters of ambient air and blown air inside ventilation-system pipes and vents.

Solution

HQ 210 with temperature and humidity probe



Measures air quality parameters for ambient air and inside ventilation-system pipes in any type of public building.

Solution

SCO-H-112 probe with HQ 210 or AMI 310

Air velocity and airflow

At Sauermann, we have long recognised that air flow is a critical measurement for maintaining indoor air quality in commercial and public buildings – and that the air change rate (ACR), its associated parameter, is of crucial importance. That’s why we designed the DBM 620 air flow meter specifically for this purpose: to easily calculate the ACR via the accompanying mobile app.

Air flow readings play a key role in checking whether the ACR is high enough – and in keeping the system running as efficiently as possible.

“An air flow meter is the most versatile and effective portable instrument for measuring vent air flow.”

Regularly replacing the air in a room – by bringing in a flow of filtered air from outside – is the most effective way to reduce concentrations of pollutants such as volatile organic compounds (VOCs), bacteria, viruses and dust. Measuring the ACR is therefore especially important in ensuring that the air inside a confined space is clean and healthy.

An air flow meter is the most versatile and effective portable instrument for measuring air flow. It is compatible with all types of air vent – incoming and outgoing – and far outperforms other solutions when it comes to measurement accuracy.

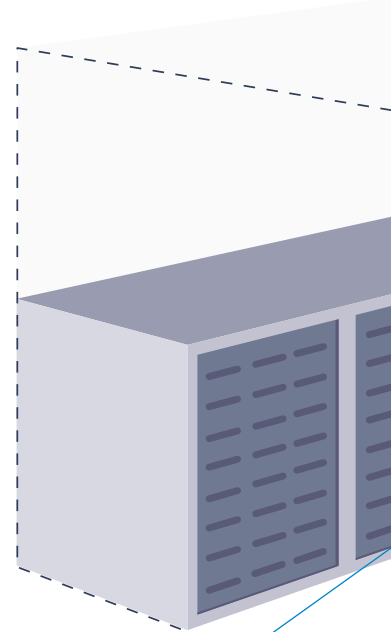

Measures air flow, temperature and humidity on any type of air vent in shopping centres, data centres, hospitals and any other type of public building.

Solution
DBM 620

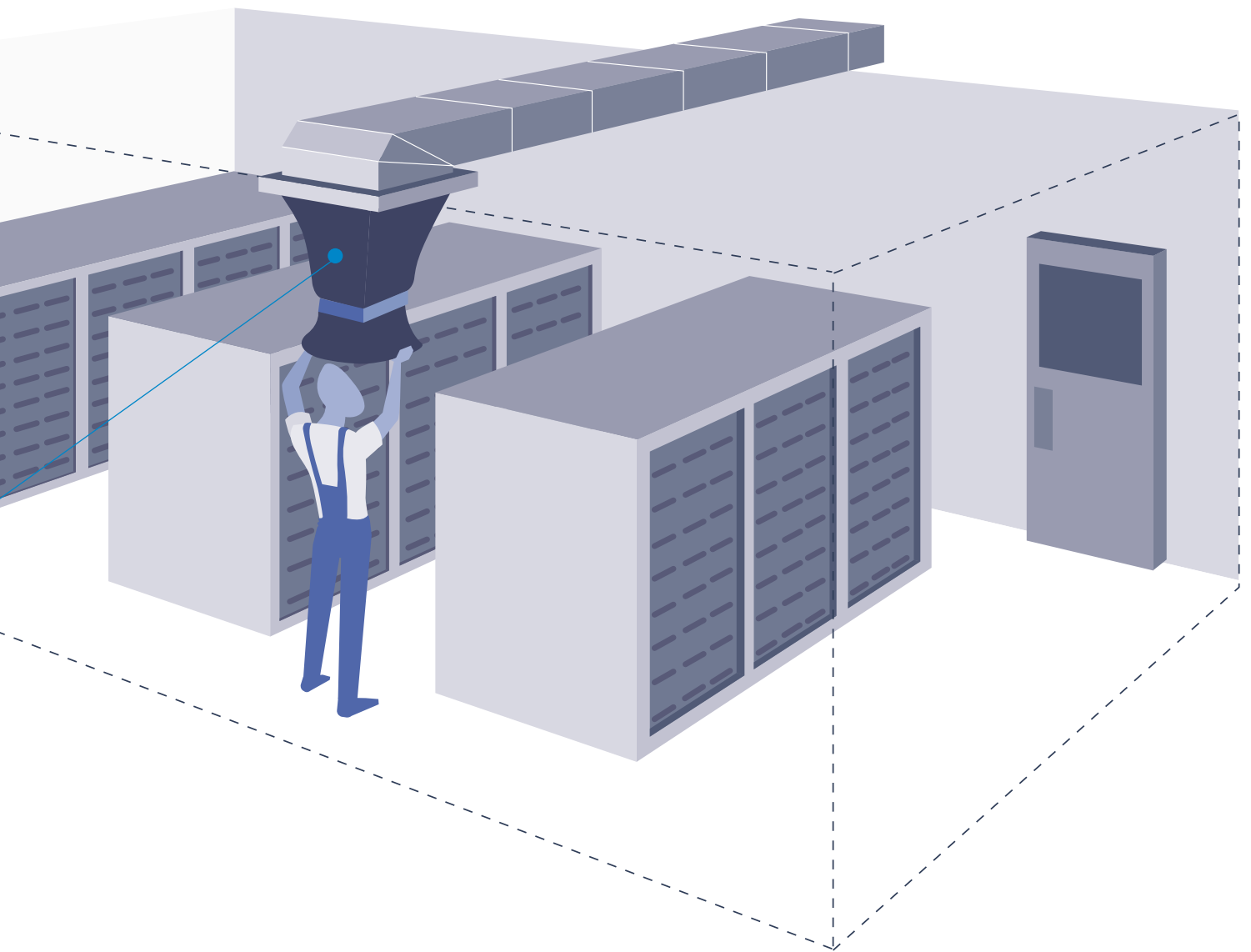

An all-in-one measurement powerhouse		
Differential pressure	Temperature	Humidity
Air velocity	Air flow	Air Change Rate (calculated)

Differential pressure

Measuring differential pressure on either side of an air filter is an extremely common maintenance procedure – and also one of the most important. Regularly replacing clogged filters helps to improve air quality and air flow while reducing energy use, because a new filter reduces pressure drop compared with a clogged one and doesn't contaminate the air that passes through it.

“An extremely common maintenance procedure – and also one of the most important.”



Measure differential pressure at air filters.

Solution
MP 110 or MP 115

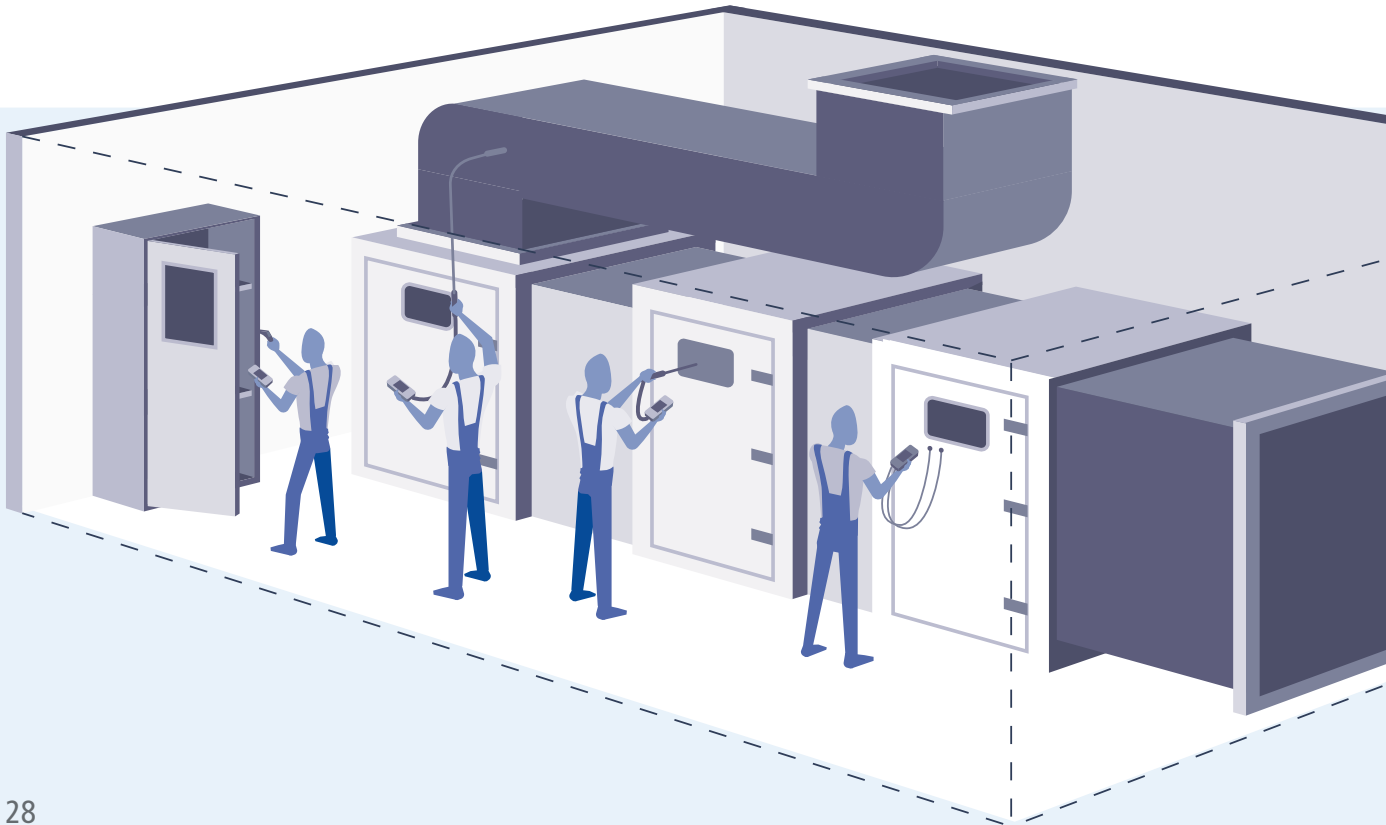

Commissioning, validation and maintenance

Temperature and humidity

Temperature and humidity are two of the fundamental parameters involved in indoor air quality management. They influence many other aspects of the ventilation chain, not least the heating and air conditioning settings.

These two properties also have major implications for occupant health in commercial buildings, as well as affecting the lifespan of certain materials, which can be damaged by the growth of mould. That's why it's essential to measure temperature and humidity both inside the ventilation-system pipes and in the ambient air in occupied areas of a building.

"Temperature and humidity need to be tightly controlled in certain types of commercial premises, such as data centres."

Temperature and humidity need to be tightly controlled in certain types of commercial premises, such as data centres, as well as in main distribution frames, transformer rooms and other technical facilities.



Measures temperature in the ambient air, in pipes and at air filters.

Solution

TK 61 or TK 62 with thermocouple probes



Measures temperature and humidity in the ambient air, in pipes and at air vents.

Solution

HD 110



Measures temperature in an electrical panel in a building's plant room, transformer room or power supply room.

Solution

Kiray 100

Air flow and velocity

Our portable instruments, coupled with cones of different sizes, are ideal for inspection and maintenance tasks, providing quick and reliable air flow measurements at vents. Our thermo-anemometers are the perfect tool for this task, since they also provide air temperature readings that give a clearer picture of ventilation system performance.

“Improved indoor air quality management and ventilation system efficiency gains.”

Measuring air flow is vital to effective indoor air quality management, since every aspect of the environmental conditions inside a building hinge on this parameter. Getting the air flow just right leads to improved indoor air quality management and ventilation system efficiency gains. It's equally important to measure the air flow through outlet vents, in order to check that the air inside a room – which is loaded with CO₂, particles, chemical and biological compounds, and other pollutants – is being extracted effectively.

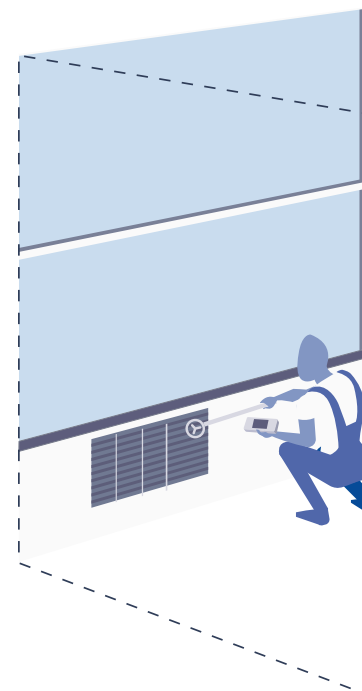

Measures air flow and velocity in ventilation-system pipes.

Solution
VT 110



Measures air flow and velocity at air vents (except diffusers).

Solution
LV 110



Measures air flow and velocity at air vents, diffusers and extractor fan vents.

Solution
LV 110 with Si-K25 and Si-K85 cones
VT 110 with K35 and K75 cones

Commissioning, validation and maintenance

CO₂

Carbon dioxide (CO₂) concentration is a vital measurement in assessing indoor air quality. In fact, it's a key indicator of the rate at which air is replenished in a room – the air change rate, or ACR – for several reasons: because CO₂ concentration is highly responsive to changes in indoor atmospheric conditions, because it's directly influenced by the number of people in a room (each of whom breathes out CO₂), and because it's quick and easy to measure.

"Sauer mann instruments use non-dispersive infrared (NDIR) CO₂ sensors, the only kind of sensor that delivers dependable CO₂ concentration readings."

But reliable measurements can only be obtained using premium, calibrated devices. That's why Sauer mann instruments use non-dispersive infrared (NDIR) CO₂ sensors, the only kind of sensor that delivers dependable CO₂ concentration readings.

Our AQ 110 portable instrument is configured in the lab and certified to CO₂ measurement regulations. As well as taking occasional readings, its internal memory can store recurring measurements, providing insights into changes in CO₂ concentration as the number of occupants in a room fluctuates over the course of a day. These measurement campaigns allow the air flow from the ventilation system to be adjusted in line with target ACR values.



Measures the quality of ambient indoor air (CO₂ concentration and temperature).

Solution
AQ 110

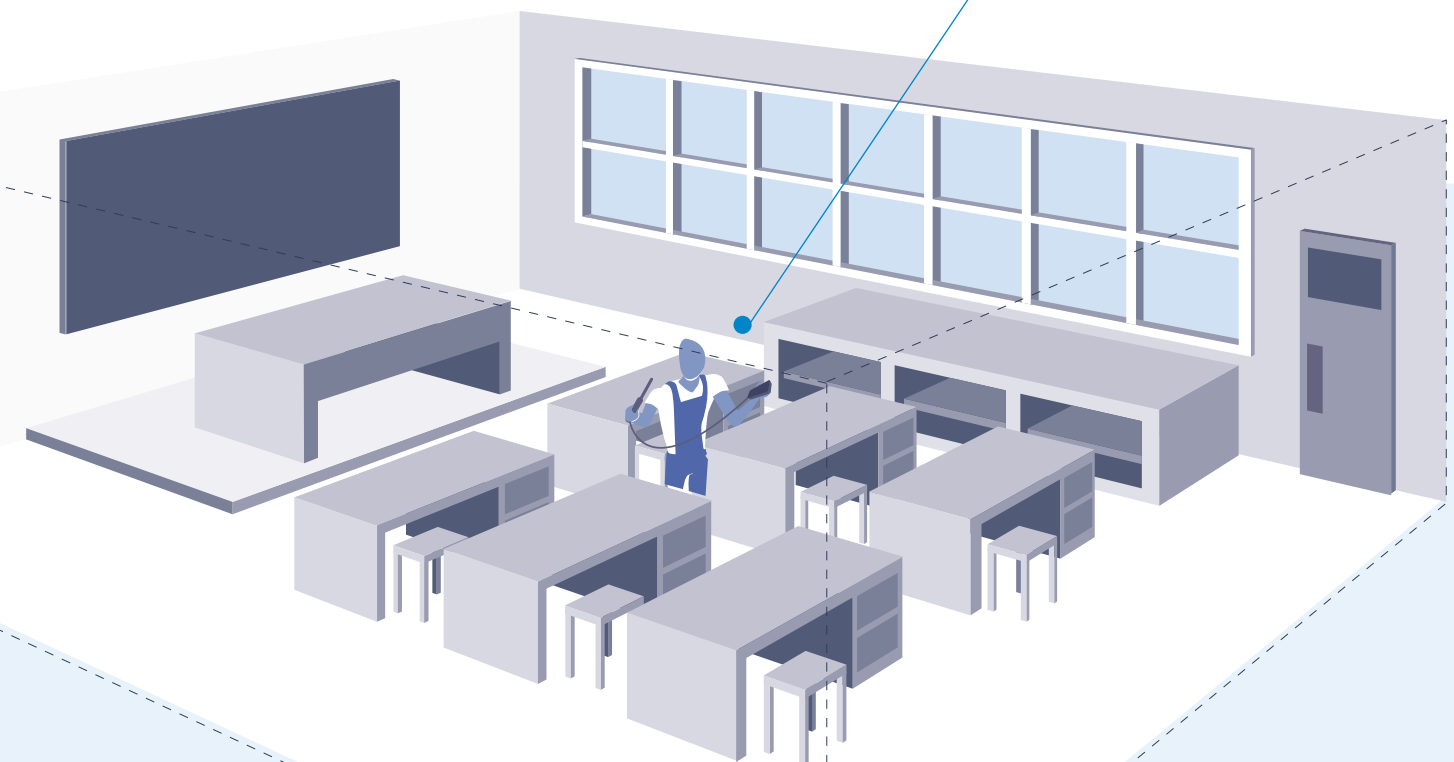

Commissioning, validation and maintenance

Tachometry

Tachometers provide a precise measurement of the actual speed at which a fan inside an air treatment unit is rotating. Because these mechanical parts can wear over time, checking their performance at regular intervals can help in preventing breakdowns and costly downtime – or worse, damage to equipment in data centres and other critical facilities.

“Preventing breakdowns and costly downtime – or worse, damage to equipment in data centres and other critical facilities.”

Our CT 110 tachometer is an easy and reliable way to take these readings, with a conveniently designed remote probe that works via an optical or contact connection – all backed by a calibration certificate.

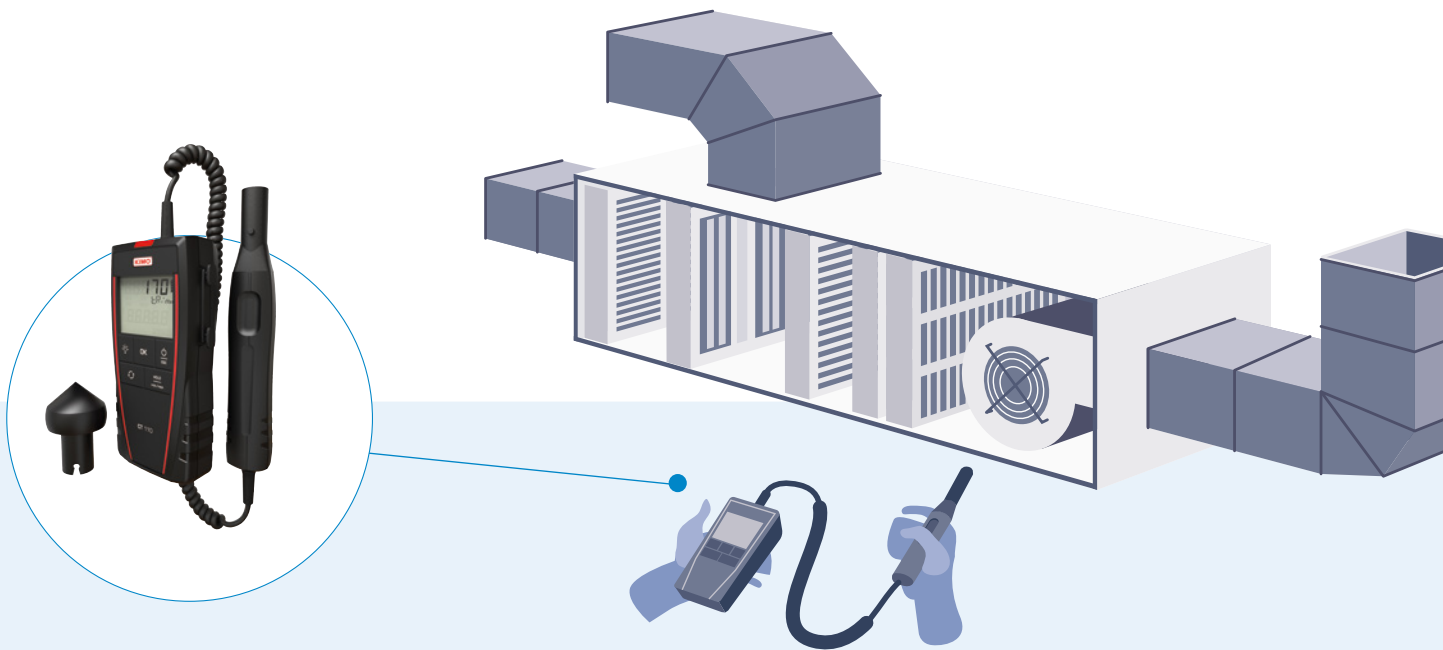

Measures the angular velocity of a fan in an air treatment unit.







Solution

CT 110

Transmitters

Our most common articles for ventilation and air conditioning applications

Multifunction

PRODUCT	ITEM	REF.	MEASURED PARAMETERS						DESCRIPTION
			Pa	°C/°F	%RH	m/s	m ³ /h	ppm	
	Si-C320-D	27940	✓	✓	✓	✓	✓	✓	<p>Si-C320-D Multifunction transmitter with 4 analogue outputs (0-5 V / 0-10 V or 0-20 mA / 4-20 mA), 4-wire technology.</p> <ul style="list-style-type: none"> • 24 V_{AC} / V_{DC} power supply. With touch screen display. • 2 inputs for Smart probes, and one location for Si-PRO-DP module. • IP66 ABS V0 housing VHP resistant. • Supplied with adjustment certificate. • Optional: all interchangeable probes and all compatible Si-PRO-DP modules, calculation of the air velocity and airflow (SQR-3). Wireless communication module, 4-relay module and calibration certificate.
	Si-C320-D-1000	27946	✓	✓	✓	✓	✓	✓	<p>Si-C320-D-1000 Multifunction transmitter with interchangeable differential pressure module, with solenoid valve and K thermocouple connector</p> <ul style="list-style-type: none"> • Range: -1000 to +1000 Pa. • Supplied with pressure connectors, silicone tube and adjustment certificate. With 4 analogue outputs (0-5 V / 0-10 V or 0-20 mA / 4-20 mA), 4-wire technology. • 24 V_{AC} / V_{DC} power supply. With touch screen display. 2 inputs for Smart probes. IP66 ABS V0 housing VHP resistant. • Supplied with adjustment certificate. • Optional: all interchangeable probes, calculation of the air velocity and air flow (SQR-3). Wireless communication module, 4-relay module and calibration certificate.
	CP 211-BO-R	25631	✓	✓	-	✓	✓	-	<p>CP211-BO-R Differential pressure transmitter</p> <ul style="list-style-type: none"> • ABS V0 IP65 housing. 24 V_{AC} / V_{DC} power supply with galvanic isolation. • 19-digit 2-line display with backlight and trend indicator. • Configuration via keypad. • Measuring range: -100 to 100 Pa with solenoid valve and -100 to 400 °C. • Terminal block for Pt100 remote probe. 2 analogue outputs, 4-wires 0-1/5/10 V or 0/4-20 mA, 2 relays. • Optional: LCC-S configuration software and SQR3 air velocity and airflow calculation function.
	CP 212-BO-R	25636	✓	✓	-	✓	✓	-	<p>CP212-BO-R Differential pressure transmitter</p> <ul style="list-style-type: none"> • ABS V0 IP65 housing. 24 V_{AC} / V_{DC} power supply with galvanic isolation. • 19-digit 2-line display with backlight and trend indicator. • Configuration via keypad. Measuring range -1000 to 1000 Pa with solenoid valve and -100 to 400 °C. • Terminal block for Pt100 remote probe. • 2 analogue outputs, 4-wire technology 0-1/5/10 V or 0/4-20 mA, 2 relays • Optional: LCC-S configuration software and SQR3 air velocity and airflow calculation function.
	CP 212-BN-R	25635	✓	✓	-	✓	✓	-	<p>CP212-BN-R Differential pressure transmitter</p> <ul style="list-style-type: none"> • ABS V0 IP65 housing. 24 V_{AC} / V_{DC} power supply with galvanic isolation. • Without display. • Measuring range: -1000 to 1000 Pa with solenoid valve and -100 to 400 °C. • Terminal block for Pt100 remote probe. • 2 analogue outputs, 4-wires technology 0-1/5/10 V or 0/4-20 mA, 2 relays. • Optional: LCC-S configuration software and SQR3 air velocity and airflow calculation function.
	CP 213-BO-R	25640	✓	✓	-	✓	✓	-	<p>CP213-BO-R Differential pressure transmitter</p> <ul style="list-style-type: none"> • ABS V0 IP65 housing. 24 V_{AC} / V_{DC} power supply with galvanic isolation. • 19-digit 2-line display with backlight and trend indicator. • Configuration via keypad. • Measuring range: -10,000 to 10,000 Pa and -100 to 400 °C. • Terminal block for Pt100 remote probe. • 2 analogue outputs, 4-wire technology 0-1/5/10 V or 0/4-20 mA, 2 relays. • Optional: LCC-S configuration software and SQR3 air velocity and airflow calculation function.

PRODUCT	ITEM	REF.	MEASURED PARAMETERS						DESCRIPTION
			Pa	°C/°F	%RH	m/s	m³/h	ppm	
	TH 110-POS	23954	-	✓	✓	-	-	-	TH110-POS Relative humidity and temperature transmitter <ul style="list-style-type: none"> Ambient ABS V0 IP20 housing with easy-mounting system. 10-digit display. Measuring range from 5 to 95 %RH and 0 to 50 °C, 4-20 mA output and 16 to 30 V_{DC} power supply (passive 2-wire). Optional: LCC-S configuration software.
	TH 110-POD	23952	-	✓	✓	-	-	-	TH110-POD Relative humidity and temperature transmitter <ul style="list-style-type: none"> ABS V0 IP65 housing with easy-mounting system. 10-digit display, ABS remote probe length 150 mm and 2 m cable. Measuring range from 5 to 95 %RH and -20 to 80 °C, 4-20 mA output and 16 to 30 V_{DC} power supply (passive 2-wire). Optional: LCC-S configuration software.
	TH 110-PNA	23956	-	✓	✓	-	-	-	TH110-PNA Relative humidity and temperature transmitter <ul style="list-style-type: none"> ABS V0 IP65 housing with easy-mounting system. Without display. ABS duct mounting probe length 112 mm. Measuring range 5 to 95 %RH and -20 to 80 °C. 4-20 mA output and 16 to 30 V_{DC} power supply (passive 2-wire). Optional: LCC-S configuration software.
	TH 210 BODI150-R-05M	26497	-	✓	✓	-	-	-	TH210-BODI150-R-05M Humidity and temperature transmitter <ul style="list-style-type: none"> ABS V0 IP65 housing, with 20-digits display, remote probe made of stainless steel with 150 mm stainless steel filter and 5 m cable. Measuring range from 5 to 95 %RH and -40 to 180 °C. 2 x analogue outputs 4-wire technology 0-5/10 V or 0/4-20 mA, 2 relays and 24 V_{DC} / V_{AC} power supply with galvanic isolation. Optional: LCC-S configuration software.
	TH 210-BOSP-R	25648	-	✓	✓	-	-	-	TH210-BOSP-R Temperature and hygrometry transmitter <ul style="list-style-type: none"> ABS V0 IP65 housing, with 19-digit 2-line display, with backlight and trend indicator. 100 mm length ambient probe made of polycarbonate with stainless steel filter. Measuring range from 5 to 95 %RH and -20 to 80 °C. 2 analogue outputs 4-wire technology 0-1/5/10 V or 0/4-20 mA, 2 relays and 24 V_{DC} / V_{AC} power supply with galvanic isolation. Optional: LCC-S configuration software.
	TM 110-POB	23936	-	✓	-	-	-	-	TM110-POB Temperature transmitter <ul style="list-style-type: none"> ABS V0 IP65 housing with easy-mounting system, 10-digit display and Pt100 terminal block input. Measuring range from -100 to 400 °C and 4-20 mA output, with 16 to 30 V_{DC} power supply (passive 2-wire). Optional: LCC-S configuration software.
	TM 110-PNB	23940	-	✓	-	-	-	-	TM110-PNB Temperature transmitter <ul style="list-style-type: none"> ABS V0 IP65 housing with easy-mounting system, without display and with Pt100 terminal block input. Measuring range from -100 to 400 °C and 4-20 mA output with 16 to 30 V_{DC} power supply (passive 2-wire). Optional: LCC-S configuration software.

Customised Products











If you are looking for a product (instrument, probe, accessory) not included in this list, please contact us. We can supply a wide range of specific products on request (delivery times may be longer).

Transmitters and manometers

Our most common articles for ventilation and air conditioning applications







Pressure

PRODUCT	ITEM	REF.	MEASURED PARAMETERS						DESCRIPTION
			Pa	°C/°F	%RH	m/s	m ³ /h	ppm	
	PST 12	24009	✓	-	-	-	-	-	PST-12 Differential manostat <ul style="list-style-type: none"> ABS V0 IP65 housing with easy-mounting system, and 10-digit display. Measuring range: -1000 to +1000 Pa, 1 x 3 A / 230 V_{AC} RCR relay output Relay configuration via push-button. 24 V_{DC} / V_{AC} power supply. Optional: LCC-S configuration software.
	PST 13	24010	✓	-	-	-	-	-	PST-13 Differential manostat <ul style="list-style-type: none"> ABS V0 IP65 housing with easy-mounting system, and 10-digit display. Measuring range: -10,000 to +10,000 Pa, 1 x 3 A / 230 V_{AC} RCR relay output. Relay configuration via push-button. 24 V_{DC} / V_{AC} power supply. Optional: LCC-S configuration software.
	CP 111-AN	23903	✓	-	-	-	-	-	CP111-AN Differential pressure transmitter <ul style="list-style-type: none"> ABS V0 IP65 housing with easy-mounting system. Without display. Measuring range: -100 to 100 Pa with solenoid valve. 4-20 mA or 0-10 V output. 24 V_{DC} or 24 V_{AC} power supply. Optional: LCC-S configuration software.
	CP 111-AO	23902	✓	-	-	-	-	-	CP111-AO Differential pressure transmitter <ul style="list-style-type: none"> ABS V0 IP65 housing with easy-mounting system. 10-digit display. Configurable range: -100 to 100 Pa with solenoid valve. 4-20 mA or 0-10 V output. 24 V_{DC} or 24 V_{AC} power supply. Optional: LCC-S configuration software.
	CP 112-PN	23905	✓	-	-	-	-	-	CP112-PN Differential pressure transmitter <ul style="list-style-type: none"> ABS V0 IP65 housing with easy-mounting system. Without display. Measuring range: -1000 to 1000 Pa. 4-20 mA output with 16 to 30 V_{DC} power supply (passive 2-wire). Optional: LCC-S configuration software.
	CP 112-AO	23906	✓	-	-	-	-	-	CP112-AO Differential pressure transmitter <ul style="list-style-type: none"> ABS V0 IP65 housing with easy-mounting system. 10-digit display. Measuring range: -1000 to 1000 Pa. 4-20 mA or 0-10 V output. 24 V_{DC} or 24 V_{AC} power supply. Optional: LCC-S configuration software.
	CP 112-AN	23907	✓	-	-	-	-	-	CP112-AN Differential pressure transmitter <ul style="list-style-type: none"> ABS V0 IP65 housing with easy-mounting system. Without display. Measuring range: -1000 to 1000 Pa. 4-20 mA or 0-10 V output. 24 V_{DC} or 24 V_{AC} power supply. Optional: LCC-S configuration software.
	CP 112-PO	23904	✓	-	-	-	-	-	CP112-PO Differential pressure transmitter <ul style="list-style-type: none"> ABS V0 IP65 housing with easy-mounting system. 10-digit display. Measuring range: -1000 to 1000 Pa. 4-20 mA output with 16 to 30 V_{DC} power supply (passive 2-wire). Optional: LCC-S configuration software.
	CP 113-PO	23908	✓	-	-	-	-	-	CP113-PO Differential pressure transmitter <ul style="list-style-type: none"> ABS V0 IP65 housing with easy-mounting system. 10-digit display. Measuring range: -10,000 to 10,000 Pa. 4-20 mA output with 16 to 30 V_{DC} power supply (passive 2-wire). Optional: LCC-S configuration software.

Transmitters and manometers

Our most common articles for ventilation and air conditioning applications

Pressure

PRODUCT	ITEM	REF.	MEASURED PARAMETERS							DESCRIPTION
			Pa	°C/°F	%RH	m/s	m³/h	ppm		
	CP 113-PN	23909	✓	-	-	-	-	-	CP113-PN Differential pressure transmitter <ul style="list-style-type: none"> • ABS V0 IP65 housing with easy-mounting system. • Without display. • Measuring range: -10,000 to 10,000 Pa. • 4-20 mA output with 16 to 30 V_{DC} power supply (passive 2-wire). • Optional: LCC-S configuration software. 	
	CP 113-AO	23910	✓	-	-	-	-	-	CP113-AO Differential pressure transmitter <ul style="list-style-type: none"> • ABS V0 IP65 housing with easy-mounting system. • 10-digit display. • Measuring range: -10,000 to 10,000 Pa. • 4-20 mA or 0-10 V output. 24 V_{DC} or 24 V_{AC} power supply. • Optional: LCC-S configuration software. 	
	CP 113-AN	23911	✓	-	-	-	-	-	CP113-AN Differential pressure transmitter <ul style="list-style-type: none"> • ABS V0 IP65 housing with easy-mounting system. • Without display. • Measuring range: -10,000 to 10,000 Pa. • 4-20 mA or 0-10 V output. 24 V_{DC} or 24 V_{AC} power supply. • Optional: LCC-S configuration software. 	
	MG 50 E6	25397	✓	-	-	-	-	-	MG50 E6 Inclined liquid column manometer <ul style="list-style-type: none"> • Range: 0-500 Pa. • Supplied with two 487 connectors, AWS10 liquid and a wall-mounting plate. 	
	MG 80 E6	25398	✓	-	-	-	-	-	MG80 E6 Inclined liquid column manometer <ul style="list-style-type: none"> • Range: 0-800 Pa. • Supplied with two 487 connectors, AWS10 liquid and a wall-mounting plate. 	
	TJ 300 AWS10 E6	10124	✓	-	-	-	-	-	TJ300 AWS10 E6 Vertical liquid column manometer <ul style="list-style-type: none"> • Range: 0-300 mmH₂O. Supplied with two 487 connectors. • Liquid AWS10 and a wall-mounting plate. 	
	CP 25 E2	10443	✓	-	-	-	-	-	CP25 E2 Inclined liquid column manometer <ul style="list-style-type: none"> • Range: 0-25 mmH₂O. • Supplied with two 487 connectors, AWS10 liquid and without wall-mounting plate. • Color zones: 0-5 mmH₂O White / 5-10 mmH₂O Green / 10-15 mmH₂O Yellow / 15-25 mmH₂O Red. 	



Customised Products







If you are looking for a product (instrument, probe, accessory) not included in this list, please contact us. We can supply a wide range of specific products on request (delivery times may be longer).

















Transmitters and manometers

Our most common articles for ventilation and air conditioning applications

	PRODUCT	ITEM	REF.	MEASURED PARAMETERS							DESCRIPTION
				Pa	°C/°F	%RH	m/s	m³/h	ppm		
Air velocity and flow rate		CTV 110-AOD300	23921	-	✓	-	✓	-	-	CTV110-AOD300 Temperature and air velocity transmitter <ul style="list-style-type: none"> • ABS V0 IP65 housing with easy-mounting system, 10-digit display, and remote hotwire probe made of polycarbonate length 300 mm and 2 m cable. • Measuring range: from 0 to 30 m/s and 0 to 50 °C. • 2 x 4-20 mA outputs (active 3-4 wire) and 24 V_{DC} or 24 V_{AC} power supply. • Optional: LCC-S configuration software. 	
		CTV 110-ANA300	23927	-	✓	-	✓	-	-	CTV110-ANA300 Temperature and air velocity transmitter <ul style="list-style-type: none"> • ABS V0 IP65 housing with easy-mounting system, without display. • Duct mounting 300 mm hotwire probe made of polycarbonate. • Measuring range: from 0 to 30 m/s and 0 to 50 °C. • 2 x 4-20 mA outputs (active 3-4 wire) and 24 V_{DC} or 24 V_{AC} power supply. • Optional: LCC-S configuration software. 	
CO ₂		CO 112-ANA	23998	-	-	-	-	-	✓	CO112-ANA CO ₂ transmitter <ul style="list-style-type: none"> • ABS V0 IP65 housing with easy-mounting system. Without display. • Measuring range: from 0 to 5000 ppm. • Duct mounting probe. • 4-20 mA or 0-10 V output. 24 V_{DC} or 24 V_{AC} power supply. • Optional: LCC-S configuration software. 	

Accessories



	ACCESSORIES	ITEM	REF.	MEASURED PARAMETERS							DESCRIPTION
				Pa	°C/°F	%RH	m/s	m³/h	ppm		
		Si-PRO-U-I-150	27984	-	✓	✓	-	-	-	Si-PRO-U-I-150 Interchangeable hygrometry probe. Stainless steel body with stainless steel filter. For Si-C320 and Si-CPE320 <ul style="list-style-type: none"> • 150 mm length remote probe, Ø 13 mm. • Measuring range: 0 to 100 %RH and -40 to +150 °C, autolock connector. • Supplied with adjustment certificate. • Optional: protection tip and filters. 	
		Si-PRO-V-300	27989	-	✓	-	✓	✓	-	Si-PRO-V-300 Interchangeable hotwire probe for air velocity and temperature measurements. Stainless steel body length 267 mm, Ø 8 mm. <ul style="list-style-type: none"> • Measuring range: 0 to 30 m/s and 0 to 50 °C, autolock connector. • Supplied with adjustment certificate. 	
		Si-ACC-R2	27999	-	-	-	-	-	-	Si-ACC-R2 Connection cable for Si-PRO-U-I-150 temperature/humidity probe.	
		Si-ACC-RVP	28002	-	-	-	-	-	-	Si-ACC-RVP Connection cable for Si-PRO-V-300 air velocity probe.	

ACCESSORIES	ITEM	REF	MEASURED PARAMETERS							DESCRIPTION
			Pa	°C/°F	%RH	m/s	m ³ /h	ppm		
	Si-ACC-R5	28000	-	-	-	-	-	-	Si-ACC-R5 5 m extension for class 320 interchangeable probes.	
	SF 50-PS-02-6-100	25997	-	✓	-	-	-	-	SF50-PS-02-6-100 Pt100 class A temperature probe (3 wires) <ul style="list-style-type: none"> • Probe Ø 6 mm - 100 mm length. • PVC cable - 2 m length. • Operating temperature: -40 to +105 °C. 	
	SF 50-TS-05-6-100	26051	-	✓	-	-	-	-	SF50-TS-05-6-100 Pt100 class A temperature probe (3 wires) <ul style="list-style-type: none"> • Probe Ø 6 mm - 100 mm length. • PTFE cable - 5 m length. • Operating temperature: -50 to +260 °C. 	
	BFP 13	18401	-	-	-	-	-	-	BFP-13 Mounting bracket made of PETP, for temperature probes Ø 13 mm. Supplied with screws and fixing pins.	
	LCC-S	24106	-	-	-	-	-	-	LCC-S Configuration software <ul style="list-style-type: none"> • For monostat, class 110 / 210 and 310 transmitters. • Supplied with USB cable and user manual. 	
	SQR/3	24105	-	-	-	✓	✓	-	Factory activation of the SQR/3 square root extraction function for the the air velocity and air flow calculation, from the differential pressure measurement. <ul style="list-style-type: none"> • For CP 210-R transmitters. • Function activated by default in class 320 transmitters with differential pressure modules (Si-PRO-DP). • Activation carried out only in factory on new instruments (should be ordered together with the CP 210-R), or by the user after buying the instrument (please contact your sales representative for further details). 	
	C-58-25	10321	-	-	-	-	-	-	C-58-25 Clear tube, Ø 5 x 8 mm, 25 m roll.	
	DP 447	10388	-	-	-	-	-	-	DP447 Connection for double-shell wall, max. thickness 30 mm.	
	DP 339	11090	-	-	-	-	-	-	DP339 Connection for double-shell wall, max. thickness 80 mm.	
	PC 482 L. 70	10393	-	-	-	-	-	-	PC482 L.70 Bulkhead through-connection with adjustable knurled nut for bulkhead from 47 to 70 mm thick.	
	PC 482 L. 90	10395	-	-	-	-	-	-	PC482 L.90 Bulkhead through-connection with adjustable knurled nut for bulkhead from 67 to 90 mm thick.	
	PC482 L.110	10227	-	-	-	-	-	-	PC482 L.110 Bulkhead through-connection <ul style="list-style-type: none"> • for bulkhead from 87 to 110 mm thick. 	
	JTC x 10	11922	-	-	-	-	-	-	J.T.C. 10 units bag of T-connection. For Ø 5 x 8 mm tube.	
	RACC 483	10222	-	-	-	-	-	-	483 connection Ø 1	
	30 ML AWS10 RED	10048	-	-	-	-	-	-	30 ml bottle of liquid AWS.10 red, density = 0.87	
	500 ML AWS10 RED	10051	-	-	-	-	-	-	500 ml bottle of liquid AWS.10 red, density = 0.87	

Data loggers

Our most common articles for ventilation and air conditioning applications











Multifunction

PRODUCT	ITEM	REF.	MEASURED PARAMETERS						DESCRIPTION
			Pa	°C/°F	%RH	m/s	m ³ /h	ppm	
	KCC 320	25253	-	✓	✓	-	-	✓	KCC-320 Temperature/hygrometry/atmospheric pressure/CO ₂ datalogger <ul style="list-style-type: none"> With internal sensor (-20 to +70 °C, 5 to 95 %RH, 800 to 1100 hPa and 0 to 5,000 ppm). 2-line display, IP40 protection housing with magnet fixing and anti-theft wall-mounting support. Wireless communication for mobile and tablets applications (Android and iOS). Memory capacity: 2,000,000 measuring points.
	KT 320	25248	-	✓	✓	-	-	✓	KT-320 Temperature datalogger, with internal sensor (-40 to +70 °C) <ul style="list-style-type: none"> 2-line display, IP65 protection housing with magnet fixing and anti-theft wall-mount support. 2 external inputs for temperature/hygrometry/current/voltage/impulse probe. Wireless communication for mobile and tablets (Android and iOS). Memory capacity: 2,000,000 measuring points.

Temperature and humidity

	KH 50	24912	-	✓	✓	-	-	-	KH-50 Temperature and humidity datalogger <ul style="list-style-type: none"> With internal sensor (-20 to +70 °C and 5 to 95 %RH), with 1-line display. IP20 housing with magnet fixing. Memory capacity 16,000 points.
	KH 120	25231	-	✓	✓	-	-	-	KH-120 Temperature/hygrometry datalogger <ul style="list-style-type: none"> With internal sensor (-20 to +70 °C, 5 to 95 %RH). 1-line display, IP20 protection housing with magnet fixing. Built-in USB connector, integrated function for automatic report printing and for configuration via PDF. Memory capacity: 50,000 measuring points. Compatible with Kilog 2015 dataprocessing software, coming in option).
	KH 220-O	25238	-	✓	✓	-	-	-	KH-220-O Temperature/hygrometry/light datalogger <ul style="list-style-type: none"> With internal sensor (-20 to +70 °C, 5 to 95 %RH, 0 to 10,000 lux). 2-line display, IP40 protection housing with magnet fixing. 1 external input for temperature/hygrometry/current/voltage/impulse and water pressure probe. Memory capacity: 1,000,000 measuring points.
	KT 220-O	25234	-	✓	✓	-	-	-	KT-220-O Temperature datalogger <ul style="list-style-type: none"> with internal sensor (-40 to +70 °C). 2-line display, IP65 protection housing, magnet fixing. 1 external input for temperature/hygrometry/current/voltage/impulse and water pressure probe. Memory capacity: 1,000,000 measuring points.
	KT 50	24911	-	✓	-	-	-	-	KT-50 Temperature datalogger <ul style="list-style-type: none"> With internal sensor (-40 to +70 °C). 1-line display. IP65 housing with magnet fixing. Memory capacity 16,000 points. Compliant with norm NF EN 12830.
	KT 120	25230	-	✓	-	-	-	-	KT-120 Temperature datalogger <ul style="list-style-type: none"> With internal sensor (-40 to +70 °C). 1-line display, IP65 protection housing with magnet fixing. Built-in USB connector. Integrated function for automatic report printing and for configuration via PDF. Memory capacity: 50,000 measuring points. As per 12830 norm. Compatible with Kilog 2015 dataprocessing software, coming in option).
	KTT 220-O	25236	-	✓	-	-	-	-	KTT-220-O Temperature datalogger <ul style="list-style-type: none"> With 2 K thermocouple inputs (-200 to +1300 °C), J (-100 to +750 °C) T (-200 to +400 °C), N (-200 to +1300 °C) and S (0 to +1760 °C). 2-line display, IP54 protection housing, magnet fixing. Memory capacity: 1,000,000 measuring points.

Accessories

ACCESSORIES	ITEM	REF.	MEASURED PARAMETERS							DESCRIPTION
			Pa	°C/°F	%RH	m/s	m³/h	ppm		
	KTHD	25322	-	✓	✓	-	-	-	KTHD Temperature/hygrometry interchangeable probe <ul style="list-style-type: none"> • Remote probe (5 to 95 %RH and -20 to +70 °C). • Probe body made of ABS, 130 mm length, with stainless steel filter. • 2 m length PVC cable. • With mini-DIN connector for class 220 Kistock. 	
	KITHA	25265	-	✓	✓	-	-	-	KITHA Ambient temperature/hygrometry probe <ul style="list-style-type: none"> • Smart probe (5 to 95 %RH and -20 to +70 °C). • Probe body made of ABS, 95 mm length, with connector with stainless steel filter. 	
	KTHA	25247	-	✓	✓	-	-	-	KTHA Ambient temperature/hygrometry probe <ul style="list-style-type: none"> • Interchangeable probe (5 to 95 %RH and -20 to +70 °C). • Probe body made of ABS, 65 mm length. • With mini-DIN connector and stainless steel filter for class 220 Kistock. 	
	KITHP 130	25266	-	✓	✓	-	-	-	KITHP-130 Remote temperature/hygrometry probe <ul style="list-style-type: none"> • Smart probe (5 to 95 %RH and -20 to +70 °C). • Probe body made of ABS, 130 mm length, with stainless steel filter. • 2 m length PVC cable with mini-DIN connector. 	
	KIRV 320	25349	-	✓	-	-	-	-	KIRV-320 Wired Pt100 temperature probe with hook and loop fastener <ul style="list-style-type: none"> • 200 mm length. • Output on 2 m length PVC cable. • With mini-DIN connector (-20 to +90 °C). • For class 320 Kistock. 	
	KSI 150	25291	-	✓	-	-	-	-	KSI-150 NTC Immersion temperature probe <ul style="list-style-type: none"> • 150 mm length stainless steel probe, Ø 6 mm. • Output on 2 m length PVC cable. • With mini-DIN connector (-40 to +120 °C). 	
	KIRGA 50	25257	-	✓	-	-	-	-	KIRGA-50 Pt100 smart immersion probe <ul style="list-style-type: none"> • Class A, IP65 protection. • 50 mm length stainless steel probe, Ø 6 mm. • Output on 2 m length PVC cable. • With mini-DIN connector (-40 to +120 °C) for class 320 Kistock. 	
	KICA 320	27911	-	✓	-	-	-	-	KICA-320 Adapter cable for other Pt100 temperature probes <ul style="list-style-type: none"> • 3-wires, including one connection terminal block and one mini-DIN male connector. • For Kistock KT 320 and KT TrackLog. • To be mounted on already delivered probes (must be ordered alone - without probe). 	
	KIC3-N	25244	-	-	-	-	-	-	KIC3-N Configuration and dataprocessing software (Kilog 2015) <ul style="list-style-type: none"> • Supplied with CK-50 USB cable for Kistock (except KT-20 and class 120). 	
	KBL AA	25240	-	-	-	-	-	-	KBL-AA Battery, AA Lithium 3.6 V <ul style="list-style-type: none"> • For Kistock class 220, 320 (2 batteries required on class 320). 	





Customised Products

If you are looking for a product (instrument, probe, accessory) not included in this list, please contact us. We can supply a wide range of specific products on request (delivery times may be longer).

Portable instruments

Our most common articles for clean rooms and regulated environments

Multifunction



PRODUCT	ITEM	REF	MEASURED PARAMETERS						DESCRIPTION
			Pa	°C/°F	%RH	m/s	m³/h	ppm	
	AMI 310	24752	✓	✓	✓	✓	✓	✓	<p>AMI 310 Multi-function portable instrument with colour backlit graphic display</p> <ul style="list-style-type: none"> With 2 input channels for measuring probes and Pt100 temperature probes (-200 to +600 °C). 2 channels for K/J/T/S thermocouple input (-200 to +1760 °C). Output for PC and printer. Supplied SOLE, with 2 cables with mini-DIN connector for measuring probes (in option). 2 lithium ion rechargeable batteries, with USB / mains adapter cable, micro SD card for data storage, 2 x 1 m of silicone tube Ø 4 x 7 mm, one 100 mm length stainless steel tube Ø 6 mm, adjustment certificate and transport case. Optional: all measuring modules, all measuring probes, all temperature probes (wired or wireless), software and printer.
	AMI 310STD	24754	✓	✓	✓	✓	✓	✓	<p>AMI 310 STD Multi-function portable instrument with colour backlit graphic display</p> <ul style="list-style-type: none"> With 2 input channels for measuring probes and Pt100 (-200 to +600 °C) temperature probes, 2 channels for K/J/T/S thermocouple input (-200 to +1760 °C). Output for PC and printer. Supplied with pressure module (-10,000 + 10,000 Pa, 4 to 100 m/s), hotwire probe (0.15 to 30 m/s). ABS hygrometry probe (3 to 98 %RH and -20 +80 °C). Ø 100 mm vane probe (0.3 to 35 m/s), Pitot tube length 300 mm, Ø 6 mm, 2 x 1 m silicone tube (black and white), 100 mm length stainless steel tube Ø 6 mm, 2 cables with mini-DIN connector for measuring probes (in option). 2 lithium ion rechargeable batteries, with USB / mains adapter cable, micro SD card for data storage, calibration certificate and transport case. Optional: all measuring modules and probes, all temperature probes, software, printer.
	MP 210	24730	✓	✓	-	✓	✓	✓	<p>MP 210 Multi-probe portable thermo-anemo-manometer</p> <ul style="list-style-type: none"> With backlit graphic display, 2 input channels for measuring probes and Pt100 temperature probes (-200 to +600 °C), output for PC and printer. Functions: pressure, temperature, air velocity and airflow. Supplied SOLE, with 1 cable with mini-DIN connector, for measuring probes (optional), Lithium Ion rechargeable battery with USB / power supply adapter cable, 2 x 1 m of silicone tube 4 x 7, one 100 mm length stainless steel tube Ø 6 mm, transport case. Optional: pressure modules, 4 thermocouple channels, air velocity and temperature probes (wired or wireless), CO, gas leak, tachometry, software and printer.
	VT 210	24736	-	✓	✓	✓	✓	-	<p>VT 210 Multi-probe portable thermo-hygro-anemometer,</p> <ul style="list-style-type: none"> With graphic backlit display, 2 input channels for measuring probes and Pt100 (-200 to +600 °C) temperature probes, output for PC and printer. Functions: air velocity, airflow, hygrometry, temperature. Supplied SOLE with 2 cables with mini-DIN connector for measuring probes (optional), Lithium Ion rechargeable battery with USB cable / power supply adapter cable, and transport case. Optional: probes for air velocity, hygrometry and temperature (wire or wireless), multi-function probe, tachometry, 4 thermocouple channel and climatic conditions module, software and printer.
	HQ 210	24745	-	✓	✓	-	-	✓	<p>HQ 210 Multi-probe portable thermo-hygrometer-air quality</p> <ul style="list-style-type: none"> With graphic backlit display, 2 input channels for measuring probe and Pt100 (-200 to +600 °C) temperature probe, output for PC and printer. Functions: hygrometry, temperature, CO and CO₂. Supplied SOLE, with 2 cables with mini-DIN connector for measuring probe (optional). Lithium Ion rechargeable battery with USB cable / power supply adapter cable, and transport case. Optional: climatic conditions modules, hygrometry and temperature probes (wire or wireless), CO/CO₂ probes, omni-directional probe, software.







Customised Products

If you are looking for a product (instrument, probe, accessory) not included in this list, please contact us. We can supply a wide range of specific products on request (delivery times may be longer).





Differential pressure

PRODUCT	ITEM	REF.	MEASURED PARAMETERS							DESCRIPTION
			Pa	°C/°F	%RH	m/s	m³/h	ppm		
	MP 110	24615	✓	-	-	-	-	-	<p>MP110 Portable micro-manometer with integrated pressure sensor (-1000 to +1000 Pa)</p> <ul style="list-style-type: none"> 2-line display. Functions: pressure, Hold/Min/Max, backlight, change of unit, configurable automatic switch-off, manual auto-zero. Supplied with 2 x 1 m of black and white silicone tube, 100 mm length stainless steel tube Ø 6 mm. Supplied with soft case and calibration certificate. 	
	MP 115	24617	✓	-	-	-	-	-	<p>MP115 Portable micro-manometer with integrated pressure sensor (-500 to +500 mBar)</p> <ul style="list-style-type: none"> 2-line display. Functions: pressure, Hold/Min/Max, backlight, change of unit, configurable automatic switch-off, manual auto-zero. Supplied with secured pressure connections, 2 x 1 m of clear tube 4 x 6, 100 mm length stainless steel tube Ø 6 mm. Supplied with soft case and calibration certificate. 	

Temperature and humidity





	TK 61	25513	-	✓	-	-	-	-	<p>TK 61 1-channel portable thermometer (-200 to +1760 °C)</p> <ul style="list-style-type: none"> K, J, T, S, thermocouple. 2-line display. Functions: Hold/Min/Max, backlit display, alarm, change of unit, configurable auto switch-off and selection of thermocouple type. Supplied with batteries and adjustment certificate.
	TK 62	25514	-	✓	-	-	-	-	<p>TK 62 2-channel portable thermometer (-200 to +1760 °C)</p> <ul style="list-style-type: none"> K, J, T, S, thermocouple. 2-line display. Functions: Hold/Min/Max, Delta T, backlit display, alarm, change of unit, configurable auto switch-off and selection of thermocouple type. Supplied with batteries and adjustment certificate.
	Kiray 100	21664	-	✓	-	-	-	-	<p>KIRAY 100 Infrared thermometer, double laser sighting.</p> <ul style="list-style-type: none"> Measuring range: -50 to +800 °C. D:S = 20:1. Backlit display, audible alarm (high and low), adjustable emissivity. Supplied with transport cover and user manual.
	HD 110	24614	-	✓	✓	-	-	-	<p>HD110 Thermo-Hygrometer</p> <ul style="list-style-type: none"> With remote hygrometer/temperature probe, 2 m length cable, (5 to 95 %RH and -10 to +50 °C). 2-line display. Functions: relative humidity, dew point, Temperature, Hold/Min/Max, backlight, change of unit and configurable switch-off. Supplied in soft case with calibration certificate.

Air velocity and airflow





	DBM 620	26446	✓	✓	✓	✓	✓	-	<p>DBM620 Electronic airflowmeter</p> <ul style="list-style-type: none"> Measuring ranges from 35 to 4250 m³/h, -2500 to +2500 Pa, 0.2 to 10 m/s, 0 to 100 %RH, -20 to 70 °C Removable wireless pressure measuring unit for use in micromanometer and anemometer mode with different probes (Pitot tube, Debimo blade, DBM VMG velocity grid). Supplied with base including temperature and humidity probe, pressure measuring unit, 610 x 610 mm (2' x 2') hood including foldable frame and airflow straightener, frame rods with sheath, 2 x 80 cm of silicone tube. Calibration certificate and transport case. The free SmartKapp mobile App is available for data reading and processing on smartphone or tablet.
	HO 622	26451	-	-	-	✓	✓	-	<p>HO-622 Measuring hood for DBM620</p> <ul style="list-style-type: none"> Sizes 720 x 720 mm (2,36' x 2,36') Supplied with foldable frame and carrying bag.
	HO 623	26452	-	-	-	✓	✓	-	<p>HO-623 Measuring hood for DBM620</p> <ul style="list-style-type: none"> Sizes 720 x 1320 mm (2,36' x 4,33') Supplied with foldable frame and carrying bag.
	HO 624	26453	-	-	-	✓	✓	-	<p>HO-624 Measuring hood for DBM620</p> <ul style="list-style-type: none"> Sizes 420 x 1520 mm (1,38' x 4,99') Supplied with foldable frame and carrying bag.
	HO 625	26454	-	-	-	✓	✓	-	<p>HO-625 Measuring hood for DBM620</p> <ul style="list-style-type: none"> Sizes 1020 x 1020 mm (3,35' x 3,35') Supplied with foldable frame and carrying bag.

Portable instruments

Our most common articles for clean rooms and regulated environments

	PRODUCT	ITEM	REF	MEASURED PARAMETERS						DESCRIPTION
				Pa	°C/°F	%RH	m/s	m³/h	ppm	
Air velocity and airflow		LV 110	24625	-	✓	-	✓	✓	-	LV 110 Portable thermo-anemometer with Ø 100 mm vane probe <ul style="list-style-type: none"> • With remote Ø 100 mm vane probe (0.3 to 35 m/s and 0 to +50 °C). 2 m cable. • 2-line display. Functions: air velocity, airflow, airflow with cones (only with Si-K25, Si-K85 models), temperature, automatic average, detection of airflow direction, Hold/Min/Max, backlight, change of unit and configurable automatic switch-off. • Supplied with soft case and calibration certificate.
		VT 110	24621	-	✓	-	✓	✓	-	VT 110 Portable hotwire thermo-anemometer, <ul style="list-style-type: none"> • 300 mm length stainless steel remote probe Ø 8 mm (0.15 to 30 m/s and 0 to +50 °C), 2 m length cable. • 2-line display. Functions: air velocity, airflow in duct, airflow with cones (only with K35 and K75), temperature, automatic average, Hold/Min/Max, backlight and configurable automatic switch-off. • Supplied with soft case and calibration certificate.
CO ₂		AQ 110	24628	-	✓	-	-	-	✓	AQ 110 Portable CO ₂ -meter <ul style="list-style-type: none"> • With CO₂ / temperature remote probe (0 to 5000 ppm and 0 to +50 °C), 2 m cable. • 2-line display. Functions: Hold/Min/Max, backlight, change of unit and configurable automatic switch-off. • Supplied with soft case and calibration certificate.
Tachometry		CT 110	24629	-	✓	-	-	-	-	CT 110 Portable tachometer <ul style="list-style-type: none"> • With optical and contact probe (60 to 60,000 RPM and 4 to 2500 m/min), 2 m cable. • 2-line display. Functions: Hold/Min/Max, backlight, change of unit, configurable automatic switch-off. • Supplied with 1 m reflective tape, soft case and calibration certificate.

Accessories

	ACCESSORIES	ITEM	REF	MEASURED PARAMETERS						DESCRIPTION
				Pa	°C/°F	%RH	m/s	m³/h	ppm	
		SFC 300	24759	-	✓	-	✓	✓	-	SFC-300 Hotwire probe (0.15 to 30 m/s and 0 to +50 °C) <ul style="list-style-type: none"> • Stainless steel body, Ø 8 mm, 300 mm length. • Smart-2014 recognition system. Supplied with adjustment certificate. • For class 210 and 310 portable instruments.
		SFC 900	24760	-	✓	-	✓	✓	-	SFC-900 Telescopic hotwire probe (0.15 to 30 m/s and 0 to +50 °C) <ul style="list-style-type: none"> • 1 m length, with graduation, swivelling at 90°. • With handle, multi-function button, integrated mini-DIN connector, Smart-2014 recognition system. • Supplied with adjustment certificate. For class 210 and 310 portable instruments.
		SH 100	24767	-	✓	-	✓	✓	-	SH-100 Ø 100 mm vane probe (0.3 to 35 m/s and -20 to +80 °C) <ul style="list-style-type: none"> • With handle, multi-function button, integrated mini-DIN connector, Smart-2014 recognition system. Supplied with adjustment certificate. • For MP 210, VT 210 and AMI 310.
		SHF 100	24779	-	✓	-	✓	✓	-	SHF-100 Wireless Ø 100 mm vane probe (0.3 to 35 m/s and -20 to +80 °C) <ul style="list-style-type: none"> • Wireless transmission system, with handle and multi-function button. • Supplied with adjustment certificate. For class 210 and 310 instruments.
		SCOH 112	24776	-	✓	✓	-	-	✓	SCOH-112 Multi-function probe for CO ₂ -temperature-hygrometry (0 to 5000 ppm / -20 to 80 °C / 5 to 95 %RH) <ul style="list-style-type: none"> • With handle, multi-function button, integrated mini-DIN connector, Smart-2014 recognition system. Supplied with adjustment certificate. • For HQ 210 and AMI 310.

ACCESSORIES	ITEM	REF	MEASURED PARAMETERS							DESCRIPTION
			Pa	°C/°F	%RH	m/s	m³/h	ppm		
	SHR 110	24769	-	✓	✓	-	-	-	<p>SHR-110 ABS hygrometry probe (3 to 98 %RH and -20 to +80 °C)</p> <ul style="list-style-type: none"> • 110 mm length, Ø 13 mm, • With handle, multi-function button, integrated mini-DIN connector, Smart-2014 recognition system. Supplied with adjustment certificate. • For HQ 210, VT 210 and AMI 310. 	
	SKV 150	17156	-	✓	-	-	-	-	<p>SKV150 Class 1 thermocouple K contact probe (-20 to +90 °C) with hook and loop fastener</p> <ul style="list-style-type: none"> • For duct Ø 100 mm (maximum), with 1.50 m cable and compensated miniature male connector. 	
	SCLK 150	24648	-	✓	-	-	-	-	<p>SCLK150 K thermocouple lamella contact probe, class 1 (-50 to +250 °C)</p> <ul style="list-style-type: none"> • 150 mm length stainless steel probe Ø 6 mm, with handle, retractable cable and miniature male compensated connector. 	
	SAK 2	24818	-	✓	-	-	-	-	<p>SAK-2 Thermocouple K wire probe, class 1 (-40 to +250 °C).</p> <ul style="list-style-type: none"> • Visible welding, isolated PTFE cable, 2 m length, output on miniature male compensated connector. (Tr 99%: 3 sec). 	
	SAK 150	24646	-	✓	-	-	-	-	<p>SAK-150 Thermocouple K ambient probe, class 1 (-40 to +250 °C)</p> <ul style="list-style-type: none"> • Stainless steel perforated probe Ø 4.5 mm, 150 mm length with handle, retractable cable and miniature male compensated connector. (Tr 99%: 50 sec). 	
	SPK 150	24650	-	✓	-	-	-	-	<p>SPK-150 K thermocouple penetration probe, class 1 (-40 to +250 °C)</p> <ul style="list-style-type: none"> • Stainless steel probe Ø 4.5 mm, sharp tip, 150 mm length. • With handle, retractable cable, miniature male compensated connector (Tr 99%: 30 sec). 	
	SIPS 150	24840	-	✓	-	-	-	-	<p>SIPS 150 Pt100 immersion temperature probe (-40 to +250 °C)</p> <ul style="list-style-type: none"> • Stainless steel probe Ø 4.5 mm, 150 mm length, with handle. • Integrated mini-DIN connector, Smart-2014 recognition system. Supplied with adjustment certificate. For class 310 and 310 instruments (Tr 99%: 35 sec). 	
	STA	24771	-	-	-	-	-	-	<p>STA Optical and contact tachometry probe (60 to 60,000 RPM, 30 to 20,000 RPM and 4 to 2500 m/min)</p> <ul style="list-style-type: none"> • With handle, multi-function button, integrated mini-DIN connector, Smart-2014 recognition system. • Supplied with 1 m reflective tape, contact tip and adjustment certificate. Compatible with MP 210, VT 210 and AMI310. 	
	MPR 500	24782	✓	✓	-	-	-	-	<p>MPR-500 Pressure module, with 1 K/J/T/N thermocouple channel (-500 to +500 Pa, -200 to +1300 °C)</p> <ul style="list-style-type: none"> • With Smart-2014 recognition system. • Supplied with adjustment certificate. For MP 210 and AMI 310. 	
	MPR 2500	24783	✓	✓	-	-	-	-	<p>MPR-2500 Pressure module, with 1 K/J/T/N thermocouple channel (-2500 to +2500 Pa, -200 to +1300 °C)</p> <ul style="list-style-type: none"> • With Smart-2014 recognition system. • Supplied with adjustment certificate. For MP 210 and AMI 310. 	
	MPR 10000	24784	✓	✓	-	-	-	-	<p>MPR-10000 Pressure module, with 1 K/J/T/N thermocouple channel (-10,000 to +10,000 Pa, -200 to +1300 °C)</p> <ul style="list-style-type: none"> • With Smart-2014 recognition system. Supplied with adjustment certificate. • For MP 210 and AMI 310. 	
	TPL 06-300	12974	-	-	-	✓	✓	-	<p>Pitot tube type L, NPL model, as per NF ISO 3966 standard</p> <ul style="list-style-type: none"> • Type: TPL-06-300. • Stainless steel body, 300 mm length, Ø 6 mm, with ellipsoidal head. 	
	TPL 06-500	12975	-	-	-	✓	✓	-	<p>Pitot tube type L, NPL model, as per NF ISO 3966 standard</p> <ul style="list-style-type: none"> • Type: TPL-06-500. • Stainless steel body, 500 mm length, Ø 6 mm, with ellipsoidal head. 	
	TPS 08-1500-T	12997	-	-	-	✓	✓	-	<p>Pitot tube type S, as per ISO 10780 norm</p> <ul style="list-style-type: none"> • Type: TPS-08-1500-T. Length 1500 mm, Ø 8 mm • With protection tube Ø 28 mm. K thermocouple temperature probe, sensor integrated. • Working temperature: 1000 °C. Supplied with connection 1.5 m length cable and miniature male/female connectors. 	

Accessories

ACCESSORIES	ITEM	REF	MEASURED PARAMETERS							DESCRIPTION
			Pa	°C/°F	%RH	m/s	m ³ /h	ppm		
	K 35	10374	-	-	-	-	✓	-	K35 Airflow cone for Ø 8 mm hot wire probe <ul style="list-style-type: none"> • Dimensions: 200 x 200 mm. • Airflow from 10 to 400 m³/h, supply and exhaust. • Supplied with transport bag. 	
	K 75	10637	-	-	-	-	✓	-	K75 Airflow cone for Ø 8 mm hot wire probe <ul style="list-style-type: none"> • Dimensions: 300 x 300 mm. • Airflow from 30 to 750 m³/h, supply and exhaust. • Supplied with transport bag. 	
	Si-K25	28111	-	-	-	-	✓	-	Si-K25 Airflow cone for Ø 100 mm vane probe <ul style="list-style-type: none"> • Internal dimensions: Ø 260 mm. • External dimensions: L 282 x W 282 x H 268 mm. • Airflow: 10 to 400 m³/h, supply and exhaust. • Supplied with transport bag. 	
	Si-K85	28112	-	-	-	-	✓	-	Si-K85 Airflow cone for Ø 100 mm vane probe <ul style="list-style-type: none"> • Internal dimensions: 350 x 350 mm. • External dimensions: L 372 x W 372 x H 327 mm. • Airflow: 10 to 400 m³/h, supply and exhaust. • Supplied with transport bag. 	
	RD 300	12411	-	-	-	-	-	-	RD300 Straight extension, 300 mm length <ul style="list-style-type: none"> • For hot wire probe and vane probe Ø 14 mm. 	
	RTE	24632	-	-	-	-	-	-	RTE Ø 16 mm telescopic extension <ul style="list-style-type: none"> • 1m length, can be bent at ± 90°. • For measuring probes with handle. 	
	CSM	24837	-	-	-	-	-	-	CSM Braid cable with mini-DIN male connector <ul style="list-style-type: none"> • For measuring and Pt100 temperature probes. • For class 210 and 310 instruments. 	
	CQ 15	24633	-	-	-	-	-	-	CQ15 Protective cover with integrated magnets <ul style="list-style-type: none"> • For class 50 and 110 instruments. 	
	BAT 23	24849	-	-	-	-	-	-	BAT 23 Lithium ion rechargeable batteries <ul style="list-style-type: none"> • For class 210 and 310 instruments. 	
	SAD	24792	-	-	-	-	-	-	SAD Transport back-pack <ul style="list-style-type: none"> • For class 210 and 310 instruments and their accessories. 	
	ST 110	24635	-	-	-	-	-	-	ST110 Soft case with handle <ul style="list-style-type: none"> • For class 60 and 110 instruments (supplied with all class 110 / can be ordered separately). 	
	LPC 14	24789	-	-	-	-	-	-	LPC-14 SOLE software, for class 210 and 310 instruments.	



Customised Products

If you are looking for a product (instrument, probe, accessory) not included in this list, please contact us. We can supply a wide range of specific products on request (delivery times may be longer).

OUR EXPERTISE

ACCREDITED MEASUREMENT LABORATORIES, IN-HOUSE RESEARCH AND DEVELOPMENT

Sauermann products and services are backed by cutting-edge facilities and expertise: a team of over 20 experts working at multiple testing and calibration laboratories worldwide, and production lines in France, the United States and China.

Our in-house research and development program – spearheaded by a young, forward-looking group of 20 engineers and 10 technicians – has three aims: to push the boundaries of innovation in ergonomic design, digital technology and connected objects, to patent our technologies, and to consistently set new standards for electronic and mechanical performance in our products.



Over 800 m² of laboratory space

Our experts provide maintenance, adjustment and calibration services for our measurement instruments.



Customer service staff trained by our experts

Our team is here to advise and quote you for the service you need.

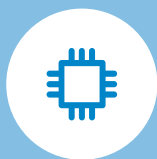

After-sales service

Our technicians maintain and repair your devices right where they're made.



Over 20 patents, including our oscillating piston pump technology and the foldable frame system found on our DBM 620 air flow meter.



Our measurement expertise covers a wide range of fields:

Pressure	Air velocity
Temperature	Air flow
Humidity	Gas analysis
Weight	Light measurement
Radiometry	Electrical current
Tachometry	Acoustics

**Sauermann Industrie,
Laboratories,
located in Montpon
(FR), accredited to
standard NF EN ISO/
IEC 17025**



TEMPERATURE



HUMIDITY

Professional solutions for condensate management and indoor air quality measurement

INsights

Case studies, useful information and practical advice for HVACR and indoor air quality professionals.

sauermanngroup.com/insights

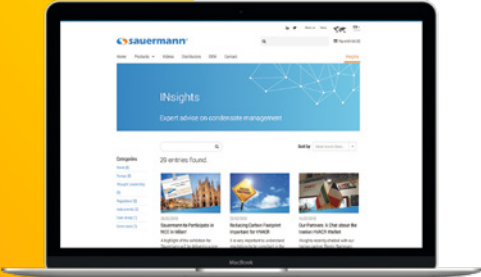

Sauermann on YouTube

Head to our YouTube channel for tutorials, webinars and product guides.

youtube.com/sauermanngroup

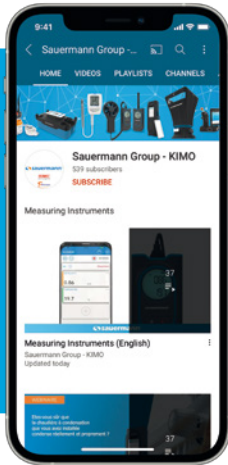

For more information, visit: sauermanngroup.com



Sauermann UK
Units 7-9 Trident Business Park
Amy Johnson Way, Blackpool
Lancashire, FY4 2RP

info.uk@sauermanngroup.com

Non-contractual document – We reserve the right to modify the characteristics of our products without prior notice.

05/2024