

PROFESSIONAL SOLUTIONS FOR CONDENSATE MANAGEMENT AND INDOOR AIR QUALITY MEASUREMENT



ABOUT US



For more than 45 years, Sauermann Group has designed, manufactured and sold products and services dedicated to the industrial and HVACR markets. The Group specifically focuses on the detection, measurement and control of indoor air quality (IAQ).

HIGH ACCURACY
UNMATCHED RELIABILITY
MULTIPLE APPLICATIONS

Measurement instruments: Sauermann measurement instruments monitor a broad spectrum of indoor air quality parameters and serve a wide range of applications, from building ventilation (heating and air conditioning) systems, to cold-chain installations and combustion gas analysis. Backed by our testing laboratories and in-house research and development programme, Sauermann instruments deliver the accuracy and reliability that HVACR engineers need.

LOW SOUND LEVEL
LOW FAIL RATE
HIGH PERFORMANCE

Condensate management solutions: Safe and effective condensate management for air quality systems can be a challenge. Sauermann pumps are designed to look good, while our patented piston technology delivers whisper-quiet operation and unrivalled reliability.



Heating



Ventilation



Air conditioning



Refrigeration

OUR PRODUCTS & MARKETS

● **Climate systems engineering:**

Heating & air conditioning installers, inspection bodies, technical consulting firms, air treatment unit manufacturers, system tuners, operation & maintenance contractors, etc.

◆ **High-tech industries:**

Pharmaceutical & cosmetics laboratories, electronics manufacturers, etc.

◆ **Heavy industries:** Food processing, paper, automotive, nuclear, etc.

■ **Commercial:** Hospitals, glasshouses, museums, farms, temperature-controlled transport, etc.

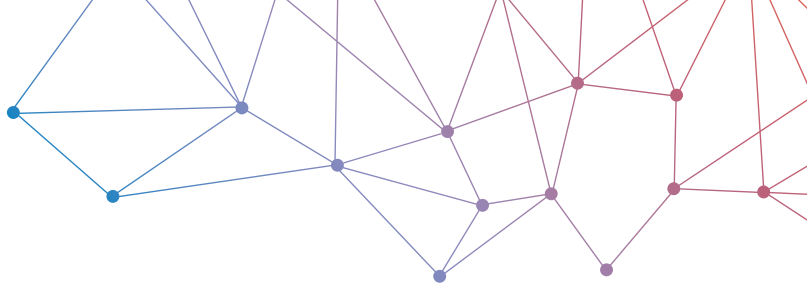

OUR EXPERTISE

ACCREDITED MEASUREMENT LABORATORIES, IN-HOUSE RESEARCH AND DEVELOPMENT



Sauermann products and services are backed by cutting-edge facilities and expertise: a team of over 20 experts working at multiple testing and calibration laboratories worldwide, and production lines in France, the United States and China.

Our in-house research and development programme – spearheaded by a young, forward-looking group of 20 engineers and 10 technicians – has three aims: to push the boundaries of innovation in ergonomic design, digital technology and connected objects, to patent our technologies, and to consistently set new standards for electronic and mechanical performance in our products.



Over 20 patents, including our oscillating piston pump technology and the foldable frame system found on our DBM 620 air flow meter.

Over 800 sq m of laboratory space

Our experts provide adjustment and calibration services for our measurement instruments.

Customer service staff trained by our experts

Our team is here to advise and quote you for the service you need.

After-sales service within our production lines

Our technicians maintain and repair your devices right where they're made.

Our measurement expertise covers a wide range of fields:

Pressure	Radiometry	Gas analysis
Temperature	Tachometry	Light measurement
Humidity	Air velocity	Electrical current
Weighing	Air flow	Acoustics

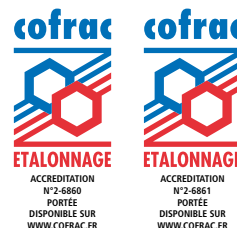

TEMPERATURE HUMIDITY

Sauermann Industrie, Laboratories, located in Montpon (FR), accredited to standard NF EN ISO/IEC 17025



Accreditation Sauerermann Iberica ENAC UNE EN 17025 : 2017



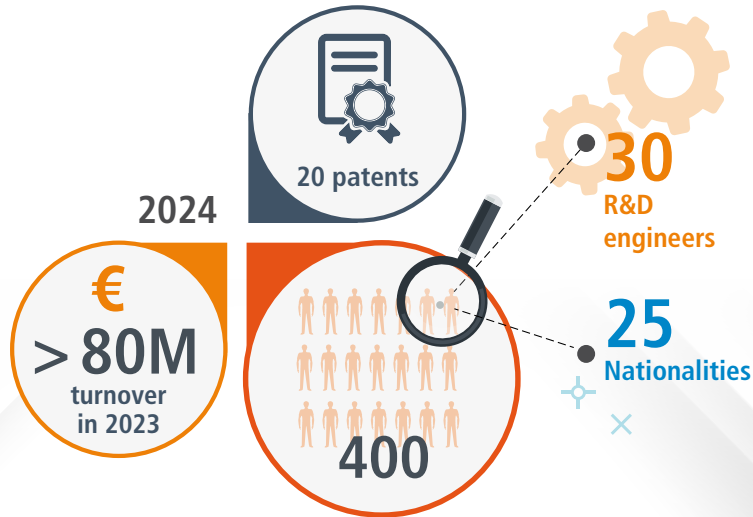

2019
Sauermann Group acquires Megatech



2020
Sauermann and Kimco merge their companies



2015
Sauermann and Kimco join forces



2018
Sauermann Group acquires E Instruments in the U.S.

4 Factories

12 Sites

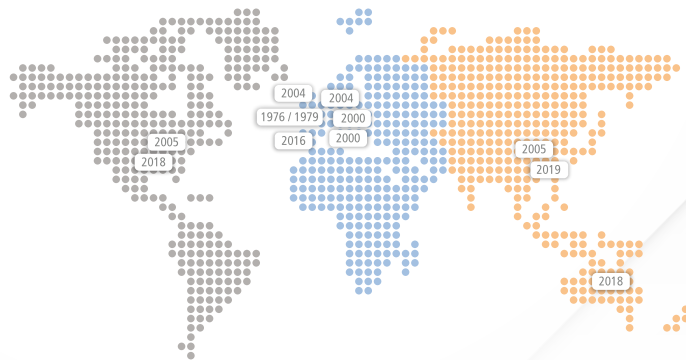

1985
Expansion into Indoor Air Quality digital measuring tools.

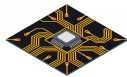

1993
Sauermann Group is the first to launch a condensate removal pump with piston technology.

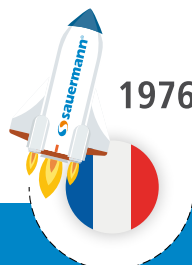

1976

Contents

HVACR MEASUREMENT INSTRUMENTS

NEW

08



COMBUSTION GAS ANALYSERS

16



DELTA PACK

39



Si- 1931

ANTI-BIOFILM SOLUTION

51



HVACR measurement instruments 08

Mobile app	09
Applications	10
Si-PM3, Si-TT3, Si-HH3, Si-TI3	12
Si-VV3, Si-VH3, Si-CD3, Si-RD3	13
Technical information	14
Measuring ranges	15

Combustion gas analysers 16

Features	17
Si-CA 030	18
Si-CA 130	19
Si-CA 230	20
Mobile app	21
Selection guide	22
Available kits	23
Accessories	24
Applications	25

Digital manifold 26

Product overview	27
Si-RM3	28
Si-RV3	30
Si-RM13	31
Si-Manifold	32

Mini pumps 36

Applications	38
Delta pack, Si-10	39
Omega pack, Si-20	40
Si-30, Si-33	41
Si-60	42
PE 5000, PE 5100, PE 5200	43

Tank pumps 44

Applications	45
Si-82	46
Si-83	47
SI 1805	48
Si-1830, SI 1850	49
Si-2052	50
Si-1931	51

Accessories 52

Pipes and fittings	52
Detection mini pumps	53
Centrifugal pumps	54
Neutralization	54
Miscellaneous	54
Anti biofilm	54

MEASUREMENT INSTRUMENTS

Check. View. Optimise.



Heating



Ventilation



Air conditioning



Refrigeration



HVACR MEASUREMENT
INSTRUMENTS



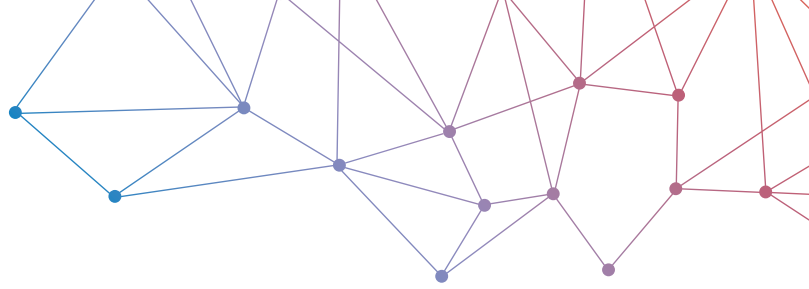

Sauermann's measurement instruments are backed by a 45-year track record in metrology, delivering unmatched reliability and a user experience that's second to none.

At Sauermann, our experience means we understand the needs of professionals the world over – and design tools to help them do their job better. Our instruments monitor the full spectrum of air quality parameters, catering to the entire HVACR and indoor air quality sector.

Indoor air quality Heat pumps Heating Healthcare High-tech industries Laboratories
Transport Residential, commercial & industrial boilers Environment Refrigeration Cold chain
Energy efficiency Air conditioning Research Livestock farming Combustion efficiency and emissions Agriculture



COMBUSTION GAS ANALYSERS



DIGITAL MANIFOLDS



HVACR measurement instruments

It's all about simplicity

Pressure / Temperature / Humidity / Air velocity / Air flow rate



Among other applications, the Si-PM3 differential pressure manometer can be used to check air treatment unit filters for clogging.

Our portable HVACR instruments cover a broad spectrum of measurements, from temperature, relative humidity and pressure, to air velocity and air flow rate.

We offer a full range of easy-to-use instruments: dual input thermometer (Si-TT3), infrared thermometer (Si-TI3), thermo-hygrometer (Si-HH3), digital differential pressure manometer (Si-PM3), vane thermo-anemometer (Si-VV3), hotwire thermo-anemometer (Si-VH3), gas leak detector (Si-CD3) and refrigerant leak detector (Si-RD3).

What's more, our user-friendly Si-HVACR Measurement MobileApp displays measurement data right on your smartphone or tablet.



Mobile app

Si-HVACR Measurement MobileApp

With the Si-HVACR Measurement MobileApp, users can view and record measurements in real time.

Key features:

- View parameters in user-friendly format
- Access previously saved measurements and charts (average, min. & max. values, etc.)
- Generate reports (PDF, CSV or XML) and add up to four photos

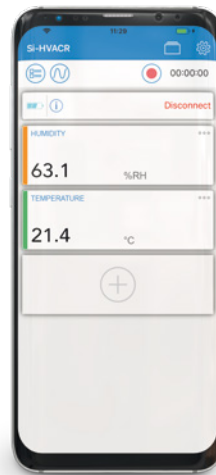

Backlit LCD screen



Low consumption device



Magnetic backing for easy fixing



Carrying bag



Calculated values on mobile app

Applications

Our devices provide everything HVACR engineers need for their routine operations

MEASURE AIR VELOCITY, FLOW RATE AND TEMPERATURE AT GRILLES



CHECK INLET AND OUTLET TEMPERATURES FOR WATER HEATING SYSTEMS

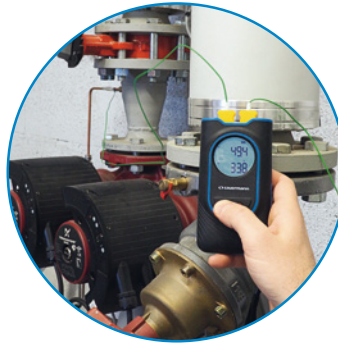

MEASURE DIFFERENTIAL PRESSURE BETWEEN THE FILTER INLET AND OUTLET ON AN AIR TREATMENT UNIT

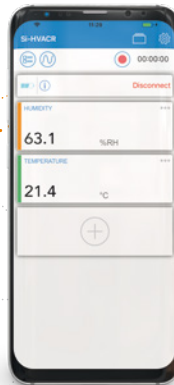

Remote control; records readings and sends reports
(except Si-CD3 and Si-RD3 models)



CHECK INLET AND OUTLET TEMPERATURES FOR DOMESTIC HOT WATER SYSTEMS



MEASURE AIR VELOCITY, FLOW RATE AND TEMPERATURE IN A PIPE



MEASURE AMBIENT AIR TEMPERATURE AND RELATIVE HUMIDITY (DEW POINT AND WET BULB TEMPERATURE ARE CALCULATED)



DETECTS REFRIGERANT LEAKS FROM A COOLING UNIT



DETECTS LEAKS OF COMBUSTIBLE GASES UPSTREAM OF A BOILER BURNER





Heating



Ventilation Air conditioning



Refrigeration

 <p>SI-PM3 Digital differential pressure manometer</p>	<p>Gas-fired boilers</p> <ul style="list-style-type: none"> - Measure pressure at the gas inlet valve. - Measure pressure drop (draught) at the flue. 	<p>Ventilation circuit</p> <ul style="list-style-type: none"> - Check filter fouling. - Measure extractor fan pressure and air flow rate. - Measure air flow in a pipe. 	
<p>Tip : connect a Pitot tube to the instrument to measure air flow in a pipe. Use the smartphone app to calculate air flow rate by entering the pipe coefficient.</p>			
 <p>SI-TT3 Dual input thermocouple thermometer</p>	<p>Hot water boilers</p> <ul style="list-style-type: none"> - Compare the water temperature in the boiler inlet, outlet and return pipes. 	<p>Multifunction</p> <ul style="list-style-type: none"> - Ambient air temperature. - Air temperature in the pipes. - Temperature in domestic hot water systems. 	<p>Refrigerators, freezers</p> <ul style="list-style-type: none"> - Measure superheat and sub-cooling of the refrigerant gas circuit.
<p>Tip : a vital add-on for working on refrigeration systems if your manifold does not include a temperature probe.</p>			
 <p>SI-TI3 Infrared thermometer</p>	<p>Radiators</p> <ul style="list-style-type: none"> - Measure radiator hot and cold spots to determine if venting is required. 		
<p>Tip : vastly improves speed and convenience (measurements delivered remotely in real time). Can measure ambient temperature (via app). Capable of checking various temperature increases, including electrical heating. Affix a black strip on non-black surfaces and adjust the emissivity of the surface (as per the manual) for accurate measurement.</p>			
 <p>SI-HH3 Thermo-hygrometer</p>		<p>Ventilation</p> <ul style="list-style-type: none"> - Measure ambient air temperature and relative humidity. 	
<p>Tip : extreme relative humidity values (too high or too low) can pose hazards (allergies, germs, dust, mould, etc.). The app displays psychometric parameters such as dew point and wet bulb temperature.</p>			
 <p>SI-VV3 Vane thermo-anemometer</p>		<p>Air conditioning circuit</p> <ul style="list-style-type: none"> - Measure air flow through system inlet and outlet grilles. 	
<p>Tip : input the pipe cross-section in the app to calculate average air flow rate in addition to air velocity.</p>			
 <p>SI-VH3 Hotwire thermo-anemometer</p>		<p>Air conditioning circuit</p> <ul style="list-style-type: none"> - Measure air flow in pipes (and temperature). 	
<p>Tip : input the pipe cross-section dimensions in the app to calculate average air flow rate in addition to air velocity. Use the hotwire thermo-anemometer instead of a vane thermo-anemometer for low-velocity or laminar air flows.</p>			
 <p>SI-CD3 Gas leak detector</p>	<p>Gas-fired boilers</p> <p>Detects leaks of combustible gases upstream of the boiler, at the inlet and inside the unit.</p>		
<p>Tip : a flexible probe keeps the device's sensor in contact with gas pipes in even the hardest-to-reach places. Pay special attention to joints in the circuit. Check the condition of the filter and replace it if necessary. Follow the manufacturer's recommendations for replacing the sensor.</p>			
 <p>SI-RD3 Refrigerant leak detector</p>	<p>Heat pumps</p>	<p>Air-conditioning units</p>	<p>Refrigerators, freezers</p> <p>Detects refrigerant leaks in every part of the cooling circuit.</p>
<p>Tip : a flexible probe keeps the device's sensor in contact with gas pipes in even the hardest-to-reach places. Pay special attention to joints in the circuit. Check the condition of the filter and replace it if necessary. Follow the manufacturer's recommendations for replacing the sensor.</p>			

Si-PM3

Digital differential pressure manometer

This pocket-sized manometer can take two pressure measurements simultaneously, and you can connect a Pitot tube to measure air velocity and flow rate in a pipe.

Reference: SIPM3



Air velocity and air flow with Pitot tube (optional)



Measuring range: -150 to +150 hPa (-60 to 60 inH₂O)



Si-TT3

Dual input thermocouple thermometer

This instrument uses thermocouple technology to take two temperature readings at once (between -200 °C/-328 °F and 1 300 °C/2 372 °F). Ideal for checking the inlet and outlet temperatures of water heating systems.

Reference: SITT3



Dual channel K thermocouple (2 probes included)



Accessory : 1 x K thermocouple wire probe class 2, between -40 and +260 °C (40 to 500 °F) (reference : SIACCTC)

Si-HH3

Thermo-hygrometer

This thermo-hygrometer is a turnkey solution for measuring temperature and relative humidity, while dew point and wet bulb temperature are calculated via the accompanying mobile app.

Reference: SIHH3



Measuring range: from 0 to 100%RH



Si-TI3

Infrared thermometer

Sauermann's Si-TI3 infrared thermometer is the ideal solution for contactless diagnosis, inspection and checking of surface temperatures.

Reference: SITI3



Optical: D.S 12:1



Adjustable emissivity

Si-VH3

Hotwire thermo-anemometer with telescopic probe

Sauermann's palm-sized Si-VH3 hotwire thermo-anemometer comes with a highly sensitive and accurate telescopic probe that easily measures air flow rate, velocity and temperature.

Reference: SIVH3



80 cm (31.5") telescopic probe with double graduation



Si-W3

Vane thermo-anemometer with built-in vane probe

This thermo-anemometer, which features a vane probe with a long cable, can be used to measure air velocity and temperature at an air vent. Air flow rate is calculated via the accompanying mobile app.

Reference: SIVV3



Air velocity and air flow meter



Large vane probe with 2 m (78.74") cable

Si-CD3

Gas leak detector

The Si-CD3 gas leak detector is perfect for quickly and easily detecting even the slightest leaks of various combustible gases (methane, propane, isobutane, LPG and other hydrocarbons).

Reference: SICD3



30 cm flexible probe



Adjustable alarm



Si-RD3

Refrigerant leak detector

The Si-RD3 refrigerant leak detector uncovers leaks of most common refrigerant gases to a high degree of sensitivity, including all HCFC and HFC refrigerants, R1234yf, R1234ze, R290, R600a, and 5% hydrogen–95% nitrogen mixtures (Nidron 5 and Trace-A-Gas).

Reference: SIRD3



30 cm flexible probe



Visual and audio alarm

Technical information



Si-PM3 Si-HH3 Si-TT3 Si-TI3 Si-VV3 Si-VH3 Si-CD3 Si-RD3

Differential pressure	✓	-	-	-	-	-	-	-
Air velocity and air flow rate with Pitot tube (optional)	✓	-	-	-	-	-	-	-
Relative humidity	-	✓	-	-	-	-	-	-
Dew point	-	✓	-	-	-	-	-	-
Absolute humidity	-	✓	-	-	-	-	-	-
Enthalpy	-	✓	-	-	-	-	-	-
Mixing ratio	-	✓	-	-	-	-	-	-
Wet bulb temperature	-	✓	-	-	-	-	-	-
NTC temperature	-	✓	-	-	✓	✓	-	-
K thermocouple temperature	-	-	✓	-	-	-	-	-
Infrared temperature	-	-	-	✓	-	-	-	-
Ambient temperature	-	✓	-	✓	-	-	-	-
Air velocity	-	-	-	-	✓	✓	-	-
Air flow	-	-	-	-	✓	✓	-	-
Combustible gases	-	-	-	-	-	-	✓	-
Refrigerant gases	-	-	-	-	-	-	-	✓
Carrying bag	✓	✓	✓	✓	✓	✓	✓	✓
Magnet at backside	✓	✓	✓	-	✓	✓	-	-
Auto shut-off	10 min	10 min	10 min	15 sec	10 min	10 min	0 to 120 min	15 min
Battery life	170 h	250 h	400 h	14 h	120 h	20 h	20 h	> 12 h
Mobile app	✓	✓	✓	✓	✓	✓	-	-
Warranty	2-year	2-year	2-year	2-year	2-year	2-year	2-year	2-year

Measuring ranges



	Si-PM3	Si-HH3	Si-TT3	Si-TI3	Si-VV3	Si-VH3	Si-CD3	Si-RD3
Differential pressure	-150 to +150 hPa -60 to 60 inH ₂ O	-	-	-	-	-	-	-
Air velocity with Pitot tube (optional)	2 to 80 m/s 394 to 15,748 fpm	-	-	-	-	-	-	-
Air flow rate with Pitot tube (optional)	0 to 9,999 m ³ /h	-	-	-	-	-	-	-
Relative humidity	-	0 to 100 %HR	-	-	-	-	-	-
Dew point	-	-40 to +60 °C _{td} -40 to 140 °F _{td}	-	-	-	-	-	-
Absolute humidity	-	0 to 600 g/m ³	-	-	-	-	-	-
Enthalpy	-	0 to 10,000 kJ/kg	-	-	-	-	-	-
Mixing ratio	-	0 to 10,000 g/kg	-	-	-	-	-	-
Wet bulb temperature	-	0 to 60 °C _{tw} 32 to 140 °F _{tw}	-	-	-	-	-	-
NTC temperature	-	-20 to +60 °C -4 to 140 °F	-	-	-10 to +60 °C 14 to 140 °F	-10 to +60 °C 14 to 140 °F	-	-
K thermocouple temperature	-	-	-200 to +1,300 °C -328 to 2,372 °F	-	-	-	-	-
Infrared temperature	-	-	-	-40 to +500 °C -40 to 932 °F	-	-	-	-
Ambient temperature	-	-20 to +60 °C -4 to 140 °F	-	0 to 50 °C 32 to 122 °F	-	-	-	-
Air velocity	-	-	-	-	0,4 to 30 m/s 78.7 to 5,905 fpm	0 to 30 m/s 0 to 5,905 fpm	-	-
Air flow rate	-	-	-	-	0 to 9,999 m ³ /h 0 to 9,999 m ³ /min 0 to 9,999 m ³ /s 0 to 9,999 cfm	0 to 9,999 m ³ /h 0 to 9,999 m ³ /min 0 to 9,999 m ³ /s 0 to 9,999 cfm	-	-
CH ₄	-	-	-	-	-	-	0 to 10,000 ppm 0 to 1% vol 0 to 20% LEL	-
Refrigerant gases	-	-	-	-	-	-	-	0 to 3 g/year 0 to 30 g/year 0 to 300 g/year

Combustion gas analyzers

A new degree of efficiency



Our combustion gas analyzers are ideal for maintaining combustion equipment, covering the full range of operations in residential, commercial and industrial applications.

Sauermann offers a range of compact and intuitive analysers to enhance your performance.

Sauermann's combustion gas analyzers feature the latest digital and metrology technologies, making measurements more reliable and cutting the amount of time heating engineers need to spend on-site. A user experience like no other!

Applications

- Boilers
- Burners
- Water heaters
- Gas and diesel engines
- Furnaces
- Industrial kilns
- Industrial heating systems
- Incinerators



Residential



Commercial



Industrial

Features

Add a digital edge to your combustion analysis



Auto pump cut-off for high CO levels (adjustable)



Predictive maintenance with estimated sensor life & calibration reminders



Draft & differential pressure measurements



Mobile phone app for real-time remote display & control



Calculations for Combustion Efficiency, Excess Air, & CO₂%



Data management with automatic logging & report creation



Si-CA 030



Si-CA 130



Si-CA 230

LCD display size	2.8 inches	4.3 inches	4.3 inches
Display resolution	320 x 240 pixels	480 x 272 pixels	480 x 272 pixels
Touch-screen display	No (5 buttons)	Yes (+ on/off button)	Yes (+ on/off button)
Dimensions (H x W x D)	9,9 x 19,4 x 4,9 cm 7.5 x 3.5 x 1.6"	9,9 x 19,4 x 4,9 cm 7.5 x 3.5 x 1.6"	11,2 x 28 x 5,5 cm 11 x 4.3 x 2"
Weight	350 g - 12 oz	350 g - 12 oz	825 g - 30 oz
No. of cells	Up to 3 (O ₂ , CO, NO)	Up to 3 (O ₂ , CO, NO, Low NO)	Up to 6 (O ₂ , CO, NO, Low NO, NO ₂ , Low NO ₂ , SO ₂ , Low SO ₂ , CxHy, H ₂ S)
Max. CO measurement	8,000 ppm	8,000 ppm	50,000 ppm (with dilution)
CO dilution	-	-	✓
Field replaceable pre-calibrated sensors	-	✓	✓
Flue gas velocity with Pitot tube	-	✓	✓
Measurement storage	Smartphone	Internal: 2,000 data points + Smartphone and PC	Internal: 2,000 data points + Smartphone and PC
PC software (wireless & USB)	-	✓	✓
Smartphone app (wireless)	✓	✓	✓
Combustion Applications	Residential, Commercial	Residential, Commercial	Commercial, Industrial



To see our extensive range of other measurement instruments for heating applications, go to www.sauermann.com

Si-CA 030

All the essentials for combustion gas analysis

The Si-CA 030 offers everything heating engineers need to inspect and maintain residential and commercial boilers, with wireless connection to our smartphone app and automatic generation of servicing reports and certificates.



Up to three gas sensors:
O₂, CO and NO (for NOx)



Auto pump cut-off
for high CO levels

- NOx capable with NO sensor
- Quick and easy pump On/Off control
- CO safety monitoring in ambient air

LIGHTWEIGHT
350 g



Common features Si-CA 030 / Si-CA 130

- Predictive maintenance with estimated sensor life & calibration reminders
- Draft & differential pressure measurements
- Calculated CO₂% value
- CO safety monitoring in ambient air



**CO measurement up to
8,000 ppm**



Color display

Si-CA 130

Comprehensive, versatile analyzer with touch-screen display

The Si-CA 130 features a touch-screen display and comes with PC-based management software (in addition to the smartphone app) for more in-depth combustion gas analysis. The three field-replaceable cells and sensors offer expanded measurement capability.



Up to three gas sensors O₂, CO, and NO or Low NO (for NO_x)



Field replaceable precalibrated sensors

- Auto pump cut-off for high CO levels (user-adjustable)
- NO_x capable with NO sensor (optional)
- One Touch Pump On/Off with Purge
- PC software with wireless and USB connectivity
- Graphical data display
- Customisable gas analysis screen

- Combustion efficiency and excess air calculations
- Protective rubber casing
- Maintenance agreements and extended warranties available
- Emissions values adjusted for reference O₂



Data management with automatic logging & report creation through app/PC software



Lightweight, only 350 g (12 oz)

19.4 cm - 7.5"

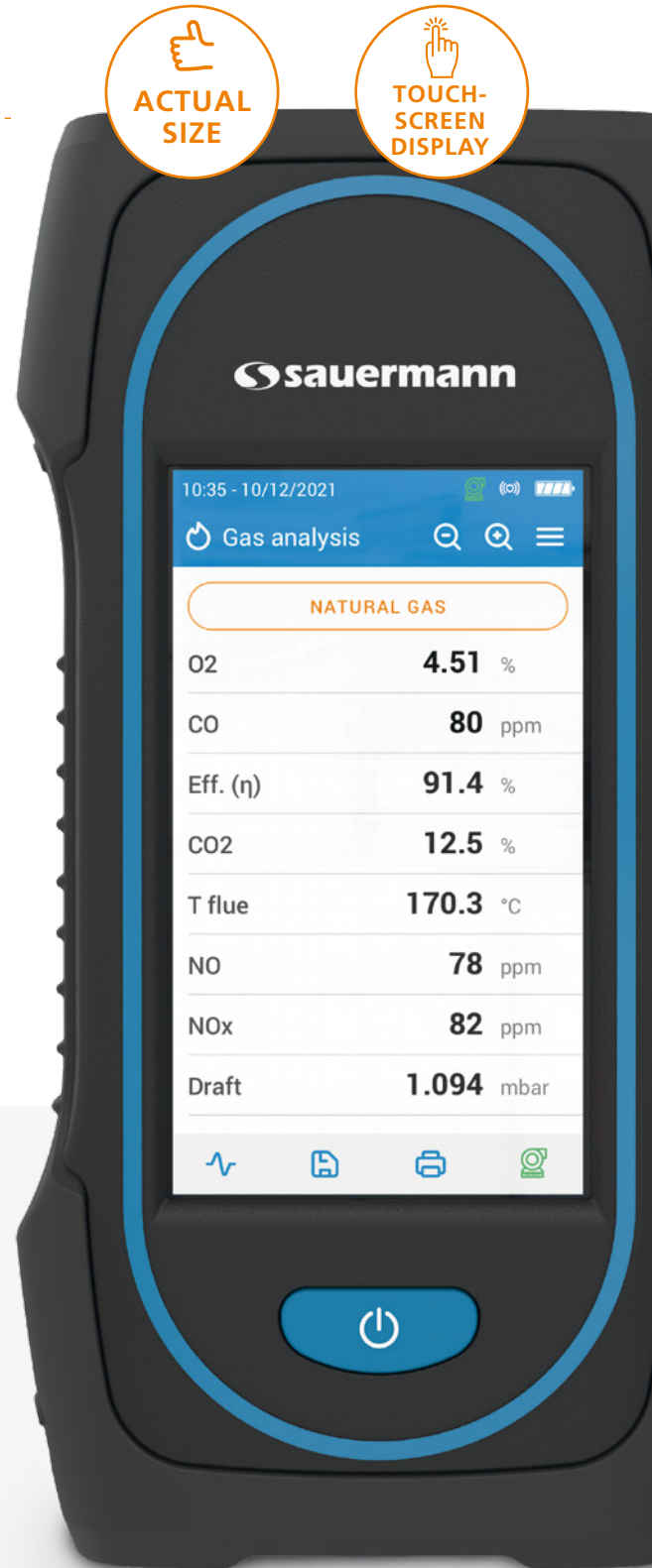

Si-CA 230

State-of-the-art, industrial emissions analyzer



With up to six gas sensors and expanded measurement capabilities, the Si-CA 230 is well suited for boilers, burners, engines, and other industrial combustion applications. And with support for more gases and a high CO tolerance threshold, its versatility makes it the ideal choice across commercial and industrial applications.



Up to Six Gas Sensors. Can include
O₂, CO, NO, Low NO, NO₂, Low NO₂,
SO₂, Low SO₂, H₂S, and CxHy



CO Dilution auto-range
with measurements to
50,000 ppm



Total NOx & Low NOx
Capable



Field Replaceable
Pre-Calibrated Sensors



Features: Si-CA 230

- Ergonomic, light weight, & durable design
- Data management with automatic logging & report creation
- Predictive maintenance with estimated sensor life & calibration reminders
- One touch pump On/Off with purge
- PC software with wireless and USB connectivity
- Auto pump cut-off for high CO levels
- Graphical data display
- Customisable gas analysis screen
- Stack gas velocity with Pitot tube
- Draft and differential pressure measurements
- Emissions values adjusted for reference O₂
- CO safety monitoring in ambient air
- Protective rubber holster
- Maintenance contracts and extended warranties available

Mobile app

Sauermann Combustion

The Sauermann Combustion app lets you control your Si-CA analyzer remotely, view measurement results in real time, and customise them before exporting in the format of your choice.



- Free apps for iOS & Android mobile devices
- PC software with USB & wireless connectivity
- Fast, easy wireless connection
- Remote live view of combustion analysis data as list or graph
- Remote control to change settings
- Data saving, including automatic logging
- Report creation in PDF, CSV (for Excel) and XML formats
- Databases for customers, operators, & equipment

Download Sauermann Combustion app



Warranty

All devices come with a two-year warranty against manufacturing defects (subject to assessment by our after-sales department).

To find out more about our extended warranties and maintenance plans, please visit our website, or contact our Customer Service Department.



Selection guide

Technical information





Si-CA 030

Si-CA 130

Si-CA 230

Parameter	Measuring range	Si-CA 030	Si-CA 130	Si-CA 230
# of Gas Sensors		2 - 3	2 - 3	2 - 6
O ₂	0 to 25%	✓	✓	✓
CO	0 to 8000 ppm	✓	✓	-
CO (H ₂ comp.)	0 to 10,000 ppm	-	-	✓
CO (with dilution)	100 to 50,000 ppm	-	-	✓
CO ₂ (calculated)	0 to 99.9%	✓	✓	✓
NO	0 to 5000 ppm	✓	✓	✓
Low NO	0 to 300 ppm	-	✓	✓
NO ₂	0 to 1000 ppm	-	-	✓
Low NO ₂	0 to 100 ppm	-	-	✓
NOx (calculated)	0 to 7500 ppm	✓	✓	✓
Low NOx (calculated)	0 to 450 ppm	-	✓	✓
SO ₂	0 to 5000 ppm	-	-	✓
Low SO ₂	0 to 100 ppm	-	-	✓
CxHy (HC)	0 to 5%	-	-	✓
H ₂ S	0 to 500 ppm	-	-	✓
Flue temperature	-20 to +1250 °C / -4 to +2282 °F	✓	✓	✓
Air temperature	-40 to +120 °C / -40 to +482 °F	✓	✓	✓
Differential temperature	0 to 1250 °C / 0 to 2282 °F	✓	✓	✓
Pressure/Draft	-200 to 200 mbar / -80 to 80 inH ₂ O	✓	✓	✓
High accuracy draft	-500 to +500 Pa	-	✓	✓
Excess air	0 to 999%	✓	✓	✓
Efficiency	0 to 100% (Gross/HHV)	✓	✓	✓
Efficiency (condensation)	0 to 125% (Net/LHV)	✓	✓	✓
Stack Gas velocity	0 to 99 m/s / 0 to 19,500 fpm	-	✓	✓
Application		Residential/ Light Commercial	Residential/ Commercial	Commercial/ Industrial

Features

Wireless Printer	Optional	Optional	Optional
Field-Replaceable Pre-Calibrated Sensors	-	✓	✓
Real time display of data on the smartphone	 	✓	✓
PC Software	-	✓	✓
Automatic Data Logging	✓	✓	✓
Rechargeable Battery w/ AC Charger	✓	✓	✓

Available kits

20 main packs

27496	SICA 030 KIT 2AS	O ₂ /CO	180	Vinyl	Si-CA 030 Gas Analyzer Kit 2AS, includes two gas sensors (O ₂ , CO), 180 mm Probe rated to 800C with 2 m dual hose, vinyl carrying case, rubber holster, water trap with filter, charger with plug set, USB-C cable, quick start guide, calibration certificate
27498	SICA 030 KIT 2BS	O ₂ /CO	300	Vinyl	Si-CA 030 Gas Analyzer Kit 2BS, includes two gas sensors (O ₂ , CO), 300 mm Probe rated to 800C with 3 m dual hose, vinyl carrying case, rubber holster, water trap with filter, charger with plug set, USB-C cable, quick start guide, calibration certificate
27501	SICA 030 KIT 3AS	O ₂ /CO/NO	180	Vinyl	Si-CA 030 Gas Analyzer Kit 3AS, includes three gas sensors (O ₂ , CO, NO), 180 mm Probe rated to 800C with 2 m dual hose, vinyl carrying case, rubber holster, water trap with filter, charger with plug set, USB-C cable, quick start guide, calibration certificate
27507	SICA 130 KIT 2AS	O ₂ /CO	180	Vinyl	Si-CA 130 Gas Analyzer Kit 2AS, includes two gas sensors (O ₂ , CO), 180 mm Probe rated to 800C with 2 m dual hose, vinyl carrying case, rubber holster, water trap with filter, charger with plug set, USB-C cable, quick start guide, calibration certificate
27508	SICA 130 KIT 2AH	O ₂ /CO	180	ABS	Si-CA 130 Gas Analyzer Kit 2AH, includes two gas sensors (O ₂ , CO), 180 mm Probe rated to 800C with 2 m dual hose, ABS hard plastic carrying case, rubber holster, water trap with filter, charger with plug set, USB-C cable, quick start guide, calibration certificate
27509	SICA 130 KIT 2BS	O ₂ /CO	300	Vinyl	Si-CA 130 Gas Analyzer Kit 2BS, includes two gas sensors (O ₂ , CO), 300 mm Probe rated to 800C with 3 m dual hose, vinyl carrying case, rubber holster, water trap with filter, charger with plug set, USB-C cable, quick start guide, calibration certificate
27510	SICA 130 KIT 2BH	O ₂ /CO	300	ABS	Si-CA 130 Gas Analyzer Kit 2BH, includes two gas sensors (O ₂ , CO), 300 mm Probe rated to 800C with 3 m dual hose, ABS hard plastic carrying case, rubber holster, water trap with filter, charger with plug set, USB-C cable, quick start guide, calibration certificate
27511	SICA 130 KIT 3AS	O ₂ /CO/NO	180	Vinyl	Si-CA 130 Gas Analyzer Kit 3AS, includes three gas sensors (O ₂ , CO, NO), 180 mm Probe rated to 800C with 2 m dual hose, vinyl carrying case, rubber holster, water trap with filter, charger with plug set, USB-C cable, quick start guide, calibration certificate
27512	SICA 130 KIT 3AH	O ₂ /CO/NO	180	ABS	Si-CA 130 Gas Analyzer Kit 3AH, includes three gas sensors (O ₂ , CO, NO), 180 mm Probe rated to 800C with 2 m dual hose, ABS hard plastic carrying case, rubber holster, water trap with filter, charger with plug set, USB-C cable, quick start guide, calibration certificate
27522	SICA 2302	O ₂ /CO	300	ABS	Si-CA 230 Analyzer includes two gas sensors (O ₂ , CO), 300 mm Probe rated to 800C with 3 m dual hose, ABS hard plastic carrying case, rubber holster, water trap with filter, charger with plug set, USB-C cable, quick start guide, calibration certificate
27597	SICA 2303N	O ₂ /CO/NO	300	ABS	Si-CA 230 Analyzer includes three gas sensors (O ₂ , CO, NO), 300 mm Probe rated to 800C with 3 m dual hose, ABS hard plastic carrying case, rubber holster, water trap with filter, charger with plug set, USB-C cable, quick start guide, calibration certificate
27598	SICA 2303NL	O ₂ /CO/NO	300	ABS	Si-CA 230 Analyzer includes three gas sensors (O ₂ , CO, Low NO), 300 mm Probe rated to 800C with 3 m dual hose, ABS hard plastic carrying case, rubber holster, water trap with filter, charger with plug set, USB-C cable, quick start guide, calibration certificate
27599	SICA 2304ND	O ₂ /CO/NO/ NO ₂	300	ABS	Si-CA 230 Analyzer includes four gas sensors (O ₂ , CO, NO, NO ₂), 300 mm Probe rated to 800C with 3 m dual hose, ABS hard plastic carrying case, rubber holster, water trap with filter, charger with plug set, USB-C cable, quick start guide, calibration certificate
27600	SICA 2304NS	O ₂ /CO/NO/ SO ₂	300	ABS	Si-CA 230 Analyzer includes four gas sensors (O ₂ , CO, NO, SO ₂), 300 mm Probe rated to 800C with 3 m dual hose, ABS hard plastic carrying case, rubber holster, water trap with filter, charger with plug set, USB-C cable, quick start guide, calibration certificate

Accessories

Customize your own analyzer



Our combustion gas analysers are available in many different configurations, with a wide range of accessories to choose from. Contact our Customer Services team for more information about our kits and accessories, and for guidance on choosing the right options for your needs.

Reference	Type	Si-CA 030	Si-CA 130	Si-CA 230	
27532 (180 mm) 27533 (300 mm) 27534 (750 mm) 27535 (1 m) 27536 (1.5 m)	Probe sizes: 180 mm, 300 mm & 750 mm, and 1 m & 1.5 m	✓	✓	✓	
27936	180 mm flexible probe	✓	✓	✓	
27544	Draft probe	✓	✓	✓	
24646	Smart air temperature probe with 2 m cable	✓	✓	✓	
27865	Pt100 temperature probe	✓	✓	✓	
27547	Ambient CO probe	✓	✓	✓	
27548	Ambient CO ₂ probe	✓	✓	✓	
27546	Wireless printer	✓	✓	✓	
27537	Double tube extension, 3 m	✓	✓	✓	
27538	Differential pressure kit	✓	✓	✓	
11994	Smoke pump	✓	✓	✓	
26811	SCU for condensate removal	✓	✓	✓	

Applications

A range of products for all kinds of combustion equipment

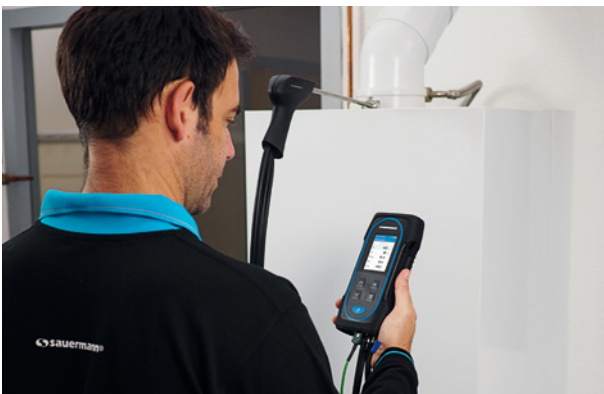

Digital manifold

The future of climate systems engineering

Vacuum / Temperature / Pressure

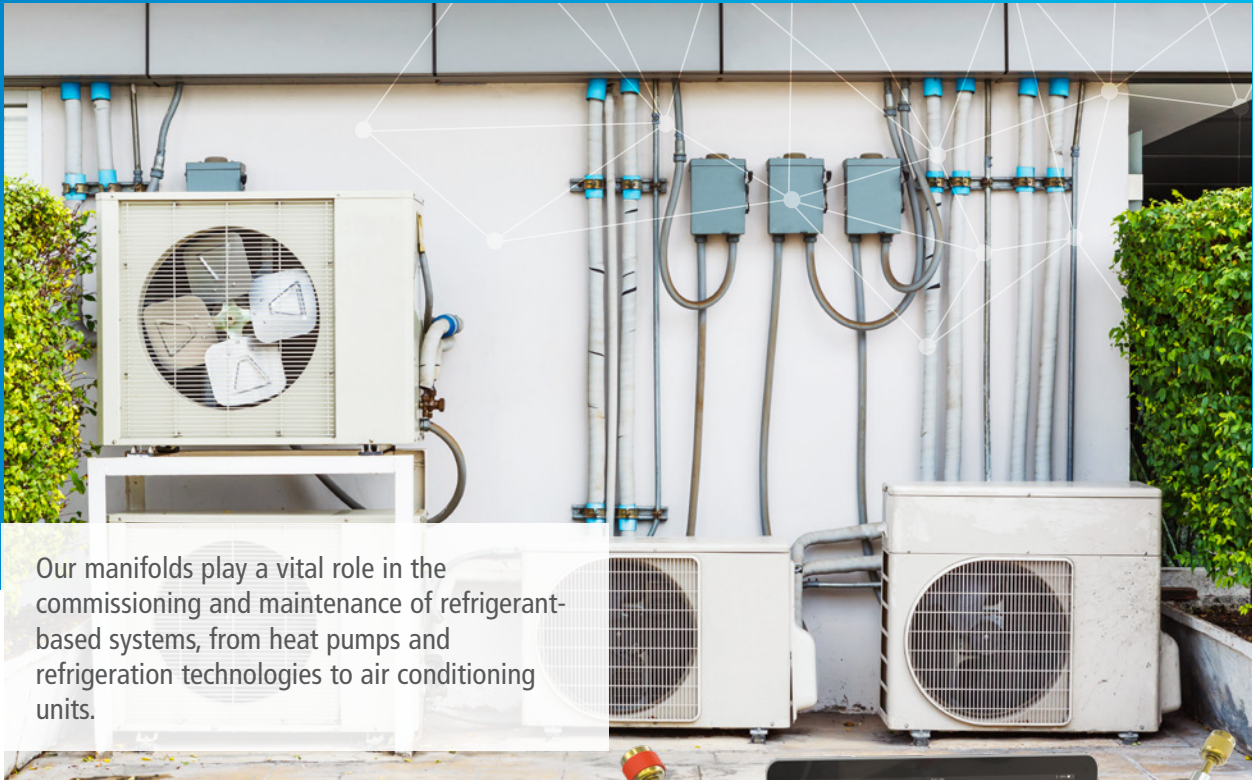

Our manifolds play a vital role in the commissioning and maintenance of refrigerant-based systems, from heat pumps and refrigeration technologies to air conditioning units.

In just a few short years, digital manifolds have become must-have instruments.

Their popularity stems from their ability to take quick, reliable measurements without the need for manual calculations.



Countries around the world are constantly tightening regulations on refrigerants in an effort to protect the planet. When it comes to complying with these rules, refrigeration engineers are on the front line. And the manifold is their instrument of choice.

Our digital manifold and vacuum probes combine the capabilities of multiple instruments into one, significantly reducing the size of engineers' toolboxes.

With their user-friendly design and ability to capture and report multiple parameters at once on a mobile app, these instruments are the all-in-one solution that HVACR specialists need.

Product overview

The ultimate all-in-one solution



TAKE COOLING UNIT MEASUREMENTS WITH THE SI-RM3



MEASURE EVACUATION WITH THE SI-RV3 VACUUM PROBE



PERFORM CHECKS WITH THE SI-RM13 COMBINED MANIFOLD

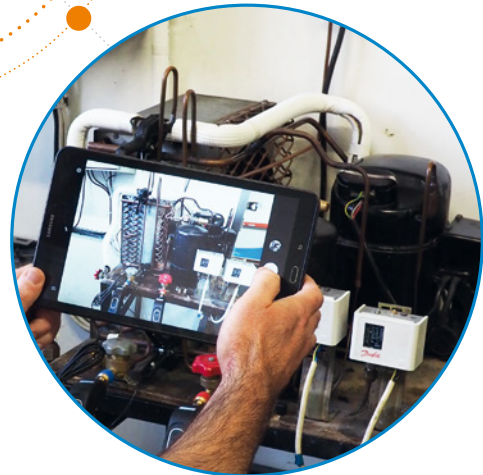

GENERATE REPORTS AND CAPTURE PHOTOS WITH THE MOBILE APP



Si-RM3

Smart wireless manifold probes with dual valves



Si-RV3

Smart wireless vacuum probe with dual valves



Si-RM13

Combined manifold with smart wireless probes and 2-channel by-pass



Si-Manifold

Mobile app

SMART PROBES



Air conditioning



Heating



Refrigeration

Si-RM3

Smart wireless manifold probes with dual valves



The new Si-RM3 digital manifold from Sauer mann provides installers with an ergonomic tool that fits into tight and compact places, an Si-Manifold app with wireless connectivity up to a range of 30 metres, and the ability to take a number of important readings in an all-in-one device.

It includes two pressure probes that precisely measure high side and low side pressure (from -1 to 60 bar) and instantly display the condensation/evaporation temperatures for up to 126 refrigerants on the Si-Manifold app, including new low global warming potential (GWP) and natural refrigerants.

Two temperature probes are used to accurately and simultaneously provide real-time superheat/subcooling calculations on the Si-Manifold app during the refrigeration process. A second connector allows for the charging and discharging of the refrigerant, and a built-in Schrader® core avoids leakages when you connect the hose.

Reference: 25555



Convenient design



Built-in Schrader® core



Accurate measurement of high and low pressure



Real-time superheat and subcooling calculations



Measurement during charging



Wireless connectivity (range up to 30 metres)



Air conditioning



Heating



Refrigeration



Accurate measurements of high and low pressure

Two pressure probes make this possible and provide condensation/evaporation temperatures.

Measurement during charging

A second connection allows charging of the system, and the built-in Schrader® core prevents leaks during connection/disconnects.



Real time superheat and subcooling calculations

Two temperature probes used with the Si-Manifold app make this possible and eliminate the need for manual calculations.

Technical data

	Si-RM1
Measuring range	-1 to 60 bar
Pressure sensing accuracy	±0.5% of full scale
Overload	65 bar
Burst pressure	150 bar
Battery life	250 h
Protection	IP54

	Si-RM2
Measuring range	-40 to 150 °C
Temperature accuracy	±1.3 °C
Temperature sensor	High-accuracy NTC thermistor
Pipe diameter	6 to 42 mm
Cable	2 m length
Protection	IP54

VACUUM MEASUREMENT



Air conditioning



Heating



Refrigeration

Si-RV3

Smart wireless vacuum probe with dual valves



Sauermann's Si-RV3 vacuum probe supports the quick, safe evacuation of refrigeration systems and heat pumps with highly accurate measurements.

It has an ergonomic design, an excellent Si-Manifold app with wireless connectivity up to a range of 30 metres, and a high-precision Pirani® sensor that provides deep vacuum measurements.

It also provides H₂O evaporation temperature on the Si-Manifold app in real time.

A second connector allows for the discharging of the refrigerant, and a built-in Schrader® core avoids any gas leakages when you connect the hose.

Reference: 25554



Ergonomic design
(45° angle)



Built-in Schrader®
core

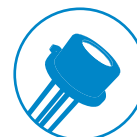

High accuracy
Pirani® sensor



Vacuum
measurement
during evacuation



Wireless connec-
tivity (range up to
30 metres)

Technical data

	Si-RV3
Measuring range	25,000 to 5 microns
Pressure sensing accuracy	±10% of the measured value ±10 microns
Overload	10 bar
Burst pressure	27.5 bar
Battery life	250 h
Protection	IP54

Download the Si-Manifold



COMBINED MANIFOLD



Air conditioning



Heating



Refrigeration

Si-RM13

Combined manifold with smart wireless probes and 2-channel by-pass

Sauermann's Si-RM13 combines the sturdiness of the analogue manifold with the Si-RM3's smart wireless manifold probes.

In this premium package, installers can take advantage of both devices.

It includes a traditional 2-channel analogue manifold body (by-pass type) with flexible hoses and a durable block made of anodized aluminium.

Installers can also utilize the numerous benefits from the smart wireless manifold probes for pressure and temperature measurements, as well as the Si-Manifold app.



Reference: 25558



Ergonomic design
(45° angle)



Built-in Schrader®
core



Measurement
during charging

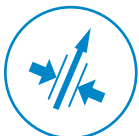

Accurate
measurement
of high and low
pressure



Real time
superheat and
subcooling
calculations



Wireless
connectivity (range
up to 30 metres)

Accessories for our manifold range



R410 gas connector

Reference: 25830

- Adaptation connector for R410 gas

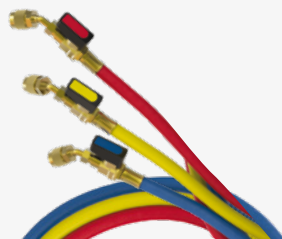

Flexible hoses

Reference: 25831

- Set of 3 flexible hoses
- 1 m length
- With stop valves



Velcro® temperature probe

Reference: 26140

- Temperature probe for large diameter pipes
- -40 to 150 °C



Extension cable

Reference: 26141

- 5 m length

Si-Manifold

All-in-one mobile app

The Si-Manifold app for iOS and Android provides wireless connectivity up to a range of 30 metres. It has the ability to store and update up to 126 refrigerants, including environmentally-friendly low global warming potential (GWP) and natural refrigerants.

Pressure, condensation/evaporation, pipe, and ambient temperatures are instantly provided on the Si-Manifold app, as are vacuumometer measurements. Providing these measurements eliminates the need for manual calculations.



Wireless connectivity
(range up to 30 metres)



Stores up to 126
refrigerants



Gauge, table and
graphic visualisations



Export reports



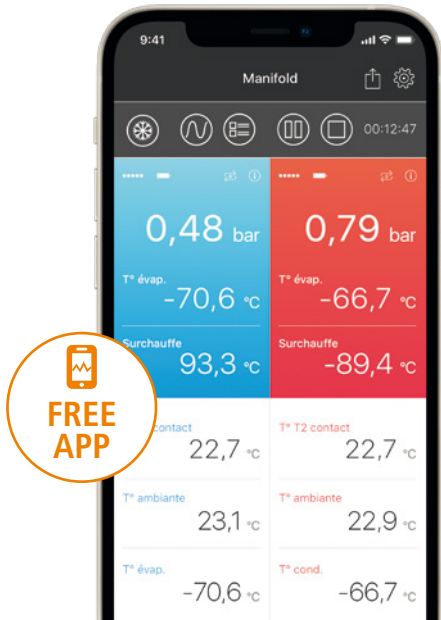

Everything you need in one app

- Data logging
- Tightness test
- Pressure target settings
- Vacuum function
- Heating and cooling functions
- etc.

User friendly

Easy-to-read digital gauge, table and graphic visualisations.

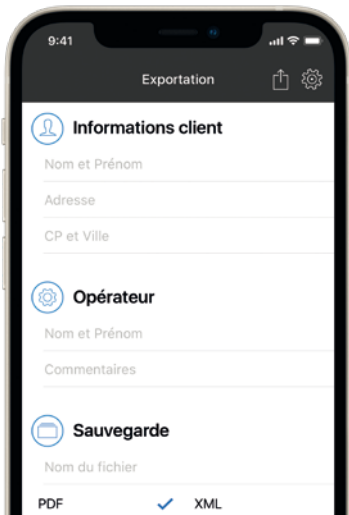
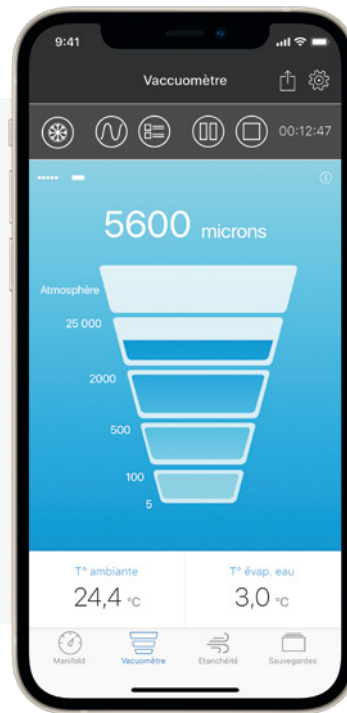

Save and export

- Export reports in PDF, CSV and XML formats for sending by email.
- Dataset can be saved and restarted. This function is very useful for long operations.



Download the Si-Manifold



CONDENSATE REMOVAL PUMPS

Detect. Remove. Protect.



Air conditioning



Heating



Refrigeration



MINI PUMPS



TANK PUMPS





Our condensate removal pumps feature a cutting-edge design that makes them global best-sellers.

Sauermann pumps are compatible with all condensate-generating systems, from domestic air conditioning units to powerful industrial-grade combustion boilers. Drawing on 45 years of experience in designing condensate removal pumps, our R&D team has developed a range of products that strike the perfect balance between versatility, flexibility, power and reliability.

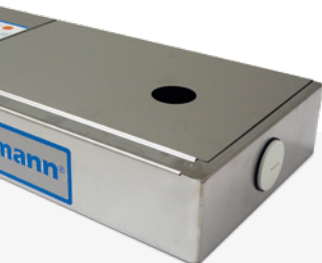

ACCESSORIES



Mini pumps

Exclusive technology, unmatched reliability

Detect and remove condensates from air conditioning units



Our mini condensate removal pumps help to prevent leaks and overflows in air conditioning units, protecting against the risk of water damage.



Our mini pumps feature an exclusive, patented electromagnetic piston technology that sets the gold standard for reliability and whisper-quiet operation.

Our range is compatible with all types of indoor and outdoor system, including all console, split and cassette-type air conditioning units. All our condensate removal pumps are discreet in design, quick and easy to maintain and built to last.



Some of the most reliable mini pumps money can buy



Whisper-quiet operation

Mini pumps

A solution for every application

Si-30
ABOVE-UNIT



Si-20
IN-UNIT

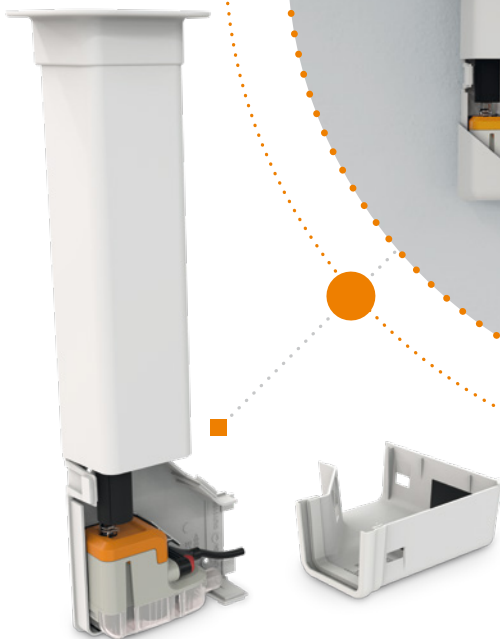





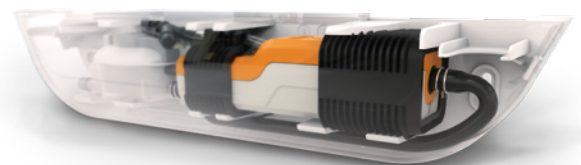



Delta Pack
UNDER-UNIT

Omega Pack
BESIDE-UNIT



Applications

Mini pumps

		Equipment						Location			
		Wall-mounted	Cassettes	Cabinet coolers	Floor-standing	Ducted unit	Suspended ceiling unit	Inside the unit	Wall-mounted (in trunking)	Wall-mounted (under the unit)	False ceiling
 Air conditioning											
	DELTA PACK	✓	-	-	-	-	-	-	✓	-	-
	Si-10 UNIVERS'L	-	✓	-	✓	✓	✓	✓	-	-	✓
	OMEGA PACK	✓	-	-	-	-	-	-	-	✓	-
	Si-20	✓	-	-	-	-	✓	✓	✓	-	-
	Si-30 Si-33	✓	-	-	✓	-	✓	-	-	-	✓
	Si-60	-	-	✓	✓	✓	-	✓	-	-	✓
	PE5000 PE5100 PE5200	✓	✓	-	-	-	-	-	-	-	✓

Actual flow rates

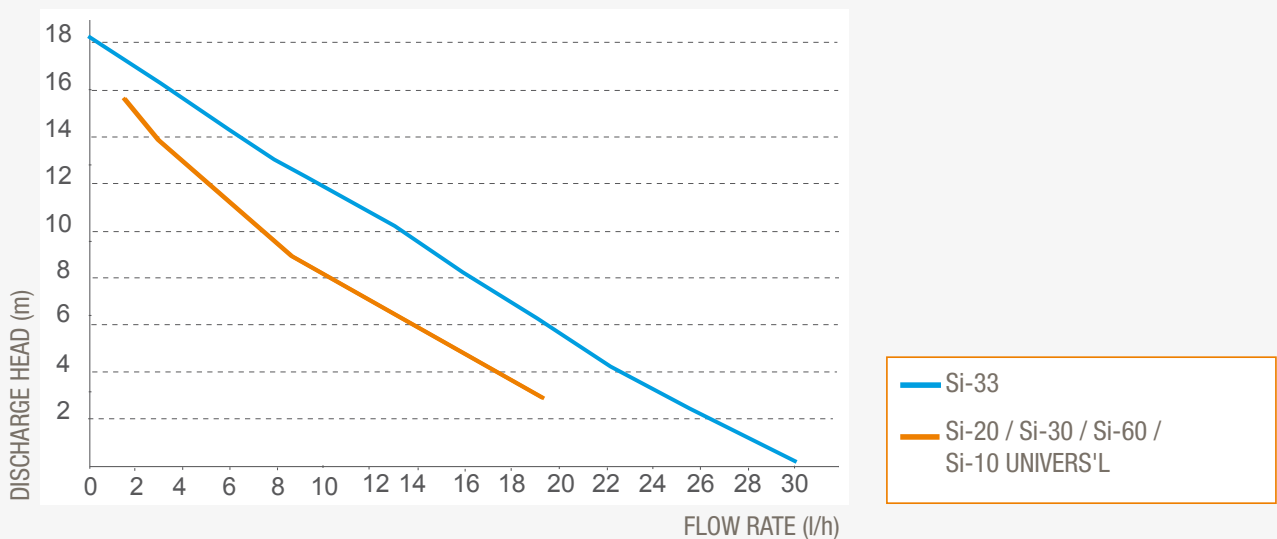

DELTA PACK

For wall-mounted air conditioning units



Air conditioning

The Delta Pack includes an elbow design that can be easily opened by hand by a simple finger push – no tool is needed. Its streamlined design complements wall-mounted air conditioning units. It includes the Si-10 Univers'L pump, which incorporates Sauermann's latest piston pump technology. The whisper-quiet pump also comes with insulating foam inside the corner piece and on the pre-installed drain pipe.



References:

80 x 60 mm cream RAL 9001: DP10CE06UN23

80 x 60 mm signal white RAL 9003: DP10CE05UN23



Easy to install

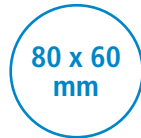

80 x 60 mm

Wide trunking



22 dBA

Whisper-quiet operation

DELTA PACK kit content

Si-10 Univers'L piston pump - Clear PVC tube (int. Ø 6 mm, L: 1 m, foam-insulated over 800 mm), fitted with a "drain safe device" connector - 1.5 m lockable plug-in power cable, with 2 power wires and 2 NC safety contact wires - 2-part elbow - Ceiling duct cover - Rubber elbow/split gasket - 650 mm rubber tube (int. Ø 15 mm) - Vent pipe - 6 screws and plugs for fixing duct and elbow - 4 double wire clamps Ø 16 mm, 1 double wire clamp Ø 6 mm - 750 mm duct, 80 x 60 mm.

SI-10 UNIVERS'L

Replacement pump for trunking corner pieces

For wall-mounted and floor-standing air conditioning units

The Si-10 Univers'L can replace the majority of corner piece-mounted pumps. It is also suitable as a replacement for Sauermann's Si-10 and SI 1082 models.

Reference: SI10CE03UN23



Universal



Technical data

	SI- 10 UNIVERS'L
Maximum flow rate	20 l/h
Maximum discharge head	10 m (flow rate = 4 l/h)
Pump sound level at 1 m	22 dBA
Detection levels (mm)	ON: 16, OFF: 11, Safety: 19
Mains supply	230 V ~ 50 Hz 14 W
Thermal protection	115 °C (auto-reset)
Protection	IPX4

*According to EN ISO 3744. Measured at LNE lab, pump operating with water, out of application.

OMEGA PACK



Air conditioning

Under-unit installation for wall-mounted air conditioners

The Omega Pack is designed for installation under a mini-split air conditioning unit. The onboard pump features proven reliability, while the pack comes with the full range of installation accessories including an anti-siphon device for hydraulic connection you can trust. The white box matches the colouring of the latest-generation wall-mounted air conditioning units.

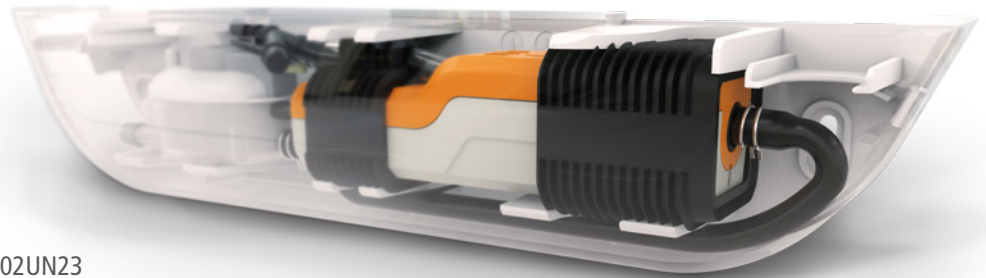

Reference:

Signal white RAL9003: OP20CE02UN23

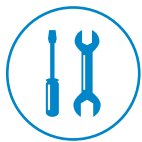

Easy to install



Ultra-reliable installation



Whisper-quiet operation

OMEGA PACK kit content

SI20CE01UN23 piston pump with anti-vibration rubber dampers - Clear PVC tubing (int. Ø 6 mm, L: 60 mm), fitted with a pre-mounted "drain safe device" connector - Detection unit with installation kit (90° rubber elbow, 3 double wire clamps, 3 tie wraps) - Power cable with NC safety contact wire - Shell (2-part: backplate and cover) - Screws and plugs for affixing backplate.

Si-20

Piston pump

The Si-20 sets a new record for its slim casing design, allowing it to easily fit inside any type of air conditioning unit or lineset cover. Offering best-in-class performance and sound levels for a mini pump of its size, this model delivers unmatched reliability.

Reference: SI20CE02UN23



Slim design



Technical data

	Si-20
Maximum flow rate	20 l/h
Maximum discharge head	10 m (flow rate = 4 l/h)
Pump sound level at 1 m*	19 dBA
Detection levels (mm)	ON: 16, OFF: 11, Safety: 19
Mains supply	30 V~ 50 Hz - 15 W
Thermal protection	115 °C (auto-reset)
Protection	IPX2

*According to EN ISO 3744. Measured at LNE lab, pump operating with water, out of application.



Si-30 / Si-33

Mini pumps with float detection

The pump mechanism inside the Si-30 and Si-33 models is specially designed by Sauermann to remove condensates produced by air conditioning units.

References:

Si-30: SI30CE02UN23

Si-33: SI33CE01UN23

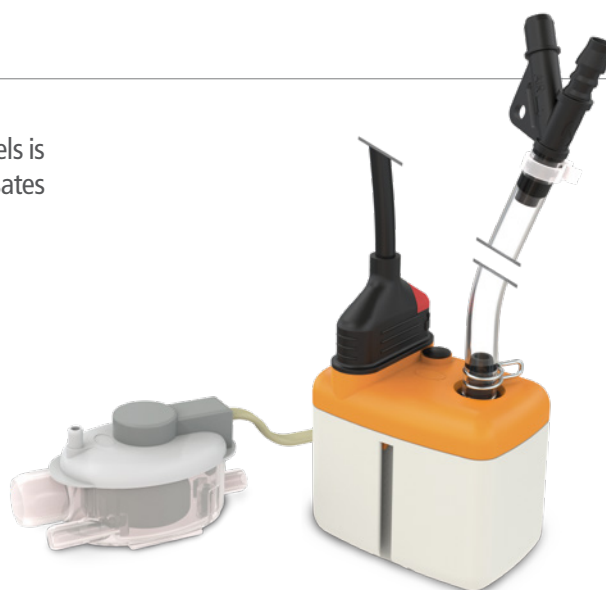

Patented Sauermann technology, specifically designed for removing condensates from air conditioning systems.



The pre-installed anti-siphon connector eliminates the risk of siphoning.



The mounting plate means the pump can be mounted on a wall, hung on the ceiling or affixed directly to a pipe.



Proven reliability



Ultra-reliable installation



Fits into any location

Technical data

	Si-30	Si-33
Maximum flow rate	20 l/h	30 l/h
Maximum suction height	3 m	3.3 m
Maximum discharge head	10 m (flow rate = 4 l/h)	> 13 m (flow rate = 8 l/h)
Pump sound level at 1 m*	20 dBA	34 dBA
Detection levels (mm)	ON: 16, OFF: 11, Safety: 19	
Mains supply	230 V ~ 50 Hz 14 W	230 V ~ 50 Hz 21 W
Protection	IP20	

*According to EN ISO 3744. Measured at LNE lab, pump operating with water, out of application.

Kit content

Pump - Clear PVC tubing (int. Ø 6 mm, L: 1 m), fitted with a pre-mounted "drain safe device" connector - Anti-vibration mounting bracket - 1.5 m lockable plug-in power cable with NC safety contact wires - 6 tie wraps - Detection unit (SI2958) with installation kit: rubber elbow 90° (int. Ø 15 mm, L: 60 mm), vent tube, mounting rail, adhesive.

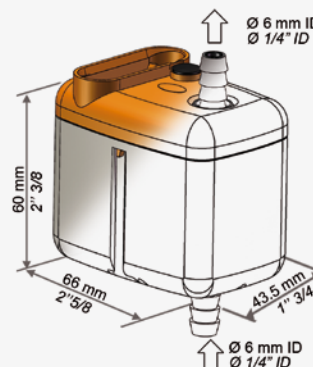

Si-60



Air conditioning

For ducted air conditioning systems and cabinet coolers

The Si-60 pump with built-in tank (0.37 L) is suitable for air conditioning units up to 20 kW. This pump is equipped with Sauermann's piston pump technology specifically designed for removing condensates, and with a reliable anti-clogging detection system for use in all types of environment.

Its compact, sleek design makes it a breeze to handle, while the wide range of hydraulic connectors means this pump is easy to install in any location.

Reference: SI60CE01UN23



Twist-lock power cable for secure connection.



Reliable anti-clogging detection system for use in all types of environment.



Top and bottom condensate inlet. Can also be installed directly in the tray.



Lockable cable



Innovative detection



Fits into any location

Kit content

Pump - Lockable plug-in 1.5 m cable with NC safety contact wires - Installation kit: adapter (int. Ø 15-20-24-32-40 mm), 90° rubber connector (int. Ø 15 mm, L: 60 mm), 90° plastic connector for int. Ø 6 mm flexible tube, 1 2.5 × 100 mm tie wrap.

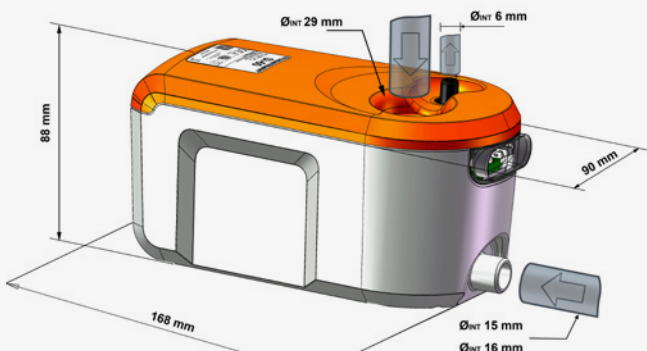

Technical data

	Si-60
Maximum flow rate	20 l/h
Maximum discharge head	10 m (flow rate = 4 l/h)
Pump sound level at 1 m*	< 38 dBA
Detection levels (mm)	ON: 28, OFF: 24, Safety: 35
Mains supply	230 V ~ 50 Hz 14 W
Protection	IPX4

*According to EN ISO 3744. Measured at LNE lab, pump operating with water, out of application.

Suitable as a replacement for an EE 1650 model.



PE 5000 / PE 5100

PE 5200

Peristaltic pumps for wall-mounted split units, suspended ceiling units, ducted units and cabinet coolers up to 8 kW

These peristaltic pumps are among the most compact models money can buy. They combine whisper-quiet operation with practical and clever design features: the detachable and replaceable head (PE 5001) and tubes (PE 5002) reduce maintenance work and cost.

The PE 5000 is controlled by a signal from the air conditioning compressor.

The PE 5100 is equipped with two temperature probes.

The PE 5200 is controlled by a remote detection unit fitted with a 3-level float (on/off/alarm).



PE 5000



PE 5100



PE 5200

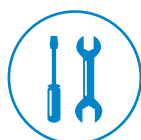

Easy maintenance



3 detection systems

References:

PE5000: PE5000SIUN23

PE5100: PE5100SIUN23

PE5200: PE5200SIUN23

Kit contents

Common items included in installation kit: Pump - Cable (1.7 m) including 2 power supply wires- Sliding plastic bracket - Adapter (Ø 15 - 6 mm), pale yellow rubber (35 mm, Ø 15 mm).

Additional items in PE 5100 kit: 3.5 m cable for 2 thermal probes (ambient air cap and cold air cap).

Additional items in PE 5200 kit: Detection unit with 3-level float - Power supply cable (1.5 m) with NC safety contact - Detection unit installation kit: vent tube (75 mm, Ø 4 x 6 mm), self-adhesive mounting rail.

Removable and replaceable heads and tubes:

PE5002: replacement tube
PE5001: replacement tube

Technical data

	PE 5000 / PE 5100 / PE 5200
Maximum flow rate	6 l/h
Maximum discharge head	12 m
Pump sound level at 1 m*	≤ 30 dBA
Detection levels PE 5200 (mm)	ON: 16, OFF: 11, Safety: 19
Mains supply	230 V~ 50/60 Hz -75 W
Protection	IPX4

*According to EN ISO 3744. Measured at LNE lab, pump operating with water, out of application.

Tank pumps

Powerful and built to last

For managing large volumes of condensate



Tank pumps are intended for large heating, refrigeration and air conditioning systems, such as supermarket refrigerated display cabinets, central boilers and multi-cassette air conditioners.











Sauermann tank pumps are built for power and durability, so they can withstand even the toughest conditions.

Our tank pumps are specially designed for high-powered air conditioning, heating and refrigeration systems that generate large volumes of condensate. They're also built to handle hot, acidic, biofilm-heavy and other special types of condensate.

Applications

Keep complex systems protected

		Capacity		Equipment							Location					
				 Air-cond.		 Heating					 Refrig.					
		Domestic use	Intensive use	Domestic air conditioning	Cassette Ducted unit Multi-cassette system	Domestic gas-fired condensing boiler	Domestic oil-fired condensing boiler	Dehumidifier	Small refrigerated display cabinet	Large refrigerated display cabinet	Floor-standing	Wall-mounted	Under-unit	In-unit		
	SI-83	✓	-	✓	-	✓	-	-	-	-	✓	✓	✓	-		
	SI-82	-	✓	-	✓	✓	-	✓	✓	-	✓	✓	-	-		
	SI 1805	-	✓	-	✓	✓	-	-	✓	-	-	-	✓	-		
	SI 1830	-	✓	-	-	-	✓	-	-	-	-	✓	✓	✓		
	SI 1850	-	✓	-	✓	✓	-	-	-	✓	✓	-	-	-		
	SI-1931	-	✓	-	-	-	-	-	-	✓	✓	-	✓	-		



Si-82



Air conditioning



Heating



Refrigeration

For cassette, multi-cassette and ducted air conditioning systems, dehumidifiers, small refrigerated display cabinets and gas-fired condensing boilers

The Si-82 is designed for easy installation in any situation: floor-standing, wall-mounted or hanging on the ceiling. The pump can remove up to 500 litres per hour and can withstand acidic and charged condensates, making it ideal for air conditioning and refrigeration systems.

References:

PACK 1: SI82CE01UN23

PACK 2 + pH Safe: SI82CE03UN23



Removable cable for easy installation and maintenance.



Non-return valve for easily connecting Ø 10 mm pipes. Four condensate inlets with caps.



Mounting points for floor-standing, ceiling and wall-mounted installation. Reversible tray.



Quick power connection



Easy hydraulic connection



Fits into any location

Kit contents

PACK 1: One-piece centrifugal pump - Tank (2 l) – Built-in non-return valve (10 mm ext. Ø) - Plug-in cable: power (2 m, European plug) and NC safety contact (1.5 m, bare ends) - Straight connector (ext. Ø 10 mm / ext. Ø 6 mm) - 2 screws + 2 plugs.

PACK 2: One-piece centrifugal pump with tank (2 l) - Plug-in cable: power (2 m, European plug) and NC safety contact (1.5 m, bare ends) - Clear PVC tube: int. Ø 10 mm, 5 m - Flexible adapter (int. Ø 15-20-24-32-40 mm) - 2 screws + 2 plugs. The PACK 2 + pH Safe option includes one pH Safe 1 neutralization cartridge.

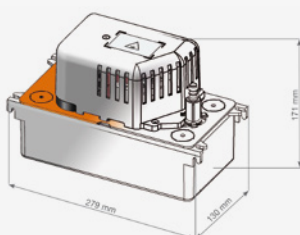

Technical data

	Si-82
Maximum flow rate	500 l/h
Maximum discharge head	5 m (flow rate = 50 l/h)
Pump sound level at 1 m*	< 45 dBA
Detection levels (mm)	ON: 53, OFF: 42, Safety: 64
Mains supply	230 V ~ 50/60 Hz - 70 W
Protection	IP20

*According to EN ISO 3744. Measured at LNE lab, pump operating with water, out of application. Suitable as a replacement for the SI 1800 and SI 1805 models.

Si-83



Air conditioning



Heating

For domestic air conditioning systems and domestic gas-fired condensing boilers

The Si-83 is more compact than any other pump in its class. With five condensate inlet options and a slimline profile (just 129 mm), it's ideal for installing under domestic gas-fired condensing boilers (up to 40 kW). The SI83CE43UN23 model comes with a neutralization cartridge that effectively neutralizes the acidic condensates produced by domestic gas-fired condensing boilers. The versatile Si-83 pump is also perfect for domestic air conditioning systems (up to 20 kW).

The pump even comes with its very own smartphone app – the Si-83 MobileApp – that makes installation both simple and intuitive.



References:

PACK 1: SI83CE01UN23

PACK 2: SI83CE42UN23

Pack 2 + pH Safe: SI83CE43UN23



Easier to install than anything in its class



Neutralization



Si-83 MobileApp

Kit contents

PACK 1: Centrifugal pump with 2 l tank - Removable non-return valve, ext. Ø 10 mm - 1.8 m power cable, plug - Built-in safety switch, 1 m wires, plug, NC contact - 2 screws + 2 plugs - Straight connector and tie wrap for 6 mm int. Ø tubes.

PACK 2: Centrifugal pump with 2 l tank - Removable non-return valve, ext. Ø 10 mm - 1.8 m power cable, plug - Built-in safety switch, 1 m wires, bare ends, NO contact in Pack 2 - 2 screws + 2 plugs - Multi adapter to be used for Ø 15/17 - 20 - 24/25 - 32 - 40 mm tubes - Clear PVC tubing, int. Ø 10 mm, 5 m. The PACK 2 + pH Safe option includes one pH Safe 1 neutralization cartridge.

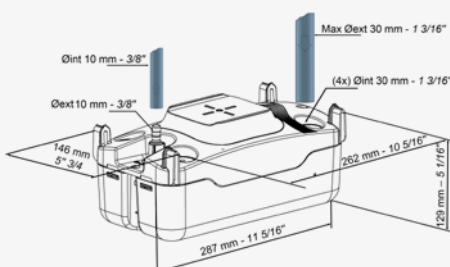

Technical data

	Si-83
Maximum discharge head	5,4 m (65 l/h)
Maximum pressure (flow rate 0)	5,7 m
Pump sound level at 1 m*	<45 dBA
Operating cycle	7%, non-continuous
Mains supply	230 V~ 50 Hz - 115 W - 1.4 A
Protection	IP44

*According to EN ISO 3744. Measured at LNE lab, pump operating with water, out of application.

SI 1805



Air conditioning



Heating

For cassette, multi-cassette and ducted air conditioning systems, small refrigerated display cabinets and gas-fired condensing boilers

The SI 1805 is designed for easy installation in any conditions.

The pump can remove up to 500 litres per hour, making it ideal for air conditioning and refrigeration systems.

The robust SI 1805 pump easily withstands the charged, high-temperature and acidic (pH > 3.4) condensates produced by gas-fired condensing boilers.

Reference:

SI1805SIUN23



High capacity



Compact



Ultra-reliable
Can be installed
anywhere

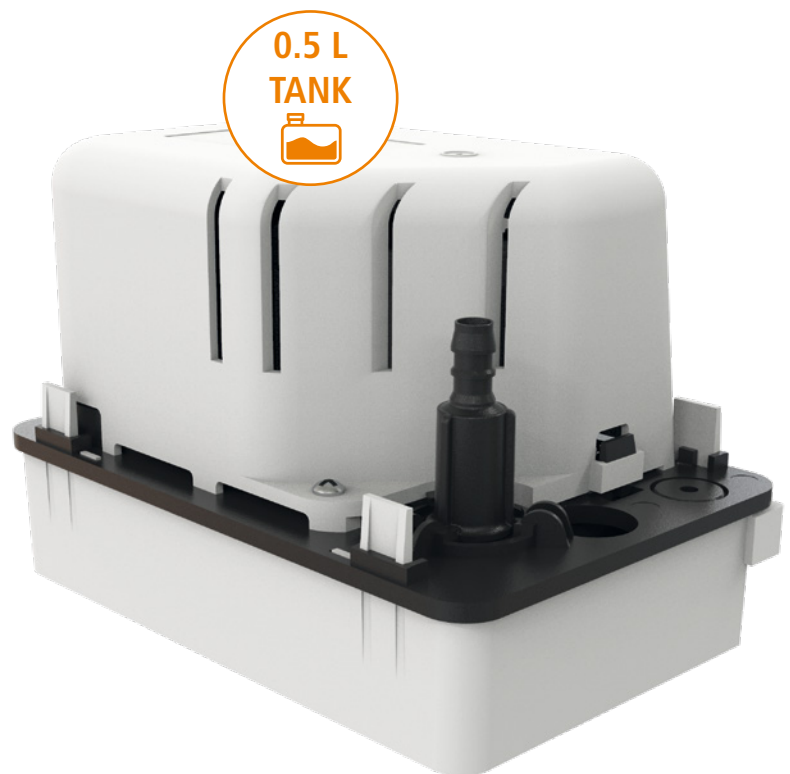

Kit content

Pump - 2 screws + 2 plugs - 2 m power cable with European plug, safety switch cord: 1 m, 2 wires (NC contact).

Dimensions

L 195 x W 130 x H 132 mm

Technical data

	SI 1805
Maximum flow rate	500 l/h
Maximum discharge head	5,4m
Pump sound level at 1 m*	≤ 47 dBA
Detection levels (mm)	ON: 27, OFF: 21, Safety: 32
Mains supply	230 V~ 50/60 Hz -90 W
Protection	IP20

*According to EN ISO 3744. Measured at LNE lab, pump operating with water, out of application.

SI-1830 / SI 1850



Air conditioning



Heating



Refrigeration

For oil-fired condensing boilers

The SI-1830 is built for use in the toughest conditions. It easily withstands the charged (e.g. oil residues), hot and highly acidic condensates produced by oil-fired condensing boilers.

Its watertight case protects the motor from acidic fumes and water splashes.

The SI-1830 can also be installed without its tank, directly in the condensate tray.

The 3.8 litre tank means the SI 1850 can remove up to 1,100 litres per hour, making it suitable for high-powered air conditioning and refrigeration systems. The robust SI 1850 pump easily withstands the charged, high-temperature condensates produced by gas-fired condensing boilers.

References:

SI1830SCUN23

SI1850SIUN23



High performance



Rugged design



Kit contents

SI-1830: Pump with 0.5 l tank - 1.5 m power cable with European plug, safety switch cord: 1 m, 2 wires (NC contact) - Installation kit: 2 screws + 2 plugs, clear PVC tube (int. Ø 10 mm, 5 m), flexible adapter (Ø 15-24-32-40 mm).

SI 1850: One-piece centrifugal pump with 3.8 l tank - Built-in non-return valve, ext. Ø 10 mm.

Dimensions

SI-1830: L 190 x W 80 x H 100 mm

SI 1850: L 305 x W 152 x H 257 mm

Technical data

	SI 1830	SI 1850
Maximum flow rate	400 l/h	1 100 l/h
Maximum discharge head	3,7 m	10 m
Pump sound level at 1 m*	≤ 43 dBA	≤ 66 dBA
Detection levels (mm)	ON: 32, OFF: 25, Safety: 39	ON: 81, OFF: 48, Safety: 101
Mains supply	230 V~ 50/60 Hz 75 W	230 V~ 50 Hz 200 W
Protection	IPX4	IP20

*According to EN ISO 3744. Measured at LNE lab, pump operating with water, out of application.



SI-2052

Maintenance kit for cassette-type systems with centrifugal pump

The SI 2052 pump can be used as a replacement for some Sauermann pumps installed in series on cassette-type and ceiling-mounted air conditioning units up to 20 kW. The centrifugal technology inside this pump is specially designed to remove condensates quietly and continuously in any type of environment. The single-level detection unit can be used as a safety contact (NC) to cut off the air conditioning system compressor or solenoid valve automatically.



Reference: SI2052SIUN23



Compatible with most market-standard models



Wire-to-wire connector

Kit content

Centrifugal pump - 250 mm overmoulded cable - 850 mm cable with wire-to-wire connector - High level safety detection unit (DET01550, 900 mm cable) - Stainless steel screw for detection unit.

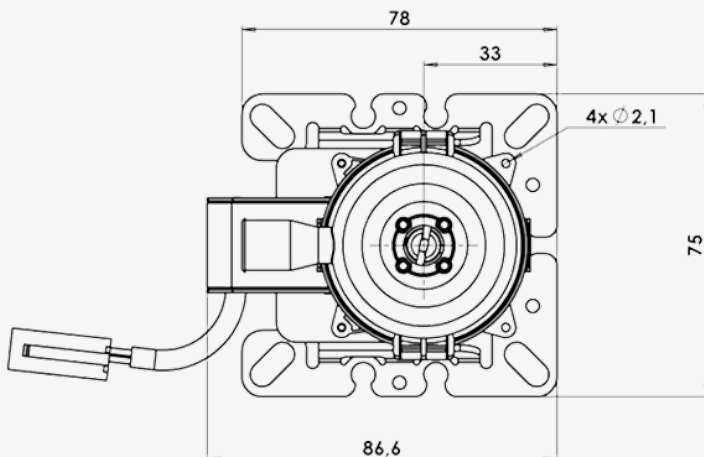

Technical data

	SI 2052
Maximum flow rate	100 l/h at 200 mm
Maximum discharge head	0.9 m (24l/h)
Pump sound level at 1 m*	≤ 30 dBA
Detection levels (mm)	Safety: 18
Consommation électrique	230 V ~ 50/60 Hz - 14 W

*According to EN ISO 3744. Measured at LNE lab, pump operating with water, out of application.

Si-1931

Dairy pump for refrigerated display cabinets

Specially designed to handle condensate from supermarket refrigerated display cabinets, the Si-1931 pump also offers a proven solution against the formation of biofilm with its Gel-clear tablet.

The compact design of the pump facilitates installation under low-slung display cabinets.

- Ultra-flat profile: 80 mm high.
- Three inlet points: top, right or left.
- Keeps the condensate drain clear.
- Reduces water leaks by more than 90%.
- Prevents the formation of biofilm and extends pump life.

Reference:

SI1931CE01EU23



Reduced operation costs



Easy installation – easy maintenance



Gel-clear tablet: the proven anti-biofilm solution



Kit content

Dairy pump with a power cable (NO safety contact) and a 13 mm outlet - Outlet adapter, Ø 10 mm - Hard plastic inlet adapter, Ø 40 mm - 2 Gel-clear tablets.

Technical data

	Si-1931
Flow rate at 6 m	700 l/h
Maximum discharge head	24.6 m
Protection	IP20
Pump dimensions	L 610 x W 235 x H 80 mm
Tank volume	6.5 l

Accessories

Accessories suitable for all makes and applications

Pipes and fittings (Ø 6 and Ø 10 mm)



Double wire clamp

To ensure safe connection between connectors and a clear PVC tube.

Dimension	Qty per bag	Ref.
Ø 6 mm	25	ACC00912
Ø 10 mm	25	ACC00913

Double wire clamp for braided tube

To ensure safe connection between connectors and a braided PVC tube.

Dimension	Qty per bag	Ref.
Ø 6 mm	25	ACC00916
Ø 10 mm	25	ACC00917



Straight connector

To connect two Ø 6 mm (1/4") or Ø 10 mm (3/8") clear PVC tubes.

Dimension	Qty per bag	Ref.
Ø 6 mm	5	ACC00900
Ø 10 mm	5	ACC00901



Elbow connector

To connect two Ø 6 mm (1/4") or Ø 10 mm (3/8") clear PVC tubes.

Dimension	Qty per bag	Ref.
Ø 6 mm	5	ACC00904
Ø 10 mm	5	ACC00905



"T" reducer multi diameter

To connect three PVC tubes, one Ø 6 mm int. (1/4") and two Ø 10 mm int. (3/8").

Dimension	Qty per bag	Ref.
Ø 6 to 2x Ø 10 mm	5	ACC00907



Self-sealing drainage fitting

Used to connect a PVC tube to the exhaust pipe.

The self-sealing fitting makes the connection reliable.

Dimension	Qty per bag	Ref.
Ø 6 mm	5	ACC00919
Ø 10 mm	5	ACC00920



"T" connector

To connect three Ø 6 mm (1/4") or Ø 10 mm (3/8") clear PVC tubes.

Dimension	Qty per bag	Ref.
Ø 6 mm	5	ACC00902
Ø 10 mm	5	ACC00903



Reducer connector

Reduces diameter of tubing coming out of a tank pump from Ø 10 mm (3/8") to Ø 6 mm (1/4").

Dimension	Qty per bag	Ref.
Ø 6 to Ø 10 mm	5	ACC00906



Rubber reducing adapter

To connect a Ø 20 mm (1 1/2") PVC tube to a Ø 10 mm (3/8") PVC tube.

Dimension	Qty per bag	Ref.
Ø 20 to Ø 10 mm	3	ACC00908



Non-return valve

In-line non-return valve for Ø 6 mm (1/4") PVC tubes.

Dimension	Qty per bag	Ref.
Ø 6 mm	5	ACC00924



Clear PVC tubing

Clear PVC tubing for connecting the pump to the discharge outlet.

Dimension	Qty per bag	Ref.
Ø 6 mm - 5 m	1	ACC00909
Ø 6 mm - 50 m	1	ACC00910
Ø 10 mm - 25 m	1	ACC00911



Braided tube

Clear PVC braided tubing for connecting the pump to the discharge outlet.

Dimension	Qty per bag	Ref.
Ø 6 mm - 50 m	1	ACC00914
Ø 10 mm - 25 m	1	ACC00915



Glued fitting

This fitting is perfect for connecting clear tubing to new/first PVC tubing installations with glue recommended on the PVC end.

Dimension	Qty per bag	Ref.
Ø 6 or Ø 10 mm	1	ACC00921



Drain safe device

Ensures there is no siphoning effect and that the pump will not run dry and stop working.

Dimension	Qty per bag	Ref.
Ø 6 mm	5	ACC00922
Ø 10 mm	5	ACC00923



Detection mini pumps



Double wire clamp

With a diameter of Ø 16 mm (5/8"), it is used for tubes coming out of the condensate tray.

Dimension	Qty per bag	Ref.
Ø 16 mm	25	ACC00930



Elbow rubber adapter

Its length (142 mm, 6"), width (35 mm, 1 9/32") and diameter (16 mm, 5/8") make it easy to install.

Dimension	Qty per bag	Ref.
Ø 16 mm - 35mm x 142mm	3	ACC00934



Reducing adapter

To reduce diameter between the AC condensate tank and the detection unit inlet.

Dimension	Qty per bag	Ref.
Ø 32 to Ø 16 mm	3	ACC00926



Multi diameter reducing adapter

To connect tubes of Ø 6 mm (1/4") or Ø 10 mm (3/8") to tubes of Ø 12 mm (1/2") or 16 mm (5/8").

Dimension	Qty per bag	Ref.
Ø 6 to Ø 10, 12, 16 mm	5	ACC00927



Straight connector

To connect two Ø 16 mm (5/8") rubber tubes together.

Dimension	Qty per bag	Ref.
Ø 16 mm	5	ACC00928



Drain tray connector

To facilitate the installation of the detection unit of a mini pump detection unit into a mini split.

Dimension	Qty per bag	Ref.
Ø 16 mm	3	ACC00929



Rubber extension

For connecting the AC condensate tank outlet to a mini pump detection unit. Ø 16 mm (5/8").

Dimension	Qty per bag	Ref.
Ø 16 mm - L 600 mm	1	ACC00931



90° rubber elbow adapter

For connecting the AC condensate tank outlet to a mini pump detection unit.

Dimension	Qty per bag	Ref.
Ø 16 mm - 35mm x 35mm	3	ACC00932



"S" type rubber hose

To connect the AC condensate tank outlet to a mini pump detection unit.

Dimension	Qty per bag	Ref.
Ø 16 mm - L 55 mm	3	ACC00933



Extension cable for use with the Si-2958 detection unit

To increase the length between the detection unit and the pump – for use with the Si-2958 detection unit.

Dimension	Qty per bag	Ref.
3 m	1	ACC00942
5 m	1	ACC00943

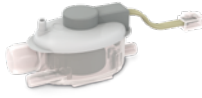

Si-2958 detection unit

Replacement detection unit for Si-30, Si-33 and PE 5200 pumps.

Dimension	Qty per bag	Ref.
-	1	SI2958



Replacement floats

for the detection blocks of bi-block piston pumps (A) and monobloc piston pumps (B).

Compatible	Qty per bag	Ref.
SI2958 detection unit	5	ACC00946
Si-10 Univers'L	5	ACC00947



Centrifugal pumps



Push fit fitting tank connector

To channel condensate through the side of the tank. For 32 mm (1" 1/4) tubes

Dimension	Qty per bag	Ref.
Ø 32 mm	1	ACC00940



Anti-biofilm



Gel-clear tablets

Replacement tablets for Si-1931 pumps fitted to refrigerated display cabinets.

Dimension	Qty per bag	Ref.
-	1	SPSI93T1
-	10	SPSI93T10



Neutralization



Rubber multi diameter condensate inlet adapter

Multi diameter adapter to be used for a range of different tubes.

Dimension	Qty per bag	Ref.
Ø 15 to Ø 20, 24, 32, 40 mm	3	ACC00939



pH Safe 1

Neutralization cartridge for use with the Si-82 and Si-83 pumps to effectively neutralize the condensates produced by gas-fired condensing boilers. Capable of neutralizing up to 800 litres of acidic condensates per year at pH3.

Dimension	Qty per bag	Ref.
-	1	PH0100SIUN23



Rubber condensate inlet adapter

To channel condensate into a tank pump through a PVC tube.

Dimension	Qty per bag	Ref.
Ø 25 to Ø 20 mm	3	ACC00936
Ø 32 to Ø 20 mm	3	ACC00937
Ø 40 to Ø 20 mm	3	ACC00938



pH Safe 2

For neutralizing the condensates produced by gas-fired condensing boilers. Capable of neutralizing up to 6 litres of acidic condensates per hour at pH3.

Dimension	Qty per bag	Ref.
-	1	PH02CE01UN00



Miscellaneous



Non-return valve

Non-return valve for use with Sauermann centrifugal pumps. For Ø 10 mm (3/8") tubes.

Dimension	Qty per bag	Ref.
Ø 10 mm	3	ACC00925



Priming squeeze bottle

After the installation or the maintenance of a condensate removal pump, this bottle helps start or clean the system.

Dimension	Qty per bag	Ref.
-	1	ACC00944



Sauermann online

All our products



Detailed specifications and photos of all our measurement instrument and pump ranges.

Resource centre



Get all the resources you need, from technical data sheets, manuals and catalogues, to software and apps.

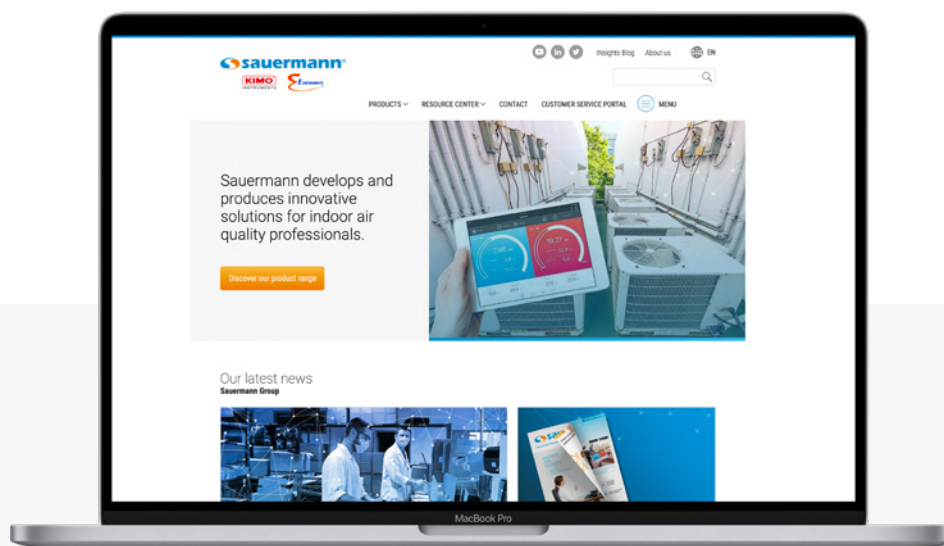

sauermanngroup.com

Professional solutions for condensate management and indoor air quality measurement

INsights

Case studies, useful information and practical advice for HVACR and indoor air quality professionals.

sauer mann group.com/insights

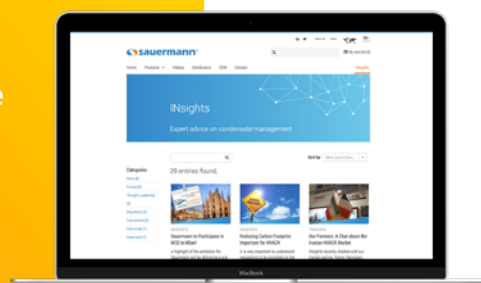

Sauer mann on YouTube

Head to our YouTube channel for tutorials, webinars and product guides.

youtube.com/sauer mann group

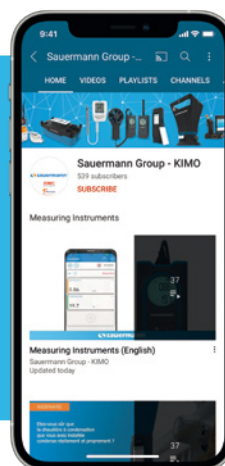

For more information, visit sauer mann group.com



View this catalogue online



Sauer mann Industrie S.A.S
Route de F erolles
77173 Chevry-Cossigny - France

+33 (0)1 60 06 69 25
services@sauer mann group.com