

CP 110

Quick Start Guide

- EN
- FR
- ES
- IT
- DE

Quick Start Guide



Differential pressure transmitter



Ranges from -100/+100 Pa to
-2000/+2000 mbar (according to model)



Configurable intermediary
ranges

Features

- 0-10 V or 4-20 mA output, active, power supply 24 Vac/Vdc (3-4 wires) or 4-20 mA output, passive loop, power supply from 16 to 30 Vdc (2 wires)
- ABS V0 housing, IP65, with or without display
- "1/4 turn" system mounting with wall-mount plate
- Housing with simplified mounting system
- Solenoid valve for auto-calibration (only on CP 111 model)

General features

Output / Supply	Active sensor 0-10 V or 4-20 mA (alim. 24 Vac/Vdc $\pm 10\%$), 3-4 wires Passive loop 4-20 mA (power supply 16/30 Vdc), 2 wires Common mode voltage <30 VAC Maximum load: 500 Ω (4-20 mA) / minimum load: 1 K Ω (0-10 V)
Consumption	CP 111: 3 VA (0-10 V) or 3 VA (4-20 mA) CP112, CP113, CP 114, CP 115: 2 VA (0-10 V) or 0.6 VA (4-20 mA)
European directives	2014/30/EU EMC; 2014/35/EU Low Voltage; 2011/65/EU RoHS II; 2012/19/EU WEEE
Electrical connection	Screw terminal block for cables from 0.05 to 2.5 mm ² or from 30 to 14 AWG Carried out according to the code of good practice
PC Communication	USB-mini DIN cable
Environnement	Air and neutral gases
Response time	1/e (63%) 0.3 s
Zero setting	Manual autozero with push-button; self-calibration by solenoid valve (CP 111 only)
Type of fluid	Air and neutral gases
Conditions of use (°C/%RH/m)	From 0 to +50 °C. In non-condensing condition. From 0 to 2000 m
Storage temperature	From -10 to +70 °C

*All the accuracies indicated in this technical datasheet were stated in laboratory conditions, and can be guaranteed for measurements carried out in the same conditions, or carried out with calibration compensation.

Technical specifications

	CP 111	CP 112	CP 113	CP 114	CP 115
Measuring ranges	-100/+100 Pa	-1000/+1000 Pa	-10000/+10000 Pa	-500/+500 mbar	-2000/+2000 mbar
Measurement units	Pa, mmH ₂ O, inWG, mmHG, daPa, kPa, hPa, mbar	Pa, mmH ₂ O, inWG, mmHG, daPa, kPa, hPa, mbar	Pa, mmH ₂ O, inWG, mmHG, daPa, kPa, hPa, mbar	mbar, inWG, mmHG, PSI, mmH ₂ O, daPa, hPa, kPa	mbar, inWG, mmHG, PSI, mmH ₂ O, daPa, hPa, kPa
Accuracy*	±1% of reading ±2 Pa	±1.5% of reading ±3 Pa	±1.5% of reading ±30 Pa	±1.5% of reading ±3 mbar	±1.5% of reading ±3 mbar
Resolution	1 Pa; 0.1 mmH ₂ O; 0.01 mbar; 0.01 inWG; 0.01 mmHG; 0.1 daPa; 0.001 kPa; 0.01 hPa	1 Pa; 0.1 mmH ₂ O; 0.01 mbar; 0.01 inWG; 0.01 mmHG; 0.1 daPa; 0.001 kPa; 0.01 hPa	1 Pa; 0.1 mmH ₂ O; 0.01 mbar; 0.01 inWG; 0.01 mmHG; 0.1 daPa; 0.01 kPa; 0.01 hPa	1 mbar; 0.1 inWG; 1 mmHG; 1 mmH ₂ O; 1 hPa; 10 daPa; 0.1 kPa; 0.1 PSI	1 mbar; 0.1 inWG; 1 mmHG; 1 mmH ₂ O; 1 hPa; 10 daPa; 0.1 kPa; 0.1 PSI
Overpressure tolerated	21 000 Pa	21 000 Pa	69 000 Pa	1400 mbar	4100 mbar

Features of the housing

Material	ABS V0 as per UL94
Protection	IP65
Display	LCD 10 digits. Dimensions: 50 x 17 mm Height of digits: values: 10 mm; units: 5 mm
Connections	Ribbed, Ø 6.2 mm
Cable gland	For cables Ø 8 mm maximum
Weight	143 g

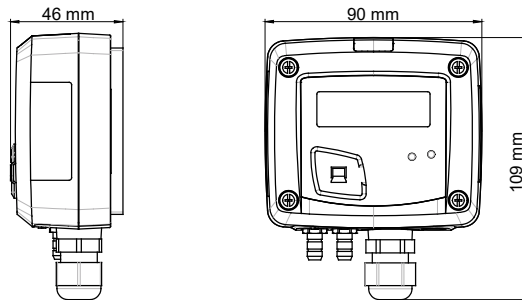

Symbols used

For your safety and in order to avoid any damage of the device, please follow the procedure described in this document and read carefully the notes preceded by the following symbol:



The following symbol will also be used in this document, please read carefully the information notes indicated after this symbol:



Connections

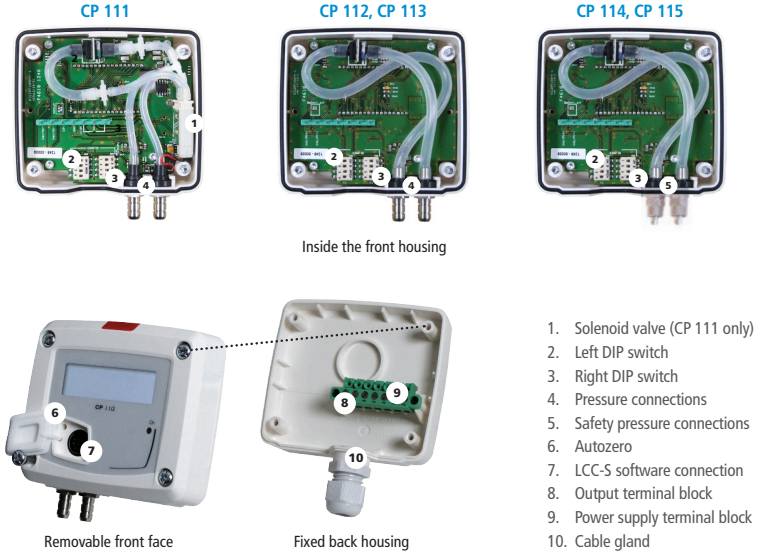

Electrical connections as per NFC15-100 standard

⚠️ This connection must be made by a qualified and trained technician. To make the connection, the transmitter must NOT BE ENERGIZED.

For CP 111/112/113/114/115 – AO models and CP 111/112/113/114/115 – AN models with 0-10 V or 4-20 mA output – active, 4 wires:

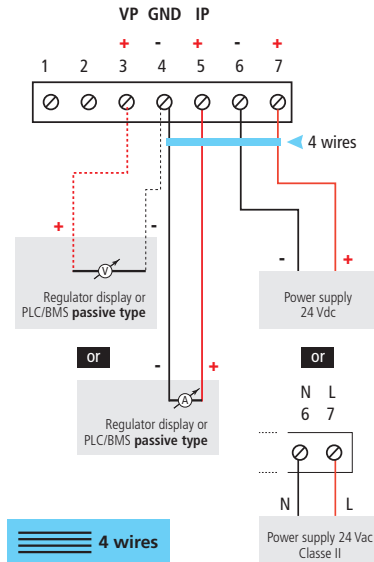

⚠️ To make a 3-wire connection, BEFORE POWERING UP THE TRANSMITTER, please connect the output ground to the input ground. See drawing below.

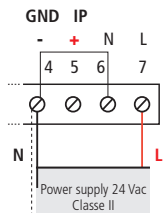
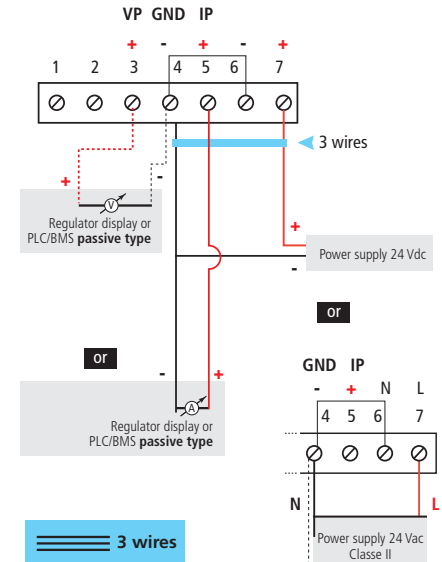

For CP 111/112/113/114/115 – PO models and CP 111/112/113/114/115 – PN models
with 4-20 mA output – passive

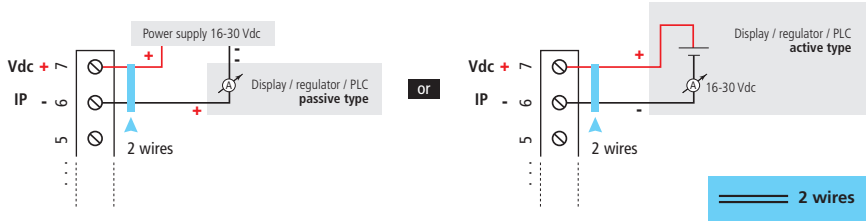

Settings and use of the transmitter

Auto-calibration

CP 111 pressure transmitter has a temperature compensation of the gain from 0 to 50°C and an auto-calibration process that guarantees over the time an excellent stability and a perfect reliability of the measurement on low and high ranges.

Auto-calibration principle: the microprocessor of the transmitter drives a solenoid valve that compensates the possible drifts on the sensitive element over the time. The compensation is



To configure the transmitter, it must not be energized. Then, you can make the settings required, with the DIP switches (as shown on the drawing below). When the transmitter is configured, you can power it up.

performed by the permanent adjustment of the zero. So the measurement of the differential pressure is then independent from the environmental conditions of the transmitter.

Advantage: no drift

Frequency of auto-calibration: resetable or from 1 to 60 minutes.

Autozero

To perform an autozero, unplug the 2 pressure connections tubes and press the "Autozero" key.

On the CP 111 transmitter, it is not necessary to unplug the 2 pressure connection tubes.

When an autozero has been performed, "On" green light turns off then turns on, and on transmitters equipped with a display, "autoZ" is displayed.

Configuration

To configure the transmitter, unscrew the 4 screws from the housing then open it. DIP switches allowing the different settings are then accessible.

Left DIP switch

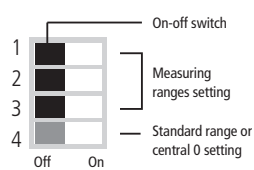

Right DIP switch

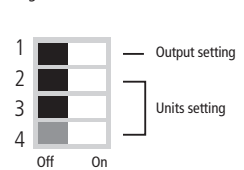

Measuring range settings – left DIP switch

To set a measuring range, put the 1, 2 and 3 on-off switches as indicated in the table below.

CP 111, CP 112, CP 113

Type of transmitter	Combination 1			Combination 2			Combination 3			Combination 4			Combination 5		
	CP111	CP112	CP113	CP111	CP112	CP113	CP111	CP112	CP113	CP112	CP111	CP113	CP111	CP112	CP113
Pa	20	100	1000	30	250	2500	40	500	5000	50	750	7500	100	1000	10000
mmH ₂ O	2.0	10.0	100.0	3.0	25.0	250.0	4.0	50.0	500	5.0	75.0	750.0	10.0	100.0	1000.0
mbar	0.20	1.00	10.00	0.30	2.50	25.00	0.40	5.00	50.00	0.50	7.50	75.00	1.00	10.00	100.00
inWG	0.08	0.40	4.00	0.12	1.00	10.00	0.16	2.00	20.00	0.20	3.00	30.00	0.40	4.00	40.00
mmHg	0.20	0.80	8.00	0.22	2.00	20.00	0.30	4.00	40.00	0.40	6.00	60.00	0.80	8.00	80.00
daPa	2.0	10.0	100	3.0	25.0	250.0	4.0	50.0	500.0	5.0	75.0	750.0	10.0	100.0	1000.0
kPa	0.020	0.100	1.00	0.030	0.250	2.50	0.040	0.500	5.00	0.050	0.750	7.50	0.100	1.000	10.00
hPa	0.20	1.00	10.00	0.30	2.50	25.00	0.40	5.00	50.00	0.50	7.50	75.00	1.00	10.00	100.00

- Measuring ranges of the CP 111 transmitter on the ± 100 Pa range according to the measurement unit
- Measuring ranges of the CP 112 transmitter on the ± 1000 Pa range according to the measurement unit
- Measuring ranges of the CP 113 transmitter on the $\pm 10\,000$ Pa range according to the measurement unit

Example:

- From 0 to 750 mmH₂O, measuring range is 750 mmH₂O.
- From -500 Pa to +500 Pa, measuring range is 1000 Pa

CP 114, CP 115

	Combination 1		Combination 2		Combination 3		Combination 4		Combination 5	
Type of transmitter	CP114	CP115	CP114	CP115	CP114	CP115	CP114	CP115	CP114	CP115
mbar	100	500	200	750	300	1 000	400	1 500	500	2 000
inWG	40.0	200.0	80.0	300.0	120.0	400.0	160.0	600.0	200.0	800.0
kPa	10.0	50.0	20.0	75.0	30.0	100.0	40.0	150.0	50.0	200.0
PSI	2.0	10.0	4.0	15.0	6.0	20.0	8.0	30.0	10.0	40.0
mmHg	80	400	160	600	240	800	320	1 200	400	1 600
mmH ₂ O	1 000	5 000	2 000	7 500	3 000	10 000	4 000	15 000	5 000	20 000
daPa	1.0	5.0	2.0	7.5	3.0	10.0	4.0	15.0	5.0	20.0
hPa	100	500	200	750	300	1 000	400	1 500	500	2 000

- Measuring ranges of the CP 114 transmitter on the ± 500 mbar range according to the measurement unit.
- Measuring ranges of the CP 115 transmitter on the ± 2000 mbar range according to the measurement unit.

Example:

- From 0 to 750 mmH₂O, measuring range is 750 mmH₂O.
- From -500 mbar to +500 mbar, measuring range is 1000 mbar.

Standard range / central zero setting – left DIP switch

 Please follow carefully the combinations beside with the DIP switch. If the combination is wrongly done, the following message will appear on the display of the transmitter "CONF ERROR". In that case, you will have to unplug the transmitter, place the DIP switches correctly, and then power the transmitter up.

	Configurations	Full scale	Central zero
Combinations			

Example:

- 0 - 100 Pa: Full scale / 0  (0 / 100 Pa)
- Central zero  (-50 Pa / 0 / +50 Pa)

Output setting – right DIP switch (CP 111/112/113/114/115 – AO and CP 111/112/113 – AN models)

To set the type of analogue output, please put the on-off switch of the output as shown beside.

	Configurations	4-20 mA	0-10 V
Combinations			

Units setting – right DIP switch

To set a measurement unit, put the on-off switches 2, 3 and 4 of the units as shown in the table below.

CP 111, CP 112, CP 113

Configurations	Pa	mmH ₂ O	mbar	inWG	mmHG	daPa	kPa	hPa
Combinations								

CP 114, CP 115

Configurations	mbar	inWG	kPa	PSI	mmHG	mmH ₂ O	daPa	hPa
Combinations								

Configuration via LCC-S software (option)

An easy and friendly configuration with the software!
You can configure your own intermediary ranges.

⚠ The minimum difference between the high range and the low range is 20.

For example, it is possible to set the instrument from -20 to 0 Pa, from 0 to +20 Pa, or from -10 to +10 Pa...

To access the configuration via software: set the DIP switches as shown beside.

Note: the on-off switch 1 of the right DIP switch can be in any position (selection of the analogue output 0-10 V or 4-20 mA).

Connect the cable of the LCC-S to the connection of the transmitter.

⚠ The configuration of the parameters can be done either with the DIP switch or via software (you cannot combine both solutions).

Mounting

To mount the transmitter, mount the ABS plate on the wall (drilling: \varnothing 6 mm, screws and pins are supplied).

Insert the transmitter on the fixing plate (see A on the drawing beside). Rotate the housing in clockwise direction until you hear a "click" which confirms that the transmitter is correctly installed.

⚠ Once the transmitter is installed and powered up, please make an autozero to guarantee the correct working of the transmitter in any position.

Accessories

Please refer to the data sheet to get more information about available accessories.

Maintenance: please avoid any aggressive solvent. Please protect the transmitter and its probes from any cleaning product containing formalin, that may be used for cleaning rooms or ducts.

Precautions for use: please always use the device in accordance with its intended use and within parameters described in the technical features in order not to compromise the protection ensured by the device.

Configuration via PC

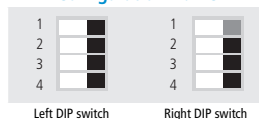

Left DIP switch

Right DIP switch

[Refer to the user manual of the LCC-S to make the configuration.](#)

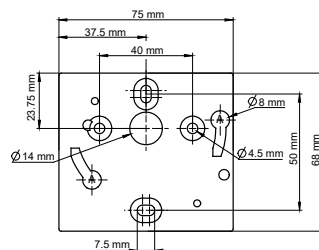



Capteur / transmetteur de pression différentielle



Gamme de -100/+100 Pa à
-2000/+2000 mbar (selon modèle)



Echelles intermédiaires
configurables

Caractéristiques

- Sortie 0-10 V ou 4-20 mA, active, alimentation 24 Vac/Vdc (3-4 fils) ou sortie 4-20 mA, boucle passive, alimentation de 16 à 30 Vdc (2 fils)
- Boîtier ABS V0 IP65, avec ou sans afficheur
- Montage ¼ tour sur platine de fixation murale
- Boîtier avec système de montage simplifié
- Électrovanne d'auto-calibration (CP 111)

Caractéristiques générales

Sortie / Alimentation	Capteur actif 0-10 V ou 4-20 mA (alim. 24 Vac/Vdc $\pm 10\%$), 3-4 fils Capteur boucle passive 4-20 mA (alim. 16/30 Vdc), 2 fils Tension de mode commun < 30 VAC Charge maximale : 500 Ω (4-20 mA) / charge minimale : 1 K Ω (0-10 V)
Consommation	CP 111 : 3 VA (0-10 V) ou 3 VA (4-20 mA) CP112, CP113, CP 114, CP 115 : 2 VA (0-10 V) ou 0.6 VA (4-20 mA)
Directives européennes	2014/30/UE CEM ; 2014/35/UE Basse Tension ; 2011/65/UE RoHS II ; 2012/19/UE DEEE
Raccordement électrique	Bornier à vis pour câbles de 0.05 à 2.5 mm ² ou de 30 à 14 AWG Réalisé suivant les règles de l'art
Communication PC	Câble USB-mini DIN
Environnement	Air et gaz neutre
Temps de réponse	1/e (63%) 0.3 s
Réglage du zéro	Manuel par bouton poussoir ; automatique par électrovanne (CP 111 uniquement)
Type de fluide	Air et gaz neutre
Conditions d'utilisation (°C/%HR/m)	De 0 à +50 °C ; En condition de non condensation ; De 0 à 2000 m
Température de stockage	De -10 à +70 °C

Spécifications techniques

	CP 111	CP 112	CP 113	CP 114	CP 115
Échelles de mesure	-100/+100 Pa	-1000/+1000 Pa	-10000/+10000 Pa	-500/+500 mbar	-2000/+2000 mbar
Unités de mesure	Pa, mmH ₂ O, inWG, mmHG, daPa, kPa, hPa, mbar	Pa, mmH ₂ O, inWG, mmHG, daPa, kPa, hPa, mbar	Pa, mmH ₂ O, inWG, mmHG, daPa, kPa, hPa, mbar	mbar, inWG, mmHG, PSI, mmH ₂ O, daPa, hPa, kPa	mbar, inWG, mmHG, PSI, mmH ₂ O, daPa, hPa, kPa
Exactitudes*	±1% de la lecture ±2 Pa	±1.5% de la lecture ±3 Pa	±1.5% de la lecture ±30 Pa	±1.5% de la lecture ±3 mbar	±1.5% de la lecture ±3 mbar
Résolution	1 Pa; 0.1 mmH ₂ O; 0.01 mbar; 0.01 inWG; 0.01 mmHG; 0.1 daPa; 0.001 kPa; 0.01 hPa	1 Pa; 0.1 mmH ₂ O; 0.01 mbar; 0.01 inWG; 0.01 mmHG; 0.1 daPa; 0.001 kPa; 0.01 hPa	1 Pa; 0.1 mmH ₂ O; 0.01 mbar; 0.01 inWG; 0.01 mmHG; 0.1 daPa; 0.01 kPa; 0.01 hPa	1 mbar; 0.1 inWG; 1 mmHG; 1 mmH ₂ O; 1 hPa; 10 daPa; 0.1 kPa; 0.1 PSI	1 mbar; 0.1 inWG; 1 mmHG; 1 mmH ₂ O; 1 hPa; 10 daPa; 0.1 kPa; 0.1 PSI
Surpression admissible	21 000 Pa	21 000 Pa	69 000 Pa	1400 mbar	4100 mbar

Caractéristiques du boîtier

Matière	ABS V0 selon UL94
Indice de protection	IP65
Afficheur	LCD 10 digits. Dimensions : 50 x 17 mm Hauteur des caractères : valeurs : 10 mm ; unités : 5 mm
Raccords	Cannelés Ø 6.2 mm
Presse étoupe	Pour câbles Ø 8 mm maximum
Poids	143 g

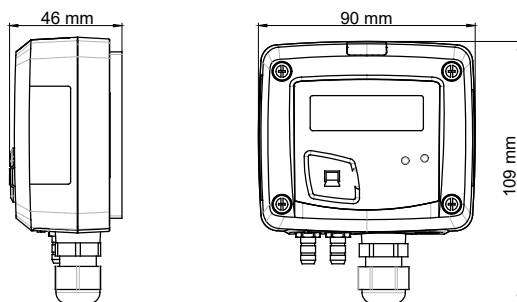

Symboles utilisés

Pour votre sécurité et afin d'éviter tout endommagement de l'appareil, veuillez suivre la procédure décrite dans ce document et lire attentivement les notes précédées du symbole suivant :

Le symbole suivant sera également utilisé dans ce document. Veuillez lire attentivement les notes d'informations indiquées après ce symbole.



Connectiques

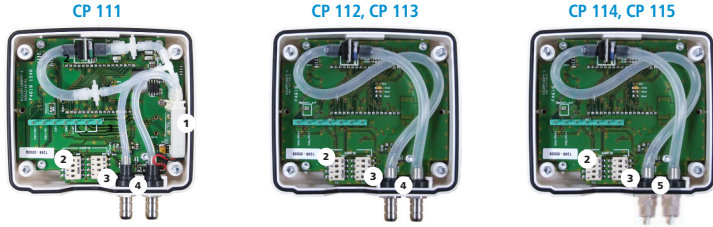

Intérieur de la coque avant

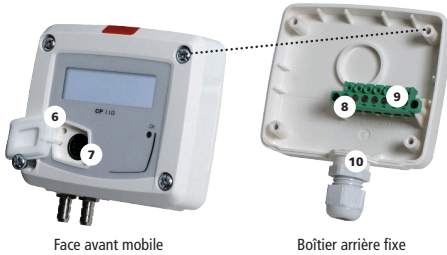

Face avant mobile

Boîtier arrière fixe

1. Electrovanne (uniquement CP 111)
2. Switchs
3. Switchs
4. Prises de pression
5. Raccords de sécurité
6. Autozéro
7. Connexion Logiciel LCC-S
8. Bornier de sortie
9. Bornier d'alimentation
10. Presse-étoupe

Raccordements électriques suivant normes NFC15-100



Seul un technicien formé et qualifié peut réaliser cette opération.
Pour réaliser le raccordement, l'appareil doit être HORS-TENSION.

Pour les modèles CP 111/112/113/114/115 – AO et CP 111/112/113/114/115 – AN avec sortie 0-10 V ou 4-20 mA – actif, 4 fils :

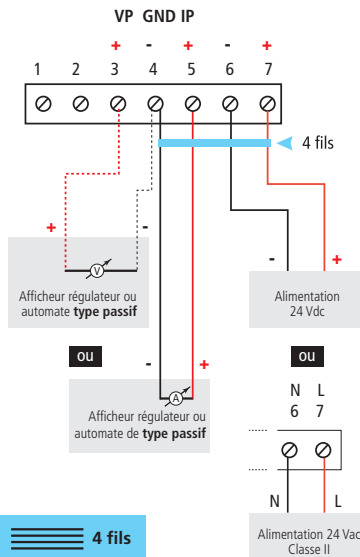

Pour un raccordement 3 fils, la masse de la sortie et la masse d'entrée doivent être reliées AVANT TOUTE MISE SOUS TENSION. Voir schéma ci-dessous.

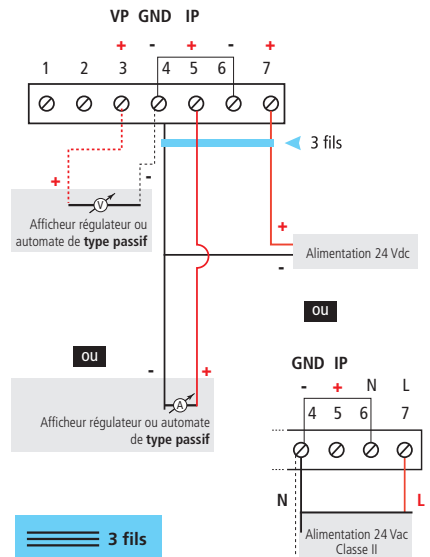

Pour les modèles CP 112/113/114/115 – PO et CP 112/113/114/115 – PN
avec sortie 0-10 V ou 4-20 mA passif :

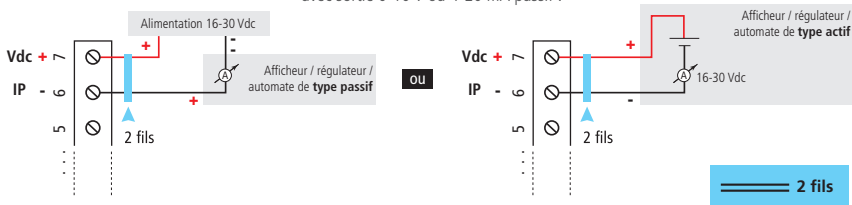

Réglages et utilisation du capteur

Auto-calibration

Les capteurs de pression CP 111 possèdent une compensation en température du gain de 0 à 50 °C et un processus d'auto-calibration qui garantissent dans le temps une excellente stabilité et une parfaite fiabilité de la mesure en basse comme en haute échelle. Principe de l'auto-calibration : le micro-processeur du capteur pilote une électrovanne qui compense les éventuelles dérives de l'élément sensible au cours du temps.

La compensation est assurée par l'ajustage permanent du zéro. La mesure de pression différentielle ainsi réalisée est alors indépendante des conditions environnementales du capteur.

Avantage : dérive du zéro nulle
Périodicité de l'autocalibration : débrayable ou de 1 à 60 min.

Autozéro

Pour réaliser un autozéro, il faut débrancher les tubes des 2 prises de pression et appuyer sur le bouton

« Autozéro ». Sur le capteur CP 111, il n'est pas nécessaire de débrancher les tubes des 2 prises de pression. Lorsqu'un autozéro est effectué, le voyant « On », allumé en vert, s'éteint puis se rallume et, pour les capteurs avec écran, « autoZ » s'affiche.

Configuration

Pour configurer le capteur, dévisser les 4 vis du boîtier puis l'ouvrir. Les switches permettant les différents réglages sont alors accessibles.



Pour configurer le capteur, le mettre hors tension puis procéder aux réglages souhaités en disposant les interrupteurs comme décrit ci-contre.

Switch de gauche

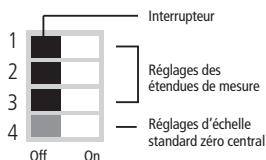

Switch de droite

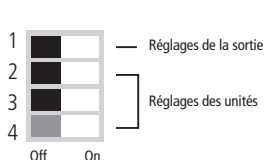

Réglage des étendues de mesure - Switch de gauche

Pour régler une étendue de mesure, positionner les interrupteurs 1, 2 et 3 des étendues de mesure comme indiqué dans le tableau ci-dessous.

CP 111, CP 112, CP 113

Type de capteur	Combinaison 1			Combinaison 2			Combinaison 3			Combinaison 4			Combinaison 5		
	CP111	CP112	CP113	CP111	CP112	CP113	CP111	CP112	CP113	CP112	CP111	CP113	CP111	CP112	CP113
Pa	20	100	1000	30	250	2500	40	500	5000	50	750	7500	100	1000	10000
mmH ₂ O	2.0	10.0	100.0	3.0	25.0	250.0	4.0	50.0	500	5.0	75.0	750.0	10.0	100.0	1000.0
mbar	0.20	1.00	10.00	0.30	2.50	25.00	0.40	5.00	50.00	0.50	7.50	75.00	1.00	10.00	100.00
inWG	0.08	0.40	4.00	0.12	1.00	10.00	0.16	2.00	20.00	0.20	3.00	30.00	0.40	4.00	40.00
mmHg	0.20	0.80	8.00	0.22	2.00	20.00	0.30	4.00	40.00	0.40	6.00	60.00	0.80	8.00	80.00
daPa	2.0	10.0	100	3.0	25.0	250.0	4.0	50.0	500.0	5.0	75.0	750.0	10.0	100.0	1000.0
kPa	0.020	0.100	1.00	0.030	0.250	2.50	0.040	0.500	5.00	0.050	0.750	7.50	0.100	1.000	10.00
hPa	0.20	1.00	10.00	0.30	2.50	25.00	0.40	5.00	50.00	0.50	7.50	75.00	1.00	10.00	100.00

- Étendues de mesure du CP 111 sur l'échelle ± 100 Pa selon l'unité de mesure
- Étendues de mesure du CP 112 sur l'échelle ± 1000 Pa selon l'unité de mesure
- Étendues de mesure du CP 113 sur l'échelle $\pm 10\,000$ Pa selon l'unité de mesure

Exemple :

- De 0 à 750 mmH₂O, l'étendue de mesure est 750 mmH₂O.
- De -500 Pa à +500 Pa, l'étendue de mesure est de 1000 Pa.

CP 114, CP 115

	Combinaison 1		Combinaison 2		Combinaison 3		Combinaison 4		Combinaison 5	
Type de capteur	CP114	CP115	CP114	CP115	CP114	CP115	CP114	CP115	CP114	CP115
mbar	100	500	200	750	300	1 000	400	1 500	500	2 000
inWG	40.0	200.0	80.0	300.0	120.0	400.0	160.0	600.0	200.0	800.0
kPa	10.0	50.0	20.0	75.0	30.0	100.0	40.0	150.0	50.0	200.0
PSI	2.0	10.0	4.0	15.0	6.0	20.0	8.0	30.0	10.0	40.0
mmHg	80	400	160	600	240	800	320	1 200	400	1 600
mmH ₂ O	1 000	5 000	2 000	7 500	3 000	10 000	4 000	15 000	5 000	20 000
daPa	1.0	5.0	2.0	7.5	3.0	10.0	4.0	15.0	5.0	20.0
hPa	100	500	200	750	300	1 000	400	1 500	500	2 000

- Étendues de mesure du CP 114 sur l'échelle ± 500 mbar selon l'unité de mesure
- Étendues de mesure du CP 115 sur l'échelle ± 2000 mbar selon l'unité de mesure

Exemple :

De 0 à 750 mmH₂O, l'étendue de mesure est 750 mmH₂O.

De -500 à +500 mbar, l'étendue de mesure est de 1000 mbar.

Réglage de l'échelle standard et du zéro central Switch de gauche

 Les combinaisons présentées doivent être bien reproduites. Si une mauvaise combinaison est réalisée, le message « CONF ERROR » apparaîtra lors de la mise sous tension du capteur. Il faudra alors débrancher le capteur, l'ouvrir et disposer les interrupteurs des switches correctement avant de le remettre sous tension.

Configurations Pleine échelle Zéro central



Exemple :

- De 0 - 100 Pa : Pleine échelle / 0 Zéro central

 (0 / 100 Pa)

 (-50 Pa / 0 / +50 Pa)

Réglage de la sortie – switch de droite

(modèles CP 111/112/113/114/115 – AO et CP 111/112/113/114/115 – AN)

Pour régler le type de sortie analogique, positionner l'interrupteur 1 de la sortie comme indiqué ci-contre.

Configurations 4-20 mA 0-10 V



Réglage des unités – switch de droite

Pour régler le type de sortie analogique, positionner l'interrupteur 1 de la sortie comme indiqué ci-dessous.

CP 111, CP 112, CP 113

Configurations	Pa	mmH ₂ O	mbar	InWG	mmHG	daPa	kPa	hPa
Combinaisons								

CP 114, CP 115

Configurations	mbar	inWG	kPa	PSI	mmHG	mmH ₂ O	daPa	hPa
Combinaisons								

Configuration logiciel LCC-S (option)

Le logiciel permet une configuration plus souple.
Il est possible de configurer des échelles intermédiaires.

⚠ La différence minimum entre l'échelle haute et l'échelle basse est de 20.

Il est possible par exemple de configurer l'appareil de -20 à 0 Pa, de 0 à +20 Pa, ou de -10 à +10 Pa (CP 111/112/113) ou de -20 à 0 mbar, de 0 à +20 mbar, ou de -10 à +10 mbar (CP 114/115)...

Pour accéder à la configuration par logiciel : régler les switches comme indiqué ci-contre. Note : la position du premier interrupteur du switch de droite est indifférente (sélection de la sortie analogique en 0-10 V ou 4-20 mA). Raccorder le câble du LCC-S à la connexion du capteur.

⚠ La configuration des paramètres s'effectue soit par switch soit par logiciel. Les deux ne sont pas compatibles.

Configuration via PC

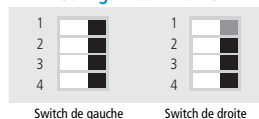

Switch de gauche Switch de droite

Pour procéder à la configuration de votre appareil, voir la notice du logiciel LCC-S.

Montage

Pour réaliser le montage mural, fixer la plaque ABS au mur (perçage Ø 6 mm, vis et chevilles fournies). Insérer le capteur dans la plaque de fixation (aux points A sur le schéma) en l'inclinant à 30°. Faire pivoter le boîtier dans le sens des aiguilles d'une montre jusqu'à l'obtention d'un clipage ferme.

⚠ Une fois le capteur mis en place et sous tension, effectuer la procédure d'autozéro garantissant le bon fonctionnement du capteur, quelle que soit sa position de montage.

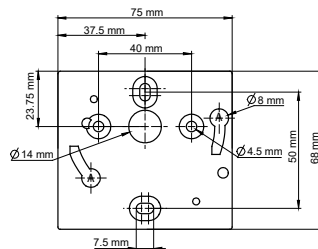

Accessoires

Se référer à la fiche technique pour plus d'informations sur les accessoires disponibles.

Entretien : éviter tous les solvants agressifs. Lors du nettoyage à base de produits formolés (pièces ou conduits), protéger l'appareil.

Précautions d'utilisation : veillez à toujours utiliser l'appareil conformément à l'usage prévu et dans les limites des paramètres décrits dans les caractéristiques techniques afin de ne pas compromettre la protection assurée par l'appareil.



Transmisores de presión diferencial



Rangos de -100/+100 Pa hasta -2000/+2000 mbar (según el modelo)



Rangos intermedios configurables

Características

- Señal analógica seleccionable 0-10 V o 4-20 mA en activo con alimentación a 24 Vac/Vdc (3 o 4 hilos), o señal analógica 4-20 mA en lazo pasivo con alimentación de 16 a 30 Vdc (2 hilos)
- Caja fabricada en ABS V0 IP65, pantalla opcional
- Montaje sobre base de fijación en pared mediante sistema 1/4 de vuelta
- Caja con un nuevo sistema de montaje simplificado
- Electroválvula para autocalibración en el modelo CP 111 (rango de -100 Pa a 100 Pa)

Características generales

Señal / Alimentación	Transmisor activo: 0-10 V o 4-20 mA (alimentación 24 Vac/Vdc $\pm 10\%$), 3-4 hilos Transmisor pasivo: 4-20 mA (alimentación 16/30 Vdc), 2 hilos Modo común voltaje < 30 Vac Carga máxima: 500 Ω (4-20 mA) Carga mínima: 1 k Ω (0-10 V)
Consumo	CP 111: 3 VA (0-10 V) o 3 VA (4-20 mA) CP112, CP113, CP 114, CP 115: 2 VA (0-10 V) o 0.6 VA (4-20 mA)
Directivas europeas	2014/30/UE CEM; 2014/35/UE Baja Tensión; 2011/65/UE RoHS II; 2012/19/UE RAEE
Conexiones eléctricas	Bornes con tornillo para cables de \varnothing 0.05 a 2.5 mm ² o de 30 a 14 AWG. Efectuado siguiendo las normas estándares.
Comunicación con ordenador	Cable USB-miniDin
Ambiente de trabajo	Aire y gases neutros
Tiempo de respuesta	1/e (63%) 0,3 s
Autocero	Manual mediante pulsación de botón, automático mediante electroválvula (sólo en el modelo CP 111)
Tipo de fluido	Aire y gases neutros
Condiciones de uso (°C/%HR/m)	De 0 °C a 50 °C sin condensación. De 0 a 2000 m
Temperatura de almacenaje	De -10 a +70 °C

Especificaciones técnicas

	CP 111	CP 112	CP 113	CP 114	CP 115
Rangos de medición	-100/+100 Pa	-1000/+1000 Pa	-10000/+10000 Pa	-500/+500 mbar	-2000/+2000 mbar
Unidades de medición	Pa, mmH ₂ O, inWG, mmHG, daPa, kPa, hPa, mbar	Pa, mmH ₂ O, inWG, mmHG, daPa, kPa, hPa, mbar	Pa, mmH ₂ O, inWG, mmHG, daPa, kPa, hPa, mbar	mbar, inWG, mmHG, PSI, mmH ₂ O, daPa, hPa, kPa	mbar, inWG, mmHG, PSI, mmH ₂ O, daPa, hPa, kPa
Precisión*	±1% de la lectura ±2 Pa	±1.5% de la lectura ±3 Pa	±1.5% de la lectura ±30 Pa	±1.5% de la lectura ±3 mbar	±1.5% de la lectura ±3 mbar
Resolución	1 Pa; 0.1 mmH ₂ O; 0.01 mbar; 0.01 inWG; 0.01 mmHG; 0.1 daPa; 0.001 kPa; 0.01 hPa	1 Pa; 0.1 mmH ₂ O; 0.01 mbar; 0.01 inWG; 0.01 mmHG; 0.1 daPa; 0.001 kPa; 0.01 hPa	1 Pa; 0.1 mmH ₂ O; 0.01 mbar; 0.01 inWG; 0.01 mmHG; 0.1 daPa; 0.01 kPa; 0.01 hPa	1 mbar; 0.1 inWG; 1 mmHG; 1 mmH ₂ O; 1 hPa; 10 daPa; 0.1 kPa; 0.1 PSI	1 mbar; 0.1 inWG; 1 mmHG; 1 mmH ₂ O; 1 hPa; 10 daPa; 0.1 kPa; 0.1 PSI
Sobrepresión máxima	21 000 Pa	21 000 Pa	69 000 Pa	1400 mbar	4100 mbar

Características de la caja

Material	ABS V0 as per UL94
Índice de protección	IP65
Pantalla	LCD 50 x 17 mm de 10 dígitos Altura de caracteres: Valores 10 mm; unidades 5 mm
Rácores	Acanalados, Ø 6,2 mm
Prensa-estopa	Para cables de Ø 8 mm máximo
Peso	143 g

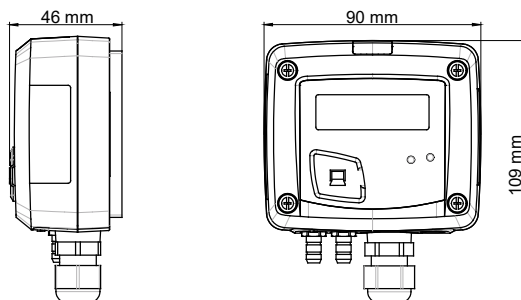

Símbolos utilizados

Por su seguridad y para evitar daños en el dispositivo, siga el procedimiento descrito en el presente documento y lea atentamente las notas precedidas del siguiente símbolo:



El siguiente símbolo también se utiliza en el presente documento. Lea atentamente las notas informativas indicadas tras este símbolo.



Conexiones

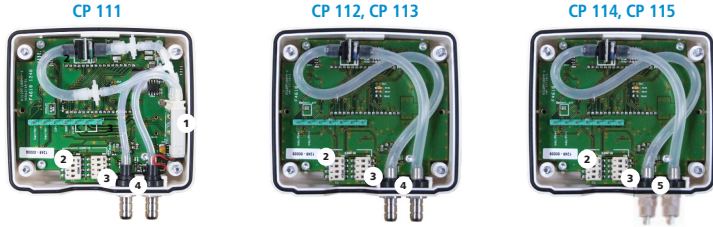

Interior de la parte frontal

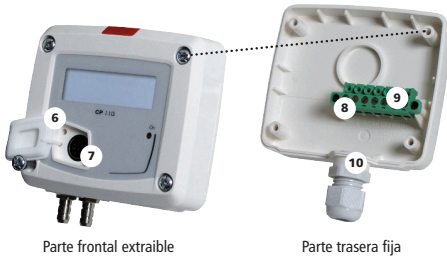

Parte frontal extraíble

Parte trasera fija

1. Electroválvula (sólo en el modelo CP 111)
2. Switchs
3. Switchs
4. Tomas de presión
5. Tomas de presión de seguridad
6. Autocero
7. Conexión LCC-S
8. Salida de señal
9. Bornes de alimentación
10. Prensaestopa

Conexiones eléctricas (según normativa NFC150)



Sólo un técnico cualificado puede efectuar estas conexiones.
Debe llevar a cabo esta instalación cuando el instrumento no tenga tensión.

Para los modelos CP 111/112/113/114/115 – AO y
CP 111/112/113/114/115 – AN con salida 0-10 V o
4-20 mA – activo a 4 hilos:

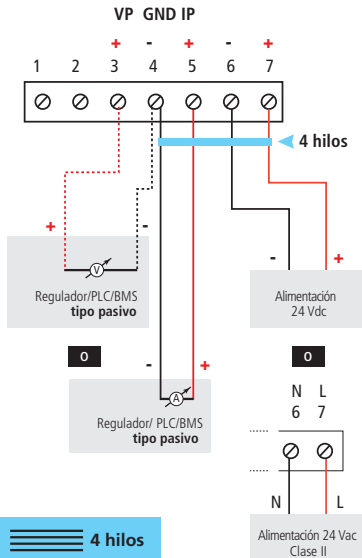

EN LA CONEXIÓN A 3 HILOS, la interconexión entre las tomas a tierra (GND) de salida de señal y de alimentación debe realizarse antes de alimentar el equipo.

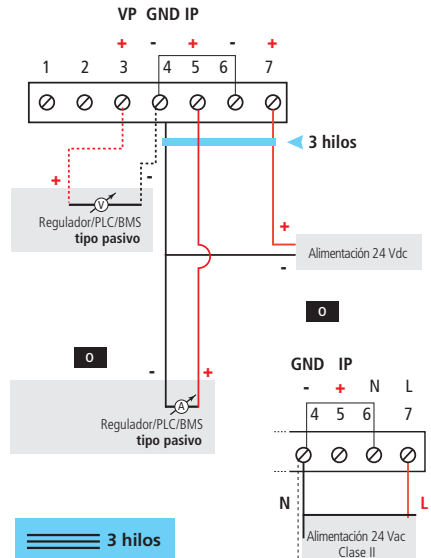

Para los modelos CP 111/112/113/114/115 – PO y CP 111/112/113/114/115 – PN
con salida 4-20 mA – lazo pasivo a 2 hilos:

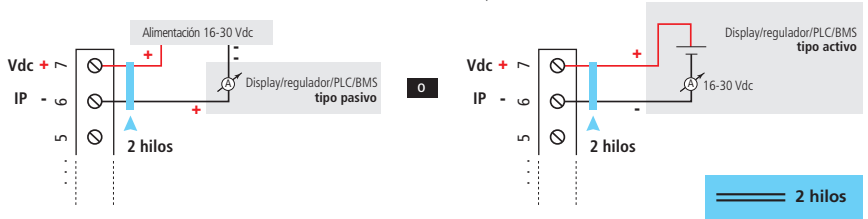

Configuración y uso del transmisor

Autocalibración

Los transmisores de presión CP111 poseen una compensación de temperatura entre 0 °C y 50 °C y un proceso de autocalibración que garantiza estabilidad y fiabilidad en la medición de presión diferencial, tanto en rangos bajos, como en rangos altos. Esta autocalibración se basa en la actuación de la electroválvula controlada por un microprocesador, que compensa las derivas del sensor que suceden a lo largo del tiempo ajustando permanentemente

el cero. La deriva del cero es nula. La medición de la presión diferencial que efectúa el sensor es totalmente independiente de factores ambientales del transmisor. Se puede ajustar la periodicidad de la autocalibración entre 1 minuto y 60 minutos.

Autocero

TEL autocero puede hacerse en todos los modelos CP 110 simplemente quitando los tubos de las tomas de presión y pulsando el botón "Autocero" durante

unos segundos.

En el caso del modelo CP111, no es necesario retirar los tubos de las tomas de presión. Una vez el autocero se realiza, se enciende el piloto luminoso verde "ON" y en los transmisores con pantalla se muestra el mensaje "AutoZ".

Configuración

Para configurar el transmisor, desatornillar los 4 tornillos de la caja y ábrala. Los bloques de microinterruptores permiten realizar diferentes configuraciones.



Para configurar el transmisor, debe proceder a colocar los interruptores según se describe a continuación cuando el equipo esté sin alimentación. Reestablezca la alimentación una vez haya completado la configuración.

Bloque izquierdo

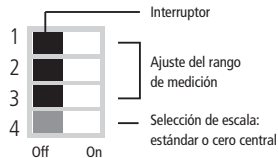

Bloque derecho

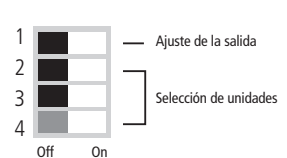

Configuración del rango de medición (bloque izquierdo)

Para configurar el rango de medición, posicionando los interruptores 1, 2 y 3 según se indica a continuación.

CP 111, CP 112, CP 113

Modelo	Combinación 1			Combinación 2			Combinación 3			Combinación 4			Combinación 5		
	CP111	CP112	CP113	CP111	CP112	CP113	CP111	CP112	CP113	CP112	CP111	CP113	CP111	CP112	CP113
Pa	20	100	1000	30	250	2500	40	500	5000	50	750	7500	100	1000	10000
mmH ₂ O	2.0	10.0	100.0	3.0	25.0	250.0	4.0	50.0	500	5.0	75.0	750.0	10.0	100.0	1000.0
mbar	0.20	1.00	10.00	0.30	2.50	25.00	0.40	5.00	50.00	0.50	7.50	75.00	1.00	10.00	100.00
inWG	0.08	0.40	4.00	0.12	1.00	10.00	0.16	2.00	20.00	0.20	3.00	30.00	0.40	4.00	40.00
mmHg	0.20	0.80	8.00	0.22	2.00	20.00	0.30	4.00	40.00	0.40	6.00	60.00	0.80	8.00	80.00
daPa	2.0	10.0	100	3.0	25.0	250.0	4.0	50.0	500.0	5.0	75.0	750.0	10.0	100.0	1000.0
kPa	0.020	0.100	1.00	0.030	0.250	2.50	0.040	0.500	5.00	0.050	0.750	7.50	0.100	1.000	10.00
hPa	0.20	1.00	10.00	0.30	2.50	25.00	0.40	5.00	50.00	0.50	7.50	75.00	1.00	10.00	100.00

- Los rangos intermedios de medición del transmisor CP 111 entre ± 100 Pa depende de la unidad de medición seleccionada
- Los rangos intermedios de medición del transmisor CP 112 entre ± 1000 Pa depende de la unidad de medición seleccionada
- Los rangos intermedios de medición del transmisor CP 113 entre $\pm 10\,000$ Pa depende de la unidad de medición seleccionada

Ejemplos:

- De 0 a 750 mmH₂O: el rango de medición que debe seleccionarse es 750 mmH₂O.
- De -500 a +500 Pa: el rango de medición que debe seleccionarse es 1000 Pa.

CP 114, CP 115

	Combinación 1		Combinación 2		Combinación 3		Combinación 4		Combinación 5	
Modelo	CP114	CP115	CP114	CP115	CP114	CP115	CP114	CP115	CP114	CP115
mbar	100	500	200	750	300	1 000	400	1 500	500	2 000
inWG	40.0	200.0	80.0	300.0	120.0	400.0	160.0	600.0	200.0	800.0
kPa	10.0	50.0	20.0	75.0	30.0	100.0	40.0	150.0	50.0	200.0
PSI	2.0	10.0	4.0	15.0	6.0	20.0	8.0	30.0	10.0	40.0
mmHg	80	400	160	600	240	800	320	1 200	400	1 600
mmH ₂ O	1 000	5 000	2 000	7 500	3 000	10 000	4 000	15 000	5 000	20 000
daPa	1.0	5.0	2.0	7.5	3.0	10.0	4.0	15.0	5.0	20.0
hPa	100	500	200	750	300	1 000	400	1 500	500	2 000

- Los rangos intermedios de medición del transmisor CP 114 entre ± 500 mbar depende de la unidad de medición seleccionada
- Los rangos intermedios de medición del transmisor CP 115 entre ± 2000 mbar depende de la unidad de medición seleccionada

Ejemplos:

- De 0 a 750 mmH₂O: el rango de medición que debe seleccionarse es 750 mmH₂O.
- De -500 a +500 mbar: el rango de medición que debe seleccionarse es 1000 mbar.

Configuración de escala estándar o cero central (bloque izquierdo)

 Compruebe la correcta selección de los interruptores según los esquemas indicados. Si por algún error se conectara uno de ellos de forma incorrecta aparecería en pantalla el siguiente mensaje: "CONF ERROR". En este caso sería necesario quitar la alimentación y posicionar los interruptores de la forma correcta.



Ejemplo:

- De 0 a 100 Pa: Toda la escala  (0 / 100 Pa)
- De -50 Pa / 0 / +50 Pa: Cero central  (-50 Pa / 0 / +50 Pa)

Configuración la salida de señal (bloque derecho)
(Modelos CP 111/112/113/114/115 –AO y CP 111/112/113 –AN)

Para seleccionar el tipo de salida analógica, posicionar el interruptor 1 para la salida según de indica en el siguiente gráfico.

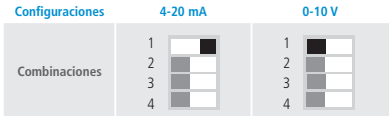

Configuración de las unidades de medición (bloque derecho)

Para configurar las unidades de medición, posicionar los interruptores 2, 3 y 4 según se indica a continuación.

CP 111, CP 112, CP 113

Configuraciones	Pa	mmH ₂ O	mbar	inWG	mmHG	daPa	kPa	hPa
Combinaciones								

CP 114, CP 115

Configuraciones	mbar	inWG	kPa	PSI	mmHG	mmH ₂ O	daPa	hPa
Combinaciones								

Configuración con el programa LCC-5 (opcional)

Una configuración flexible gracias al programa LCC-5.
Podrá configurar usted mismo sus propias escalas.

⚠ La diferencia mínima entre el valor máximo y el mínimo de la escala debe ser de 20.

Se puede, por ejemplo, configurar la salida de -20 a 0 Pa, de 0 a 20 Pa, o de -10 a 10 Pa...

Para acceder a la configuración por software, es necesario ajustar los interruptores previamente como se indica en el gráfico y conectar el cable al conector específico en la electrónica.

⚠ La configuración debe realizarse a través de los interruptores DIP o mediante programa (no pueden combinarse ambos métodos).

Posición para configuración con LCC-5

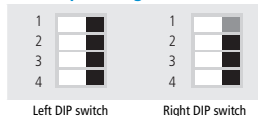

Left DIP switch

Right DIP switch

Para proceder a la configuración del equipo, consulte el manual del programa LCC-5.

Montaje

Para realizar el montaje mural, fijar la placa de ABS en la pared (suministrada con el equipo). Tornillería: Ø 6 mm (tornillos y tacos suministrados). Colocar el equipo a la placa de fijación y rotar 30°. Hacer pivotar la caja en sentido de las agujas del reloj hasta obtener una fijación segura.

⚠ Una vez el equipo esté instalado y alimentado, se recomienda efectuar el proceso de ajuste del cero para garantizar un funcionamiento óptimo, sea cual sea su posición de montaje.

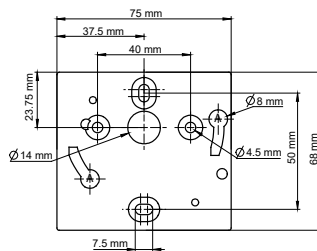

Accesorios

Consulte la ficha técnica para obtener más información sobre los accesorios disponibles.

Mantenimiento: evite el contacto con disolventes agresivos. Proteja el transmisor y sus sondas de cualquier producto de limpieza que contenga formalina.

Precauciones en el uso del dispositivo: use siempre el dispositivo de acuerdo con la aplicación para la cual está destinado y dentro de los parámetros descritos en las características técnicas para no comprometer la protección garantizada del dispositivo.



Trasmettitore di pressione differenziale



Range da -100/+100 Pa a
-2000/+2000 mbar (a seconda dei modelli)



Range intermedi
configurabili

Caratteristiche

- Output 0-10 V o 4-20 mA, attivo, alimentazione 24 Vac/Vdc (3-4 fili) o output 4-20 mA, circuito passivo, alimentazione da 16 a 30 Vdc (2 fili)
- Custodia ABS V0, IP65, con o senza display
- Sistema di montaggio con piastra per il fissaggio al muro con "rotazione di 1/4"
- Custodia con sistema di montaggio semplificato
- Valvola solenoide per auto-taratura (solo sul modello CP 111)

Caratteristiche tecniche

Output / Alimentazione	Sensore attivo 0-10 V o 4-20 mA (alim. 24 Vac/Vdc \pm 10%), 3-4 fili Circuito passivo 4-20 mA (alimentazione 16/30 Vdc), 2 fili Carico massimo: 500 Ohms (4-20 mA) Carico minimo: 1 K Ohms (0-10 V)
Consumo	CP 111: 3 VA (0-10 V) o 3 VA (4-20 mA) CP112, CP113, CP 114, CP 115: 2 VA (0-10 V) o 0.6 VA (4-20 mA)
Direttive dell'Unione Europea	2011/65UE RoHS II; 2012/19/UE WEEE; 2014/30/UE EMC; 2014/35/UE
Connessione elettrica	Avvitare blocco terminale per i cavi \varnothing 0.05 a 2.5 mm ² o da 30 a 14 AWG Secondo il codice di buon utilizzo
Connessione al PC	Cavo USB-mini Din Kimo
Ambiente	Aria e gas neutri
Tempo di risposta	1/e (63%) 0.3 s
Autozero	Manuale con pulsante; Automatico attraverso la valvola solenoide (solo sul modelo CP 111)
Tipo di fluido	Aria e gas neutri
Condizioni di utilizzo (°C/%HR/m)	Da 0 a +50 °C. In condizione non condensante. Da 0 a 2000 m.
Temperatura di stoccaggio	Da -10 a +70 °C

Caratteristiche tecniche

	CP 111	CP 112	CP 113	CP 114	CP 115
Range di misura	-100/+100 Pa	-1000/+1000 Pa	-10000/+10000 Pa	-500/+500 mbar	-2000/+2000 mbar
Unità di misura	Pa, mmH ₂ O, inWG, mmHG, daPa, kPa, hPa, mbar	Pa, mmH ₂ O, inWG, mmHG, daPa, kPa, hPa, mbar	Pa, mmH ₂ O, inWG, mmHG, daPa, kPa, hPa, mbar	mbar, inWG, mmHG, PSI, mmH ₂ O, daPa, hPa, kPa	mbar, inWG, mmHG, PSI, mmH ₂ O, daPa, hPa, kPa
Precisione*	±1% del valore di misura ±2 Pa	±1.5% del valore di misura ±3 Pa	±1.5% del valore di misura ±30 Pa	±1.5% del valore di misura ±3 mbar	±1.5% del valore di misura ±3 mbar
Risoluzione	1 Pa; 0.1 mmH ₂ O; 0.01 mbar; 0.01 inWG; 0.01 mmHG; 0.1 daPa; 0.001 kPa; 0.01 hPa	1 Pa; 0.1 mmH ₂ O; 0.01 mbar; 0.01 inWG; 0.01 mmHG; 0.1 daPa; 0.001 kPa; 0.01 hPa	1 Pa; 0.1 mmH ₂ O; 0.01 mbar; 0.01 inWG; 0.01 mmHG; 0.1 daPa; 0.01 kPa; 0.01 hPa	1 mbar; 0.1 inWG; 0.01 mbar; 1 mmHG; 1 mmH ₂ O; 1 hPa; 10 daPa; 0.1 kPa; 0.1 PSI	1 mbar; 0.1 inWG; 1 mmHG; 1 mmH ₂ O; 1 hPa; 10 daPa; 0.1 kPa; 0.1 PSI
Sovrappressione tollerata	21 000 Pa	21 000 Pa	69 000 Pa	1400 mbar	4100 mbar

Caratteristiche della custodia

Materiale	ABS V0 come da UL94
Protezione	IP65
Display	LCD 10 cifre. Dimensioni: 50 x 17 mm Dimensione Digit: Valori: 10 mm; Unità: 5 mm
Connessioni	Scanalate, Ø 6.2 mm
Passacavo	Per cavi di massimo Ø 8 mm
Peso	143 g

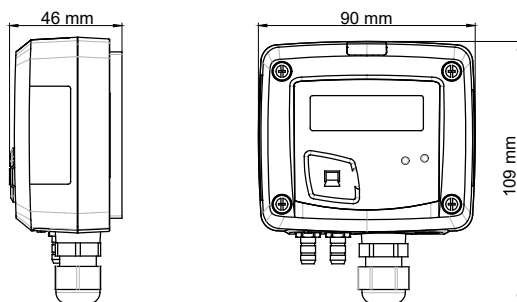

Simboli utilizzati

Il seguente simbolo compare vicino a note relative alla sicurezza e per evitare danni al dispositivo. Seguire la procedura descritta in questo manuale utente:

Il seguente simbolo compare vicino a note importanti relative al corretto uso.



Connessioni

CP 111

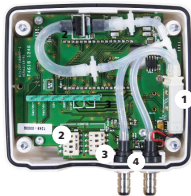

CP 112, CP 113

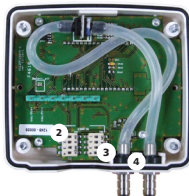

CP 114, CP 115

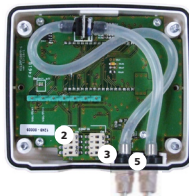

Interno della parte frontale



Frontalino rimovibile

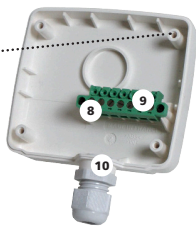

Retro della custodia fisso

1. Valvola solenoide (solo CP 111)
2. Interruttore sinistro DIP
3. Interruttore destro DIP
4. Collegamenti pressione
5. Attacchi di pressione di sicurezza
6. Autozero
7. Connessione LCC-S
8. Blocco terminale output
9. Blocco terminale alimentazione
10. Passacavo

Connessioni elettriche – come da standard NFC15-100



Questa connessione deve essere eseguita da un tecnico qualificato.
Per effettuare la connessione, il trasmettitore non deve essere energizzato.

Per i modelli CP 111/112/113 – AO e i modelli CP 111/112/113 – AN con output 0-10 V o 4-20 mA – attivo, 4 fili:

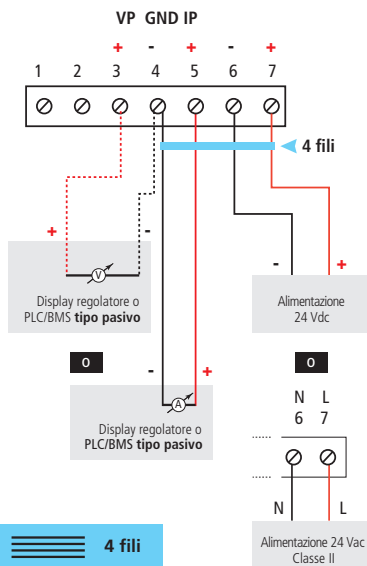

Per eseguire una connessione a 3 fili, prima di accendere il trasmettitore, connettere la presa input a quella output. Vedere il disegno qui sotto.

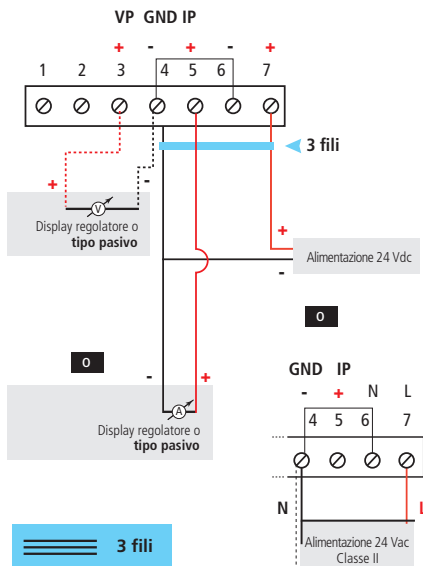

Per i modelli CP 112/113/114/115 – PO e CP 112/113/114/115 – PN
con output 4-20 mA – passivo:

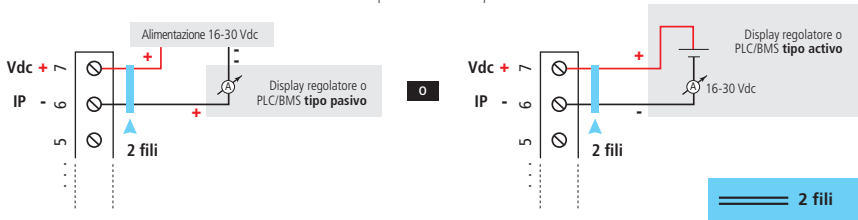

Impostazioni de uso del trasmettitore

Auto-taratura

Il trasmettitore di pressione CP 111 ha una compensazione di temperatura di aumento da 0 a 50 °C e un processo di auto-taratura che garantisce nel tempo un'eccellente stabilità e una perfetta attendibilità della misura su range alti e bassi.

Principio di auto-taratura: il microprocessore del trasmettitore guida la valvola solenoide che compensa i possibili accumuli sull'elemento sensibile nel tempo. La compensazione è eseguita da una

regolazione permanente dello zero. Cosicché la misura della pressione differenziale è quindi indipendente dalle condizioni ambientali del trasmettitore.

Vantaggio: nessun accumulo
Frequenza di auto-taratura: resettabile o da 1 a 60 minuti

Autozero

Per eseguire un autozero, scollegare i 2 tubi per il collegamento di pressione e premere il tasto "Autozero". Sul trasmettitore CP 111, non è

necessario scollegare i 2 tubi di collegamento di pressione.

Quando un autozero è stato eseguito, la luce verde su "On" si spegne e poi si accende, e sui trasmettitori forniti di display, viene visualizzato "autoZ".

Configurazione

Per configurare il trasmettitore, svitare le 4 viti della custodia e quindi aprirlo. Gli interruttori DIP permettono le varie impostazioni sono accessibili.



Per configurare il trasmettitore, quest'ultimo non deve essere energizzato. E' possibile quindi effettuare le impostazioni necessarie grazie agli interruttori DIP come mostrato nei disegni qui sotto.

Interruttore sinistro DIP

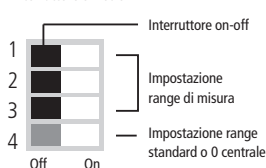

Interruttore destro DIP

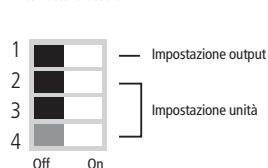

Impostazione del range di misura – interruttore sinistro DIP

Per impostare un range di misura, posizionare l'interruttore on-off 1, 2 e 3 come mostrato qui sotto:

CP 111, CP 112, CP 113

Tipo di trasmettitore	Combinazione 1			Combinazione 2			Combinazione 3			Combinazione 4			Combinazione 5		
	CP111	CP112	CP113	CP111	CP112	CP113	CP111	CP112	CP113	CP112	CP111	CP113	CP111	CP112	CP113
Pa	20	100	1000	30	250	2500	40	500	5000	50	750	7500	100	1000	10000
mmH ₂ O	2.0	10.0	100.0	3.0	25.0	250.0	4.0	50.0	500	5.0	75.0	750.0	10.0	100.0	1000.0
mbar	0.20	1.00	10.00	0.30	2.50	50.00	0.40	5.00	50.00	0.50	7.50	75.00	1.00	10.00	100.00
inWG	0.08	0.40	4.00	0.12	1.00	10.00	0.16	2.00	20.00	0.20	3.00	30.00	0.40	4.00	40.00
mmHg	0.20	0.80	8.00	0.22	2.00	20.00	0.30	4.00	40.00	0.40	6.00	60.00	0.80	8.00	80.00
daPa	2.0	10.0	100.0	3.0	25.0	250.0	4.0	50.0	500.0	5.0	75.0	750.0	10.0	100.0	1000.0
kPa	0.020	0.100	1.00	0.030	0.250	2.50	0.040	0.500	5.00	0.050	0.750	7.50	0.100	1.000	10.00
hPa	0.20	1.00	10.00	0.30	2.50	25.00	0.40	5.00	50.00	0.50	7.50	75.00	1.00	10.00	100.00

- Range di misura del trasmettitore CP 111 sul range ± 100 Pa a seconda dell'unità di misura
- Range di misura del trasmettitore CP 112 sul range ± 1000 Pa a seconda dell'unità di misura
- Range di misura del trasmettitore CP 113 sul range $\pm 10\ 000$ Pa a seconda dell'unità di misura

Esempio:

- Da 0 a 750 mmH₂O, il range di misura è 750 mmH₂O.
- Da -500 Pa a +500 Pa, il range di misura è 1000 Pa.

CP 114, CP 115

Tipo di trasmettitore	Combinazione 1		Combinazione 2		Combinazione 3		Combinazione 4		Combinazione 5	
	CP114	CP115	CP114	CP115	CP114	CP115	CP114	CP115	CP114	CP115
mbar	100	500	200	750	300	1 000	400	1 500	500	2 000
inWG	40.0	200.0	80.0	300.0	120.0	400.0	160.0	600.0	200.0	800.0
kPa	10.0	50.0	20.0	75.0	30.0	100.0	40.0	150.0	50.0	200.0
PSI	2.0	10.0	4.0	15.0	6.0	20.0	8.0	30.0	10.0	40.0
mmHg	80	400	160	600	240	800	320	1 200	400	1 600
mmH ₂ O	1 000	5 000	2 000	7 500	3 000	10 000	4 000	15 000	5 000	20 000
daPa	1.0	5.0	2.0	7.5	3.0	10.0	4.0	15.0	5.0	20.0
hPa	100	500	200	750	300	1 000	400	1 500	500	2 000

- Range di misura del trasmettitore CP 114 sul range ± 500 mbar a seconda dell'unità di misura
- Range di misura del trasmettitore CP 115 sul range ± 2000 mbar a seconda dell'unità di misura

Esempio:

Da 0 a 750 mmH₂O, il range di misura è 750 mmH₂O.
Da -500 a +500 mbar, il range di misura è 1000 mbar.

Impostazione range standard / zero centrale – interruttore sinistro DIP

 Seguire attentamente le combinazioni con l'interruttore DIP. Se la combinazione viene eseguita in modo sbagliato, apparirà il seguente messaggio sul display del trasmettitore "CONF ERROR". In quel caso, dovrete scollegare il trasmettitore, posizionare gli interruttori DIP in modo corretto, quindi accendere il trasmettitore.

Configurazioni Scala completa Zero centrale

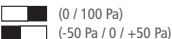

Esempio:

- De 0 - 100 Pa: scala completa / 0 Zero centrale
- 

Impostazione output – interruttore destro DIP (modelli CP 111/112/113/114/115 – AO e CP 111/112/113/114/115 – AN)

Per impostare questo tipo di output, posizionare l'interruttore dell'output come mostrato qui a fianco.

Configurazioni 4-20 mA 0-10 V



Impostazione unità – interruttore destro DIP

Per impostare l'unità di misura, posizionare gli interruttori delle unità 2, 3 e 4 come mostrato nella tavola qui sotto.

CP 111, CP 112, CP 113

Configurazioni	Pa	mmH ₂ O	mbar	InWG	mmHG	daPa	kPa	hPa
Combinazioni								

CP 114, CP 115

Configurazioni	mbar	inWG	kPa	PSI	mmHG	mmH ₂ O	daPa	hPa
Combinazioni								

Configurazione tramite il software LCC-S (opzione)

Configurazione facile e intuitiva con il software!
E' possibile configurare i range intermedi.

⚠ Attenzione: la differenza minima tra la scala minima e massima è di 20.

Per esempio, è possibile impostare lo strumento da -20 a 0 Pa, da 0 a +20 Pa, o da -10 a +10 Pa (CP 111/112/113) o da -20 a 0 mbar, da 0 a +20 mbar, o da -10 a +10 mbar (CP 114/115).

Per accedere alla configurazione tramite il software: impostare gli interruttori DIP come mostrato a fianco. Nota: l'interruttore on-off 1 dell'interruttore destro DIP può essere in qualsiasi posizione (selezione dell'output 0-10 V o 4-20 mA). Connettere il cavo del software LCC-S al trasmettitore.

⚠ La configurazione dei parametri può essere eseguita sia con l'interruttore DIP che tramite il software (non si possono combinare entrambe le soluzioni).

Montaggio

Per montare il trasmettitore, montare il retro di ABS al muro (trapano: \varnothing 6 mm, viti e punte sono forniti).

Inserire il trasmettitore alla piastra fissa (vedere A sul disegno qui a fianco). Ruotare la custodia in senso orario finché non udite un "click" che confermerà che il trasmettitore è installato correttamente.

⚠ Una volta che il trasmettitore è installato e acceso, eseguire un autozero per garantire il corretto funzionamento del trasmettitore in qualsiasi posizione.

Accessori

Per ulteriori informazioni sugli accessori disponibili, consultare la scheda tecnica.

Manutenzione: evitare i solventi aggressivi. Proteggere il trasmettitore e le sonde da qualsiasi tipo di prodotto per la pulizia che contenga formalina e che potrebbe essere utilizzato per la pulizia delle stanze o dei condotti.

Precauzioni d'uso: utilizzare sempre il dispositivo nel rispetto della sua destinazione d'uso e dei parametri descritti nelle caratteristiche tecniche al fine di non comprometterne la protezione dal dispositivo

Configurazione con PC

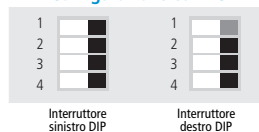

Fare riferimento al manuale d'uso di LCC-S per eseguire la configurazione.

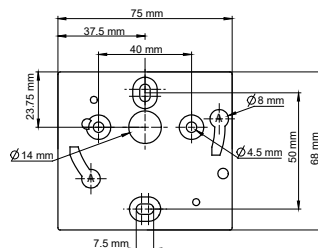

Schnellstartanleitung



Differentialdrucktransmitter



**Bereiche von -100/+100 Pa
bis -2000/+2000 mbar (je nach Modell)**



**Konfigurierbare
Zwischenbereiche**

Eigenschaften

- 0-10 V oder 4-20 mA Ausgang, aktiv, Spannungsversorgung 24 Vac/Vdc (3-4 Drähte) oder 4-20 mA Ausgang, passive Schleife, Spannungsversorgung von 16 bis 30 Vdc (2 Drähte)
- ABS V0 Gehäuse, IP65, mit oder ohne Display
- «¼-Drehung» Systemmontage mit Wandmontageplatte
- Gehäuse mit vereinfachtem Montagesystem
- Magnetventil für Auto-Kalibrierung (nur bei Modell CP 111)

Allgemeine Eigenschaften

Ausgang / Versorgung	Aktiver Sensor 0-10 V oder 4-20 mA (alim. 24 Vac/Vdc ±10%), 3-4 Drähte Passive Schleife 4-20 mA (Spannungsversorgung 16/30 Vdc), 2 Drähte Gleichtaktspannung <30 VAC Maximale Last: 500 Ω (4-20 mA) / Mindestlast: 1 K Ω (0-10 V)
Verbrauch	CP 111: 3 VA (0-10 V) oder 3 VA (4-20 mA) CP112, CP113, CP 114, CP 115: 2 VA (0-10 V) oder 0.6 VA (4-20 mA)
Europäische Richtlinien	2014/30/EU EMC; 2014/35/EU Niederspannung; 2011/65/EU RoHS II; 2012/19/EU WEEE
Elektrischer Anschluss	Schraubklemmenblock für Kabel von 0,05 bis 2,5 mm ² oder von 30 bis 14 AWG Ausgeführt nach dem Code of Good Practice
PC-Kommunikation	USB-Mini-DIN-Kabel
Umgebung	Luft und neutrale Gase
Reaktionszeit	1/e (63%) 0.3 s
Nullstellung	Manueller Autozero mit Druckknopf; Selbstkalibrierung durch Magnetventil (nur CP 111)
Art der Flüssigkeit	Luft und neutrale Gase
Verwendungsbedingungen (°C/%RH/m)	Von 0 bis +50 °C. Unter nicht kondensierenden Bedingungen. Von 0 bis 2000 m
Lagertemperatur	Von -10 bis +70 °C

*Alle in diesem technischen Datenblatt angegebenen Genauigkeiten wurden unter Laborbedingungen ermittelt und können für Messungen garantiert werden, die unter den gleichen Bedingungen oder mit Kalibrierungsausgleich durchgeführt werden.

Technische Daten

	CP 111	CP 112	CP 113	CP 114	CP 115
Messbereiche	-100/+100 Pa	-1000/+1000 Pa	-10000/+10000 Pa	-500/+500 mbar	-2000/+2000 mbar
Maßeinheiten	Pa, mmH ₂ O, inWG, mmHG, daPa, kPa, hPa, mbar	Pa, mmH ₂ O, inWG, mmHG, daPa, kPa, hPa, mbar	Pa, mmH ₂ O, inWG, mmHG, daPa, kPa, hPa, mbar	mbar, inWG, mmHG, PSI, mmH ₂ O, daPa, hPa, kPa	mbar, inWG, mmHG, PSI, mmH ₂ O, daPa, hPa, kPa
Genauigkeit*	±1% vom Messwert ±2 Pa	±1.5% vom Messwert ±3 Pa	±1.5% vom Messwert ±30 Pa	±1.5% vom Messwert ±3 mbar	±1.5% vom Messwert ±3 mbar
Auflösung	1 Pa; 0.1 mmH ₂ O; 0.01 mbar; 0.01 inWG; 0.01 mmHG; 0.1 daPa; 0.001 kPa; 0.01 hPa	1 Pa; 0.1 mmH ₂ O; 0.01 mbar; 0.01 inWG; 0.01 mmHG; 0.1 daPa; 0.001 kPa; 0.01 hPa	1 Pa; 0.1 mmH ₂ O; 0.01 mbar; 0.01 inWG; 0.01 mmHG; 0.1 daPa; 0.01 kPa; 0.01 hPa	1 mbar; 1 mmHG; 1 mmH ₂ O; 1 hPa; 10 daPa; 0.1 kPa; 0.1 PSI	1 mbar; 0.1 inWG; 1 mmHG; 1 mmH ₂ O; 1 hPa; 10 daPa; 0.1 kPa; 0.1 PSI
Tolerierter Überdruck	21 000 Pa	21 000 Pa	69 000 Pa	1400 mbar	4100 mbar

Eigenschaften des Gehäuses

Material	ABS V0 gemäß UL94
Schutzklasse	IP65
Display	LCD mit 10 Ziffern. Abmessungen: 50 x 17 mm Höhe der Ziffern: Werte: 10 mm; Einheiten: 5 mm
Verbindungen	Gerippt, Ø 6.2 mm
Kabelverschraubung	Für Kabel mit einem Durchmesser von maximal 8 mm
Gewicht	143 g

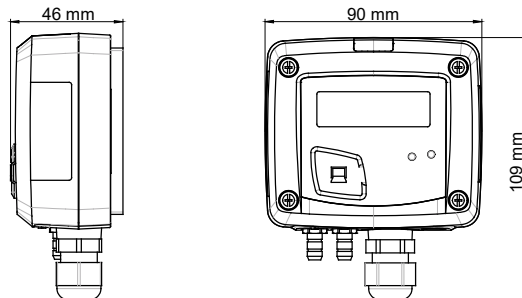

Verwendete Symbole

Zu Ihrer Sicherheit und um Schäden am Gerät zu vermeiden, befolgen Sie bitte die in diesem Dokument beschriebene Vorgehensweise und lesen Sie die mit dem folgenden Symbol gekennzeichneten Hinweise aufmerksam durch:

Das folgende Symbol wird auch in diesem Dokument verwendet, bitte lesen Sie die Hinweise nach diesem Symbol sorgfältig durch:



Verbindungen

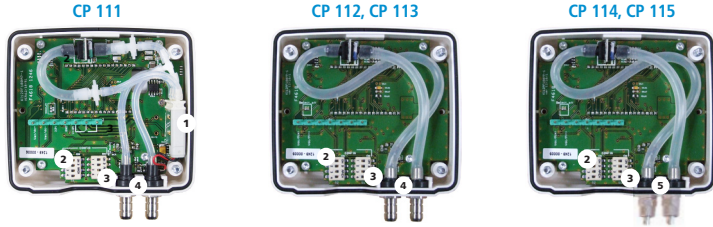

Innenseite des vorderen Gehäuses

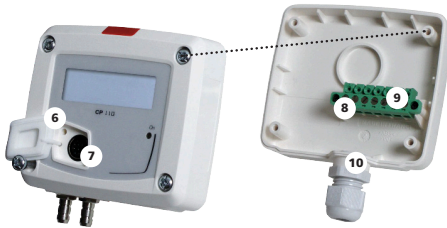

Abnehmbare Vorderseite

Gehäuse mit fester Rückseite

1. Magnetventil (nur CP 111)
2. Linker DIP-Schalter
3. Rechter DIP-Schalter
4. Druckanschlüsse
5. Sicherheitsdruckanschlüsse
6. Autozero
7. LCC-S Software-Anbindung
8. Ausgangs-Klemmleiste
9. Klemmenleiste für die Stromversorgung
10. Kabelverschraubung

Elektrische Anschlüsse nach NFC15-100 Standard



Dieser Anschluss muss von einem qualifizierten und geschulten Techniker vorgenommen werden. Um die Verbindung herzustellen, darf der Transmitter NICHT UNTER STROM stehen.

Für die Modelle CP 111/112/113/114/115 - AO und CP 111/112/113/114/115 - AN mit 0-10 V oder 4-20 mA Ausgang - aktiv, 4 Drähte:

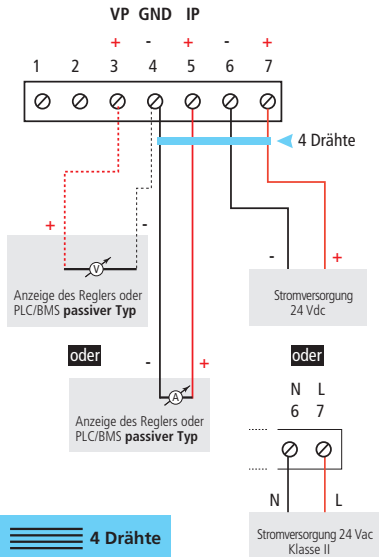

Um eine 3-Draht-Verbindung herzustellen, verbinden Sie bitte vor dem Einschalten des Transmitters die Ausgangsmasse mit der Eingangsmasse. Siehe Zeichnung unten.

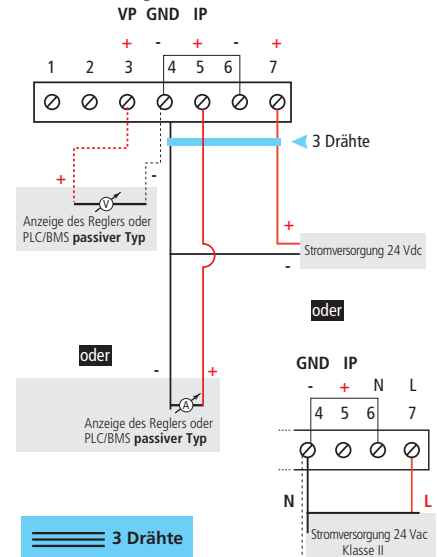

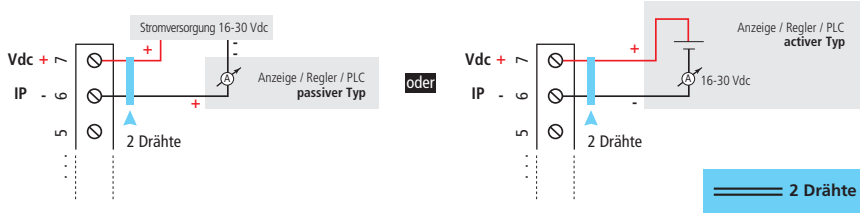

Einstellungen und Verwendung des Transmitters

Auto-Kalibrierung

Der CP 111 Drucktransmitter verfügt über eine Temperaturkompensation der Verstärkung von 0 bis 50°C und einen Autokalibrierungsprozess, der im Laufe der Zeit eine ausgezeichnete Stabilität und eine perfekte Zuverlässigkeit der Messung in niedrigen und hohen Bereichen garantiert.

Selbstkalibrierungsprinzip: Der Mikroprozessor des Transmitters steuert ein Magnetventil, das die möglichen Abweichungen des empfindlichen Elements im Laufe der Zeit kompensiert. Die Kompensation erfolgt durch



Um den Transmitter zu konfigurieren, darf er nicht unter Spannung stehen. Dann können Sie die erforderlichen Einstellungen mit den DIP-Schaltern vornehmen (wie in der Zeichnung unten dargestellt). Wenn der Transmitter konfiguriert ist, können Sie ihn einschalten.

die permanente Einstellung des Nullpunkts. Somit ist die Messung des Differenzdrucks unabhängig von den Umgebungsbedingungen des Transmitters.

Vorteil: keine Drift
Häufigkeit der Selbstkalibrierung: rücksetzbar oder von 1 bis 60 Minuten.

Autozero

Um einen Autozero durchzuführen, ziehen Sie die 2 Druckanschlüsse ab und drücken Sie die Taste "Autozero". Beim Transmitter CP 111 ist es nicht erforderlich, die beiden

Druckanschlüsse zu entfernen. Wenn ein Autozero durchgeführt wurde, schaltet sich das grüne Licht "On" aus und dann wieder ein, und bei Transmittern, die mit einem Display ausgestattet sind, wird "autoZ" angezeigt.

Konfiguration

Um den Transmitter zu konfigurieren, schrauben Sie die 4 Schrauben vom Gehäuse ab und öffnen es. Die DIP-Schalter für die verschiedenen Einstellungen sind dann zugänglich.

Linker DIP-Schalter

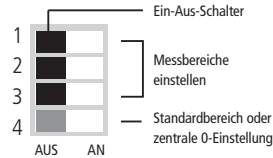

Rechter DIP-Schalter

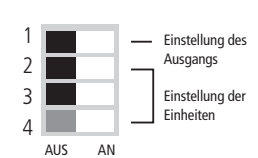

Messbereichseinstellungen - linker DIP-Schalter

Um einen Messbereich einzustellen, schalten Sie die Schalter 1, 2 und 3 wie in der Tabelle unten angegeben ein und aus.

CP 111, CP 112, CP 113

Transmitter-Typ	Kombination 1			Kombination 2			Kombination 3			Kombination 4			Kombination 5		
	CP111	CP112	CP113	CP111	CP112	CP113	CP111	CP112	CP113	CP112	CP111	CP113	CP111	CP112	CP113
Pa	20	100	1000	30	250	2500	40	500	5000	50	750	7500	100	1000	10000
mmH ₂ O	2.0	10.0	100.0	3.0	25.0	250.0	4.0	50.0	500	5.0	75.0	750.0	10.0	100.0	1000.0
mbar	0.20	1.00	10.00	0.30	2.50	50.00	0.40	5.00	50.00	0.50	7.50	75.00	1.00	10.00	100.00
inWG	0.08	0.40	4.00	0.12	1.00	10.00	0.16	2.00	20.00	0.20	3.00	30.00	0.40	4.00	40.00
mmHg	0.20	0.80	8.00	0.22	2.00	20.00	0.30	4.00	40.00	0.40	6.00	60.00	0.80	8.00	80.00
daPa	2.0	10.0	100	3.0	25.0	250.0	4.0	50.0	500.0	5.0	75.0	750.0	10.0	100.0	1000.0
kPa	0.020	0.100	1.00	0.030	0.250	2.50	0.040	0.500	5.00	0.050	0.750	7.50	0.100	1.000	10.00
hPa	0.20	1.00	10.00	0.30	2.50	25.00	0.40	5.00	50.00	0.50	7.50	75.00	1.00	10.00	100.00

- Messbereiche des Transmitters CP 111 im Bereich ± 100 Pa je nach Messeinheit
- Messbereiche des Transmitters CP 112 im Bereich von ± 1000 Pa je nach Messeinheit
- Messbereiche des Transmitters CP 113 im Bereich $\pm 10\,000$ Pa je nach Messeinheit

Beispiel:

- Von 0 bis 750 mmH₂O, Messbereich ist 750 mmH₂O
- Von -500 Pa bis +500 Pa, Messbereich ist 1000 Pa

CP 114, CP 115

	Kombination 1		Kombination 2		Kombination 3		Kombination 4		Kombination 5	
Transmitter-Typ	CP114	CP115	CP114	CP115	CP114	CP115	CP114	CP115	CP114	CP115
mbar	100	500	200	750	300	1 000	400	1 500	500	2 000
inWG	40.0	200.0	80.0	300.0	120.0	400.0	160.0	600.0	200.0	800.0
kPa	10.0	50.0	20.0	75.0	30.0	100.0	40.0	150.0	50.0	200.0
PSI	2.0	10.0	4.0	15.0	6.0	20.0	8.0	30.0	10.0	40.0
mmHg	80	400	160	600	240	800	320	1 200	400	1 600
mmH ₂ O	1 000	5 000	2 000	7 500	3 000	10 000	4 000	15 000	5 000	20 000
daPa	1.0	5.0	2.0	7.5	3.0	10.0	4.0	15.0	5.0	20.0
hPa	100	500	200	750	300	1 000	400	1 500	500	2 000

- Messbereiche des CP 114 Transmitters im Bereich von ± 500 mbar je nach Messeinheit.
- Messbereiche des CP 115 Transmitters im Bereich von ± 2000 mbar je nach Messeinheit.

Beispiel:

- Von 0 bis 750 mmH₂O, Messbereich ist 750 mmH₂O
- Von -500 mbar bis +500 mbar, Messbereich ist 1000 mbar

Standardbereich / zentrale Nullstellung - linker DIP-Schalter

 Bitte beachten Sie die nebenstehenden Kombinationen mit dem DIP-Schalter. Wird die Kombination falsch vorgenommen, erscheint auf dem Display des Transmitters die Meldung "CONF ERROR". In diesem Fall müssen Sie den Transmitter ausstecken, die DIP-Schalter richtig einstellen und dann den Transmitter einschalten.



	Einstellungen	Originalgröße	Zentraler Nullpunkt
Kombinationen			

Beispiel:

- 0 - 100 Pa: Originalgröße / 0  (0 / 100 Pa)
- Zentraler Nullpunkt  (-50 Pa / 0 / +50 Pa)

Ausgangseinstellung - rechter DIP-Schalter (CP 111/112/113/114/115 –AO und CP 111/112/113 –AN Modelle)

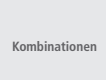







Um den Typ des Analogausgangs einzustellen, stellen Sie bitte den Ein-Aus-Schalter des Ausgangs wie nebenstehend gezeigt ein.

	Einstellungen	4-20 mA	0-10 V
Kombinationen			









Einstellung der Einheiten - rechter DIP-Schalter

Um eine Messeinheit einzustellen, stellen Sie die Ein-Aus-Schalter 2, 3 und 4 der Einheiten wie in der Tabelle unten gezeigt ein.

CP 111, CP 112, CP 113

Einstellungen	Pa	mmH ₂ O	mbar	inWG	mmHG	daPa	kPa	hPa
Kombinationen								

CP 114, CP 115

Einstellungen	mbar	inWG	kPa	PSI	mmHG	mmH ₂ O	daPa	hPa
Kombinationen								

Konfiguration über LCC-S Software (Option)

Eine einfache und komfortable Konfiguration mit der Software!
Sie können Ihre eigenen Zwischenbereiche konfigurieren.

⚠ Der Mindestabstand zwischen dem oberen und dem unteren Bereich beträgt 20.

Es ist zum Beispiel möglich, das Gerät von -20 bis 0 Pa, von 0 bis +20 Pa oder von -10 bis +10 Pa einzustellen... Für den Zugriff auf die Konfiguration über die Software: stellen Sie die DIP-Schalter wie nebenstehend gezeigt ein. Hinweis: Der Ein-Aus-Schalter 1 des rechten DIP-Schalters kann sich in einer beliebigen Position befinden (Auswahl des Analogausgangs 0-10 V oder 4-20 mA). Schließen Sie das Kabel des LCC-S an den Anschluss des Transmitters an.

⚠ Die Konfiguration der Parameter kann entweder über den DIP-Schalter oder über die Software erfolgen (eine Kombination beider Lösungen ist nicht möglich).

Montage

Zur Montage des Transmitters befestigen Sie die ABS-Platte an der Wand (Bohrung: $\varnothing 6$ mm, Schrauben und Stifte werden mitgeliefert). Setzen Sie den Transmitter auf die Befestigungsplatte (siehe A in der nebenstehenden Zeichnung). Drehen Sie das Gehäuse im Uhrzeigersinn, bis Sie ein "Klicken" hören, das bestätigt, dass der Transmitter korrekt installiert ist.

⚠ Sobald der Transmitter installiert und eingeschaltet ist, führen Sie bitte einen Autozero durch, um das korrekte Funktionieren des Transmitters in jeder Position zu gewährleisten.

Zubehör

Weitere Informationen über das verfügbare Zubehör entnehmen Sie bitte dem Datenblatt.

Wartung: Vermeiden Sie bitte alle aggressiven Lösungsmittel. Schützen Sie den Transmitter und seine Sonden vor formalinhaltigen Reinigungsmitteln, die zur Reinigung von Räumen oder Kanälen verwendet werden können.

Vorsichtsmaßnahmen für die Verwendung: bitte verwenden sie das Gerät immer in Übereinstimmung mit seiner bestimmungsgemäßen Verwendung und innerhalb der in den technischen Merkmalen beschriebenen Parameter, um den durch das Gerät gewährleisteten Schutz nicht zu gefährden.

Konfiguration via PC

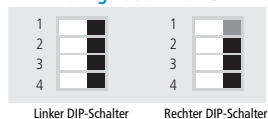

Linker DIP-Schalter

Rechter DIP-Schalter

[Lesen Sie die Gebrauchsanweisung des LCC-S, um die Konfiguration vorzunehmen.](#)

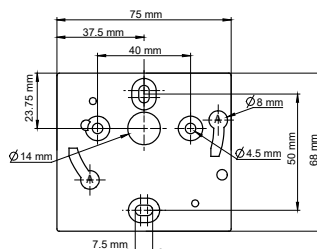



Download the LCC-S software user manual
Télécharger la notice d'utilisation du logiciel LCC-S
Descargue el manual de usuario del software LCC-S
Scarica il manuale d'uso del software LCC-S
Download der Gebrauchsanweisung für die LCC-S Software

Download the CP 110 data sheet
Télécharger la fiche technique du CP 110
Descargue la ficha técnica del CP 110
Scarica la scheda tecnica del CP 110
Laden Sie das Datenblatt zum CP 110 herunter



Customer service portal / Portail service clients Portal de servicio al cliente / Portale servizio clienti/ Kundenserviceportal

Utilisez notre Portail service clients pour nous contacter
Use our Customer service portal to contact us
Contacte con nosotros a través del Portal de servicio al cliente
Utilizzate il nostro Portale servizio clienti per contattarci
Nutzen Sie unser Kundenservice-Portal, um mit uns Kontakt aufzunehmen

<https://sauermann-en.custhelp.com>

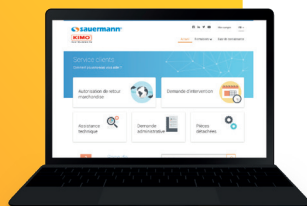

FR
Cet appareil
et ses accessoires
se recyclent

À DÉPOSER
EN MAGASIN

À DÉPOSER
EN DÉCHÈTERIE

OU

Points de collecte sur www.quefairedemesdechets.fr
Privilégiez la réparation ou le don de votre appareil !