

**USER MANUAL**

Si-CA 8500

**PORTABLE INDUSTRIAL COMBUSTION  
FLUE GAS & EMISSIONS ANALYZER**

# TABLE OF CONTENTS

<b>ANALYZER OPTIONS</b> .....	4
CHAPTER 1 - FUNDAMENTALS.....	5
CHAPTER 2 - THE INSTRUMENT KEYBOARD.....	10
CHAPTER 3 - BASIC INSTRUMENT OPERATION.....	11
CHAPTER 4 - POWER REQUIREMENTS.....	13
CHAPTER 5 - SAMPLE FLOW & SAMPLE CONDITIONING SYSTEM.....	14
CHAPTER 6 - SENSORS.....	18
CHAPTER 7 - ANALYZER SETUP .....	22
CHAPTER 8 - INTERNAL DATA STORAGE.....	26
CHAPTER 9 - WIRELESS REMOTE PRINTER .....	28
CHAPTER 10 - CALIBRATION.....	30
CHAPTER 11 - COMMUNICATIONS .....	35
CHAPTER 12 - MAINTENANCE .....	36
APPENDIX A - Si-CA 8500 - SPECIFICATIONS .....	39
APPENDIX B - FIRMWARE PROGRAMMING.....	42
APPENDIX C - REPLACEMENT PARTS .....	43
APPENDIX D - CONTACT.....	43

## LIST OF ABBREVIATIONS

### PARAMETERS

<b>AIR</b>	Excess air
<b>CO</b>	Carbon monoxide (a toxic gas)
<b>CO<sub>2</sub></b>	Carbon dioxide – NDIR measurement OR calculated from O <sub>2</sub>
<b>DFT</b>	Draft/Pressure
<b>DUTY</b>	Duty cycle is a power setting given in percent
<b>EFF</b>	Combustion efficiency (for boilers and furnaces, does not apply to engines)
<b>HC</b>	Hydrocarbons (NDIR) measurement – (HC is same as CxHy)
<b>H<sub>2</sub>S</b>	Hydrogen Sulfide (a toxic gas)
<b>N.A.</b>	Parameter not available
<b>NO</b>	Nitric oxide (a toxic gas)
<b>NO<sub>2</sub></b>	Nitrogen dioxide (a toxic gas)
<b>NO<sub>x</sub></b>	Oxides of nitrogen (a toxic mixture of NO & NO <sub>2</sub> gases)
<b>O<sub>2</sub> REF</b>	Oxygen reference basis for correction of toxic gas concentrations
<b>SO<sub>2</sub></b>	Sulfur dioxide (a toxic gas)
<b>Ta</b>	Ambient (room) temperature
<b>Tp</b>	Preheated Air temperature
<b>Tg</b>	Gas temperature
<b>THERMAL EFF</b>	Engine thermal efficiency (heat loss method of calculation, not the same as combustion efficiency)
<b>VEL</b>	Stack Gas Velocity
<b>VOC</b>	Volatile Organic Compounds

### UNITS

<b>CFM</b>	Cubic feet per minute, (volumetric stack gas flow-rate)
<b>CMM</b>	Cubic meters per minute, (volumetric stack gas flow-rate)
<b>FPS</b>	Feet per second (stack gas velocity measurement)
<b>MPS</b>	Meters per second (stack gas velocity measurement)
<b>#/H</b>	Pounds (of pollutant) per hour (mass emissions)
<b>T/D</b>	Tons per day (mass emissions)
<b>PPM</b>	Parts (of pollutant) per million (volume basis-dry)
<b>MGM</b>	Milligrams (of pollutant) per cubic meter
<b>GBH</b>	Grams (of pollutant) per (engine) brake horsepower-hour.
<b>#/B</b>	Pounds (of pollutant) per million BTU (of fuel).
<b>"WC</b>	Inches of water (draft/pressure measurement)
<b>mmWC</b>	Millimeters of water (draft/pressure measurement)
<b>kPa</b>	KiloPascals (draft/pressure measurement)
<b>mbar</b>	Millibars (draft/pressure measurement)
<b>%</b>	Percent by volume, dry-basis
<b>in<sup>2</sup></b>	Square inches (cross sectional area of stack)
<b>cm<sup>2</sup></b>	Square centimeters (cross sectional area of stack)

## ANALYZER OPTIONS

The Sauermann Si-CA 8500 is an extremely versatile emissions measurement system that meets practically all emissions requirements. It has been designed as a modular system, permitting the installation, in the field, of most of the various available options. This manual describes the complete instrument equipped with all the options.

Si-CA 8500 standard capabilities include 300 mm/12" stainless steel probe (800°C/1470°F max.) with dual hose sampling line, ambient and stack temperature measurements, O<sub>2</sub> & CO electrochemical gas sensors, dilution pump and electronic valve for dual range CO and purging capability, draft & differential pressure measurements, 2000 internal storage tags, wireless remote printer (optional), Bluetooth® wireless PC communications, EGAS Windows software, custom fuel programming option, and extensive help screens. The available options are separated into two categories:

### 1. GAS SENSORS

- Oxygen (O<sub>2</sub>) sensor – 5-Series electrochemical sensor
- Carbon Monoxide (CO) sensor – 5-Series electrochemical sensor
- Nitric Oxide (NO) sensor – 5-Series electrochemical sensor
- Nitrogen dioxide (NO<sub>2</sub>) sensor – 5-Series electrochemical sensor
- Sulfur dioxide (SO<sub>2</sub>) sensor – 5-Series electrochemical sensor
- Hydrogen sulfide (H<sub>2</sub>S) sensor – 4-Series electrochemical sensor
- Carbon dioxide (CO<sub>2</sub>) – non-dispersive infrared (NDIR) sensor
- Hydrocarbon (C<sub>x</sub>H<sub>y</sub> or HC) – non-dispersive infrared (NDIR) sensor
- High Carbon monoxide (CO) – non-dispersive infrared (NDIR) sensor
- Volatile Organic Compounds (VOC) – PID (photo-ionization) sensor

### 2. SAMPLE EXTRACTION & TRANSPORT SYSTEMS

- A. Stainless steel probe with dual hose sample line (800°C/1470°F max.) in probe lengths of 300 mm/12" (standard) or 750 mm/30" (optional)
- B. Inconel probe (1200°C/2200°F max.) with 3 m/10' sample line in various probe lengths

## CHAPTER 1 - FUNDAMENTALS

---

The Si-CA 8500 Integrated Emissions System is a portable state of the art analyzer designed to measure, record and remotely transmit combustion parameters used for the following tasks:

1. To measure the oxide of nitrogen emissions from stationary combustion sources by means of electrochemical sensors in accordance with the EPA Provisional Reference Method (EMTIC CTM-022, CTM-030, & CTM-034) for portable NO<sub>x</sub> analyzers.
  2. To measure the emissions of carbon monoxide, sulfur dioxide and oxygen sources from stationary and mobile combustion sources by means of electrochemical sensors.
  3. To use NDIR technology to measure simultaneously, gaseous hydrocarbons as methane, carbon monoxide, and carbon dioxide. **The Si-CA 8500 Meets EPA's Reference Method 25B Appendix A 40CFR60 "Determination of Total Gaseous Organic Concentration Using a Nondispersive Infrared Analyzer"**.
  4. To compute the emission rates in lbs/million BTU or lbs/hour (mass emissions) for carbon monoxide, NO<sub>x</sub> and sulfur dioxide, and in tons/day for carbon dioxide according to the EPA's 40CFR75 regulations for continuous emissions monitoring.
  5. To measure the stack gas velocity and volumetric flow rate and emission rates according to the **EPA Method 2, or Method 2C, Appendix A of 40CFR60**.
  6. To assist the operator of a combustion source with the task of optimizing its efficiency, performance, and fuel savings.
  7. To be used as a management tool to assist the plant manager with keeping records and controlling costs.
- Reading may be affected if the unit is operated within the immediate proximity of electromagnetic frequency field of approximately 3 volts per meter, but the performance of the instrument will not be permanently affected.
  - Recommended Operating Temperature: -5 to +45°C (23 to 113°F)
  - Recommended Operating Relative Humidity: 15%RH to 85%RH
  - Recommended Storage Temperature: -10 to +50°C (14 to 122°F)
  - Supply Voltage: 100-240 VAC
  - Frequency Range: 50-60 Hz
  - Power Rating: 25 W
  - Ingress Protection (IP) Rating: IP40

The Si-CA 8500 also uses the best available compact conditioning system technology with a proprietary battery operated thermoelectric chiller for accurate transport of the sample gas to the instrument. It also uses sophisticated electronics and programming design for increased accuracy and flexibility. It measures 3 temperatures and 9 different stack gases. It calculates efficiency of combustion as well as excess air and carbon dioxide. In addition, it can compute emissions in five different systems of units (PPM, milligrams/m<sup>3</sup>, lbs/MMBTU, grams/brake horsepower-hour, and lbs/hour). It stores, prints and graphs data. It communicates with a variety of other computers, tablets, and other Windows compatible devices located nearby using Bluetooth® wireless technology. It has a library of 15 fuels. It is designed to operate on its internal rechargeable battery pack as well as AC power.

## Exclusions and restrictions of liability

The application operation is under the exclusive customer or user entity responsibility, who acknowledges using this system at his/her own risks. The customer or user entity explicitly exclude Sauermann, and every other company through which the it could have been sold of any kind of responsibility or warranty regarding any direct, indirect, accidental, consecutive or nonconsecutive damage that could have been subjected, for some or all, by partial or total non-respect, voluntary or involuntary, of recommendations, conditions and prerequisites indicated hereafter.

## Environment protection:



Send back the device at its end of working life in a waste collection centre for electrical and electronic components (according to local regulations) or send it back to Sauermann to ensure a required waste collection in the respect of the environment.

## Symbols used:

For your safety and in order to avoid any damage of the device, please follow the procedure described in this user manual and read carefully the notes preceded by the following symbol:



The following symbol will also be used in this user manual:



Please read carefully the information notes indicated after this symbol.

## The basic operation is as follows:

You insert the extraction probe in the stack of an operating combustion source such as a boiler, furnace, or combustion engine. A pump located inside the instrument draws a small sample of the stack gas. The gas sensors analyze the contents of the stack gas and its temperature and calculate & display the results. In addition, an optional Pitot tube measures the velocity of the stack gases, which allows for mass emissions calculations. The results can also be stored in memory, printed out, or sent remotely to a computer using the Bluetooth® wireless communications. The source operator can make the required adjustments on the combustion source based on the analysis of the stack conditions to optimize performance of the combustion source.

## A. UNPACKING THE INSTRUMENT

Every Si-CA 8500 includes as standard equipment:

- The Si-CA 8500 Emissions Analyzer with integrated chiller conditioning system and automatic condensate drain
- Stack sampling probe that includes the probe shaft, sample line/hose, and thermocouple cable/connector (probe must be ordered as a separate item, it is not part of the Si-CA 8500 base unit)
- Battery charger/AC adaptor for the analyzer
- EGAS Software for Windows on USB Flash Drive
- Bluetooth® module (internal)
- USB Communications Cable
- Protective carrying case with shoulder strap
- Calibration certificate
- Instruction manual on USB Flash Drive

## B. Si-CA 8500 STARTING INSTRUCTIONS

1. Make sure the instrument is in a clean-air, room-temperature environment and turn it on by pressing the **POWER** button on the keypad.

2. Press the **OK** button to begin an autozero countdown. Once the display shows **AUTOZERO COMPLETE**, you are ready to use the instrument for your measurements. You can also initiate the autozero the analyzer by first pressing the **CALIB** button. The cursor will rest on the first line of the display, which states **Zero All Sensors**. Press **OK**. The display will automatically switch to the **MEASURE** mode and the last line will execute a countdown. At the end of the countdown you are ready to use the instrument.
3. If, at the end of the autozero countdown, the display shows an error message for a particular sensor, see the troubleshooting table in section D of this chapter. The instrument will measure correctly all sensors that do not show an error message.
4. With the analyzer in its case, connect the probe to the unit. One hose with the quick disconnect fitting connects to the "Sample In" port, and the other hose connects to the "+" pressure port. The thermocouple connector plugs into the "Stack" temperature connector. For the most accurate draft measurements, another autozero calibration should be done (through the CALIBRATION button menu) after the probe & hoses are fully connected to the analyzer but before the probe is inserted into the stack.
5. The instrument can have up to six electrochemical gas sensors, one PID sensor, and three infrared (NDIR) gas sensors. The Si-CA 8500 has three temperature sensors total.
6. All sensor readings are single range readings with ranges listed in Appendix A. The CO reading is an exception. If the CO concentration exceeds the "Dilute CO" threshold that can be adjusted in the SETUP menu, a CO dilution takes place automatically to increase the CO dilution measurement range to as high as 20000 ppm. If the measured CO concentration exceeds the upper end of the set dilution range, then a CO purge mode is initiated. If any of the ranges are exceeded for the other sensors the corresponding parameter will read OVER on the display. In that case, it is strongly recommended to withdraw the probe from the stack immediately and let the analyzer run with the pump on in a clean air environment to prevent sensor saturation.



**NOTE:** For CO measurements greater than 20000 ppm, the optional CO NDIR sensor can measure up to 15% CO.

7. Interior or exterior use. Protect the device from moisture and rain.
8. Only accessories which meet the manufacturer's specifications shall be used.
9. The charger must be exclusively used for this Sauer mann product. Using a different charger type may damage the analyzer.
10. This device has been developed, produced and sold exclusively to trained and qualified experts in the field of emissions monitoring. Appropriate training is necessary in order to guarantee a riskless use of this instrument. Sauer mann is not responsible for any possible accidents during its use.
11. The device must not be used in ATEX zones according to applicable standards.
12. Do not use the device next to explosive gases, vapors, or dust.
13. Do not block ventilation holes of the instrument.
14. Do not authorise pressures beyond the device limits. Please refer to the technical features described in this user manual.
15. Be careful when removing gas sampling probe from the stack or pipe as it may be hot. A hot probe can cause burns.
16. Allow the probe to cool down and the device to operate in clean air before storing the probe.
17. Clean the product with a dry and clean cloth after each use.
18. To avoid any risk due to voltage on the surface of the probe, it is important that the thermocouple is not subjected to a voltage.
19. Any servicing must be carried out by a trained and qualified technician. The device power supply must be turned off.

20. The power to the instrument is turned off by disconnecting the external power supply.
21. Do not use the device if it is damaged or if it operates abnormally. Inspect the device before every use. In case of doubt, please contact Sauermann after-sales service.

### C. SAFETY GUIDELINES & ADVICE

Most stack gases are hot, full of moisture, corrosive, and laden with soot particles.

To make sure that your instrument will give you a long time of trouble-free performance, please observe the following recommendations.

1. Follow the instructions in the Si-CA 8500 manual.
2. Never use the instrument without the disposable fiber soot line filter or the condensation disk filter, which are located inside the analyzer. Operating the instrument without the filters will put the analyzer at high risk to damage the pump and sensors. These filters should be replaced as needed.
3. The built-in thermoelectric chiller removes moisture from the stack gas as it enters the analyzer, and the automatic condensate drain pump sends accumulate condensate out the bottom of the analyzer. It is best to let the Si-CA 8500 run with the main gas pump on for at least a few minutes after measuring is done to let all of the condensate automatically drain out of the analyzer and to also fully purge the stack gases out of the unit.
4. Do not expose the probe tip to open flame.
5. Do not rest the stack probe's sampling line on a hot boiler surface.
6. Allow the probe tip to cool off and the instrument to aspirate clean air before packing the probe.
7. It is strongly recommended to use single span calibration gas mixtures, preferably with balance nitrogen when calibrating the sensors for the most precise calibrations.
8. Keep the analyzer upright in the protective carrying case with the LCD display facing up for best operations of the unit.



**WARNING: Never lay the Si-CA 8500 on its side with the display screen & keypad upside down.**

9. If the analyzer enclosure is ever unscrewed and taken apart, be careful when pulling the top piece off the bottom piece because there is a ground wire connecting the two main pieces. Do not over-tighten the screws that hold the two main enclosure pieces together.

### D. AUTOZERO ERRORS & BASIC TROUBLESHOOTING

AUTOZERO ERRORS		
Channel	Possible Causes	Resolution
(Electrochemical sensors)	Sensor has been recently exposed to gas and has not yet returned to zero.	Purge for 10 minutes, monitor sensor voltage, and re-zero.
CO	Battery was dead, sensor has destabilized.	Charge battery, wait up to 24 hours for sensors to stabilize, and re-zero.
NO		
NO <sub>2</sub>		
SO <sub>2</sub>		
H <sub>2</sub> S		
O <sub>2</sub>	Sensor cell is dead.	Call for a replacement.
T Stack	Thermocouple is not connected	Check electrical connections running to the probe
	Thermocouple was hot	Probe tip should be cool



Stack Draft	Probe not connected	Draft voltage will be high. Connect probe and re-zero or ignore draft readings.
	Filters are dirty	Draft voltage will be low. Check filters
Infrared CO-CO <sub>2</sub> -HC 00	No response from infrared system	Autozero period must be at least 60 seconds. Zero the instrument again.
Infrared CO-CO <sub>2</sub> -HC XX	Infrared system is reporting error code XX	Infrared system may need maintenance.
Velocity	Velocity probe is not connected	Check probe and connections.
Flow (low)	Filters are clogged and/or wet	Replace filters as needed
Flow (high)	Gas exhaust at bottom of unit blocked	Unblock exhaust and check all hoses
<b>TROUBLESHOOTING</b>		
<b>Symptoms</b>	<b>Possible Causes</b>	<b>Resolution</b>
Analyzer will not turn on. (Screen is off)	Battery is dead.	Plug in the charger. Analyzer should turn on.
	Battery is not charging.	Check the charger and jack. Check the case for excessive heat.
	Internal initialization problem.	Reset the analyzer.
Analyzer turns on but screen is blue or faded.	Internal initialization problem.	Reset the analyzer.
	Analyzer is overheating.	Unplug charger. Check fan. Turn on & off to reinitialize.
Analyzer locks up or will not turn off properly.	Internal initialization or power problem.	Reset the analyzer.
Display Screen shows "Connect Charger"	Battery is completely discharged. No power to analyzer.	Connect charger to analyzer. Confirm charger provides 12V output.
"Low Flow" on display screen	Filters are clogged and/or wet	Check & replace filters inside analyzer as needed
	Probe/Hoses are blocked or pinched	Check probe & hoses
"High Flow" on display screen	Gas exhaust at bottom of analyzer is blocked	Check exhaust hose to make sure it is not blocked or clogged

**NOTE:** The reset button is located on the bottom of the analyzer approximately 4 cm (1.5") from one of the four black feet as shown in the photo below. You will need a pen tip or other small object to press the reset button. Make sure the charger is disconnected from the analyzer when pushing the reset button.

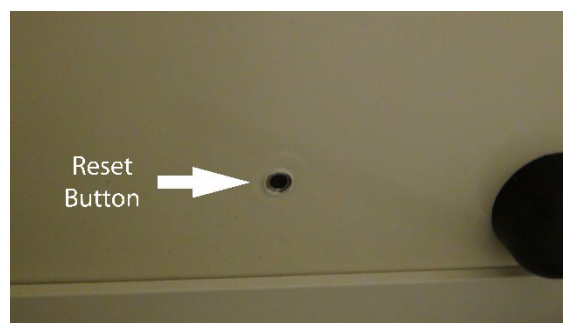

If the device is damaged or if it operates abnormally, please contact the Sauer mann's After-sales service : <https://sauermann.fr>

## CHAPTER 2 - THE INSTRUMENT KEYBOARD

---

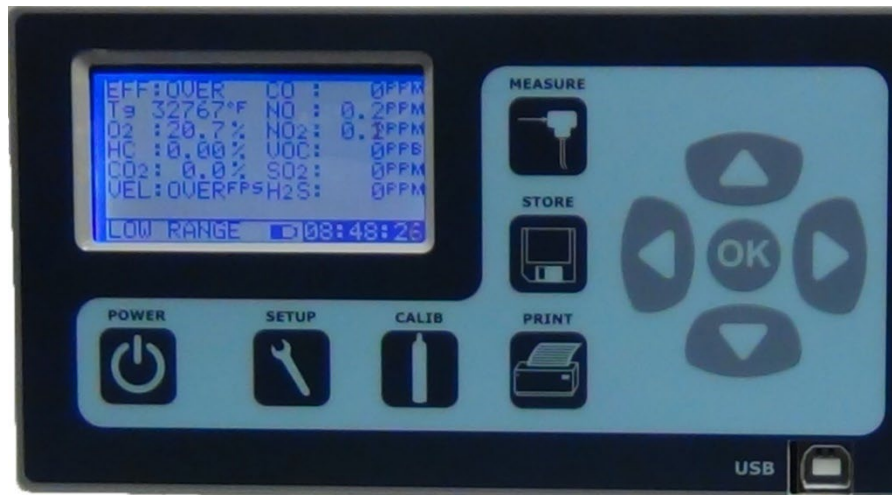

A brief explanation of the instrument's buttons is as follows:

- |                |  |
|----------------|--|
| <b>CALIB</b>   | Controls calibration settings and zeroing of the analyzer's sensors.   |
| <b>SETUP</b>   | Controls all customization parameters (such as measurement units) for the analyzer   |
| <b>MEASURE</b> | Displays the analyzer's currently measured data in either of two fonts:<br>A. Small fonts (all data displayed simultaneously plus range indicated, battery condition and time)<br>B. Large fonts (four data parameters displayed simultaneously) |
| <b>POWER</b>   | Turns analyzer and conditioning system on and off  |
| <b>STORE</b>   | Controls operation of the analyzer's internal data storage   |
| <b>PRINT</b>   | Executes print commands for the analyzer's remote printer  |
| <b>OK</b>      | Used with the direction keys to change a setting or navigate the menus   |
| ▲              | Moves the cursor up or increments the entry marked by the cursor   |
| ▼              | Moves the cursor down or decrements the entry marked by the cursor   |
| ◀              | Moves the cursor to the left   |
| ▶              | Moves the cursor to the right  |

## CHAPTER 3 - BASIC INSTRUMENT OPERATION

It is possible to master the basic operation of the instrument in a few minutes by following the procedure outlined below. Please refer to the other sections of this manual for a description of the more advanced features.

The Si-CA 8500 emissions analyzer consists of the following three major components:

1. The probe sampling line, whose function is to extract the sample, sense the stack temperature and depending on the option measure the stack gas velocity
2. The conditioning system is located inside the analyzer and consists of the thermoelectric chiller, automatic condensate draining system, and filters
3. The main section of the analyzer that houses all the gas sensors, battery pack, and PC board

To operate the instrument, follow the steps outlined below.

1. Turn the Si-CA 8500 analyzer on. The instrument pump will immediately turn on and the logo of the company will appear. Press **OK** to run the autozero cycle.
2. Attach the probe and sampling line that is supplied with your analyzer. One hose connects to the Sample In connector, and the other hose connects to the positive (+) pressure connector. The thermocouple connector from the stack gas sampling probe should be connected to the Temperature 1 thermocouple connector on the analyzer.
3. If you are using the analyzer for the first time, press the **SETUP** key to set the appropriate parameters (i.e. fuel, units, etc.) for your application. See Chapter 7 for an explanation of each parameter. A table of the SETUP display is shown here.
4. Press the **MEASURE** key and check the unit's battery condition. The **MEASURE** key toggles between a small font and a large font screen. Select the small font screen.

```
OCT 1 '15 12:45:00
Fuel:      NATURL GAS
Temperature Units: F
Measure Units: PPM
Pressure Units: inWC
O2 Reference: TRUE
Pumps: OFF
Dilution Duty: 100%
Water Drain: 25min
Chiller Duty: 75%
Dilute CO: 5000 PPM
Use CO-IR: 7000 PPM
Thermal Eff: 0.30
Display Contrast: 24
Baudrate: 9.6 kbps
Version: 1.00
Battery: x.xx V
```

```
EFF:xx.x% CO: XXXXPPM
Tg: xxxx°F NOx:XXXXPPM
O2: xx.x% NO: XXXXPPM
HC:xx.xx% NO2: XXXPPM
CO2:xx.x% SO2: XXXPPM
DFT:xx.x" H2S: XXXPPM

LOW RANGE  12:45:00
```

The battery icon is displayed in the middle of the bottom line of the display. Its condition is marked by the shaded fraction of the icon. If the unit is powered by the battery charger a small "plug" icon will replace the battery icon.

**NOTE:** When connecting the battery charger to the analyzer make sure that the "plug" icon appears on the **MEASURE** screen. This ensures a proper power connection and charging of the batteries.



**NOTE:** Depending on the options enabled for your analyzer some of the entries in one or more of the displays shown above will be blank if that option is not available.

5. After making sure that the analyzer is drawing clean air at room temperature, press the **CALIB** key. The cursor (reverse color) will point to the line:

Zero All Sensors

Press the **OK** key to execute an autozero cycle of all the sensors.

6. At the end of the autozero period, all sensors should indicate zero reading with the exception of the oxygen sensor, which should read 20.9% (the concentration of ambient dry air), and the stack temperature, which should correspond approximately to the room temperature.
7. Insert the analyzer's probe into the stack or engine exhaust. Use the MEASURE key to read the stack parameters.
8. From SETUP menu, in PUMP, display pump status:
  - a. AUTO - Automatic sample and dilution control mode is selected, and typical flow-rate is shown.
  - b. SAMPLE - Pump remains in sample mode (dilution disabled), and the current duty cycle of the pump is shown.
  - c. DILUTE - Pump remains in dilution mode, and the current duty cycle of the pump is shown.
  - d. PURGE – Purge mode is enabled, and the sample pump is turned off.
  - e. OFF – All pumps are turned off.
9. To obtain a printout of the data displayed, press the PRINT key. The cursor (reverse color) will point to:

Print Test Record

Press the OK key to execute a printout on the Si-CA 8500 remote printer.

10. Measured data can be stored in the analyzer's internal memory. Please refer to Chapter 8 for more details about data storage.
11. When you are finished with your measurements, withdraw the probe from the stack, allow the analyzer to draw clean ambient air for several minutes and for the probe to cool down, before packing the analyzer in its carrying case.

## CHAPTER 4 - POWER REQUIREMENTS

---

The Si-CA 8500 can run off of AC power or the internal rechargeable battery pack. It is recommended to run the Si-CA 8500 off AC power as often as possible for maximum operating time and optimal chiller performance.

Power is supplied by a rechargeable battery pack. A 100-240 Volt AC charger having a 12 Volt DC/2.5A output is supplied with the instrument. The battery charger will fully charge the battery pack in a minimum of six hours.

A fully charged battery pack will supply power to the analyzer for approximately 3 to 5 hours of continuous operation depending on the unit's options and utilization.

A new Si-CA 8500 should be charged with the unit powered off for 12 to 24 hours. It is not suggested to charge the unit for more than 24 hours when powered off.

If the battery pack is fully discharged, charge the analyzer while off for at least 1 to 2 hours before turning the analyzer on.

You can check the condition of the batteries at any time:

1. By pressing the **MEASURE** key, (small font screen) and observing the battery icon, located at the bottom of the display, in the middle, or
2. By pressing the **SETUP** key and observing the actual battery voltage, displayed on the last line. When the unit is operating on battery power, the voltage displayed will vary from an initial 8.0 to 8.4 volts (fully charged) dropping slowly to approximately 7.25 volts (batteries nearly empty). When the battery voltage drops to 7.3 volts a "low battery" warning will appear on the display. Within a few minutes later the instrument will automatically turn off, to preserve the remaining battery power for the sensor bias voltages.

## CHAPTER 5 - SAMPLE FLOW & SAMPLE CONDITIONING SYSTEM

---

### PART A. THE EXTRACTION PROBE AND SAMPLING LINE

A number of different types of probes are available depending on the application requirements. The probe consists of the extraction probe, the sampling line and the stack thermocouple.

1. Medium temperature probe and sampling line. This standard probe is suitable for temperatures up to 800°C/1470°F.
2. High temperature probe and sampling line. This probe uses an inconel extraction probe suitable for temperatures up to 1200°C/2200°F and very low NO<sub>2</sub> and SO<sub>2</sub> loss sampling line suitable for emissions measurements. Different extraction probe and sampling line lengths are available on request.

The end of the probe's sampling line connects to the SAMPLE IN quick disconnect connector of the analyzer and the thermocouple connector connects to TEMPERATURE STACK input of the analyzer.

**Pitot tube** – This optional part consists of stainless steel tubing with the tips open and bent at a certain angle according to the EPA specifications of 40CFR60 Appendix A, Method 2 for measuring stack gas velocities. The S-Type Pitot tube must always be oriented with the open tips parallel to the direction of the stack gas flow. Care must be taken to keep the tubes from getting clogged by soot particles. The end of the Pitot tube assembly is connected by means of two flexible hoses to a very accurate pressure transducer located inside the analyzer.



### PART B. THE SAMPLE CONDITIONING SYSTEM

The purpose of the sample conditioning system is to remove the excess condensation from the extracted stack gas sample and also to remove soot particles. The exhaust sample contains typically between 5% and 20% of water vapor, most of which will condense in the probe and sample line.

NO<sub>2</sub> and SO<sub>2</sub> are gases that are highly soluble in water. To prevent significant loss of NO<sub>2</sub> and SO<sub>2</sub> during transport of the sample from the probe to the analyzer, the following conditions must be satisfied:

1. Rapid sample transport. This is accomplished by maintaining a high flow rate using a relatively small diameter sampling line.
2. Preferably use of a sample line made from a highly hydrophobic material, such as Teflon, Viton, or stainless steel.
3. Minimum contact of the gas sample with the water collection mechanism and also no additional condensation to occur following the thermoelectric chiller. This is accomplished by using a specially designed Peltier cooled manifold to separate the gas from the water.

Additionally, an optional SCU (Sample Conditioning Unit) shown in the photo below can be used to dry the stack gas before it passes through the sample hose. The SCU is recommended for applications of high moisture applications and/or when measuring Low NO<sub>x</sub> or Low SO<sub>2</sub>.

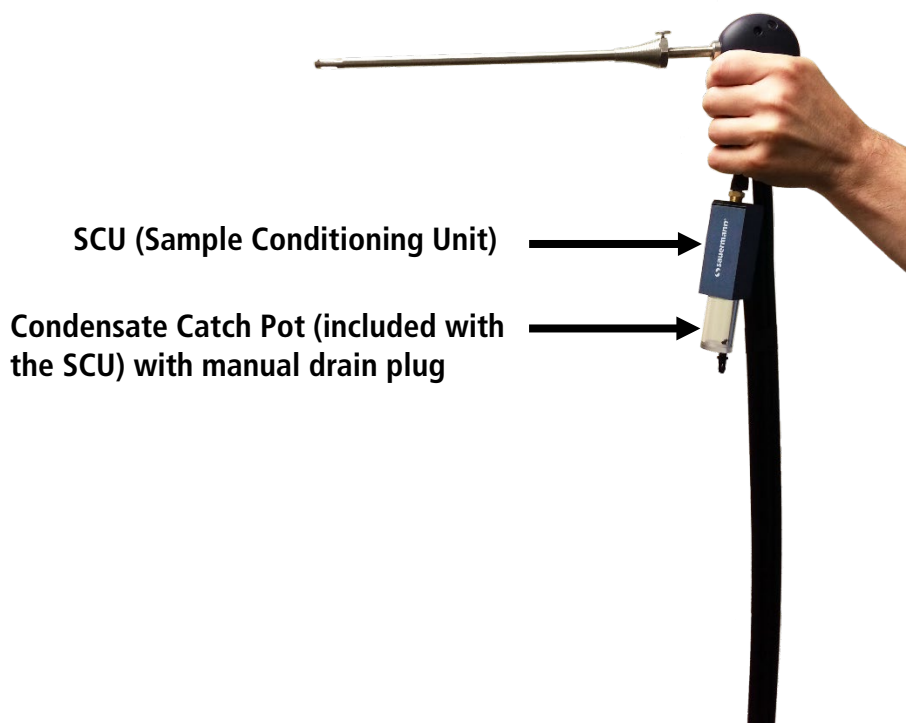

Sauermann has designed a Sample Conditioning Unit (SCU) mounted right at the sampling probe exit before the sampling hose, where the water can rapidly condense and separate immediately from the gas therefore minimizing any contact of the target gases with the liquid water. Additionally, the Si-CA 8500 has an internal thermo-electric chiller to eliminate any water mist remaining in the gas as a protection for the sensors used in the analyzers.

This SCU method allows operators interested to measure low ranges of NO<sub>2</sub> and SO<sub>2</sub>, even down to levels below 10 ppm, to achieve a high level of accuracy in their spot and short-term measurements using one of the Sauermann portable gas analyzers.

When measuring with the analyzer, always keep the SCU in a vertical position as it hangs directly below the probe handle. Keep the SCU from contacting any hot surfaces.

The clear water catch pot at the bottom should be completely drained before 1.25 cm (0.50") of condensate accumulates at the bottom of the water catch pot and also at the end of each use. The catch pot can easily be drained by pulling down on the drain plug as shown in lower left part of the figure above. Be sure to securely and completely push the drain plug back into the catch pot after draining.

Do not pull the drain plug when in the middle of actively measuring with the analyzer as air can leak into the drain hole and affect the measured values.

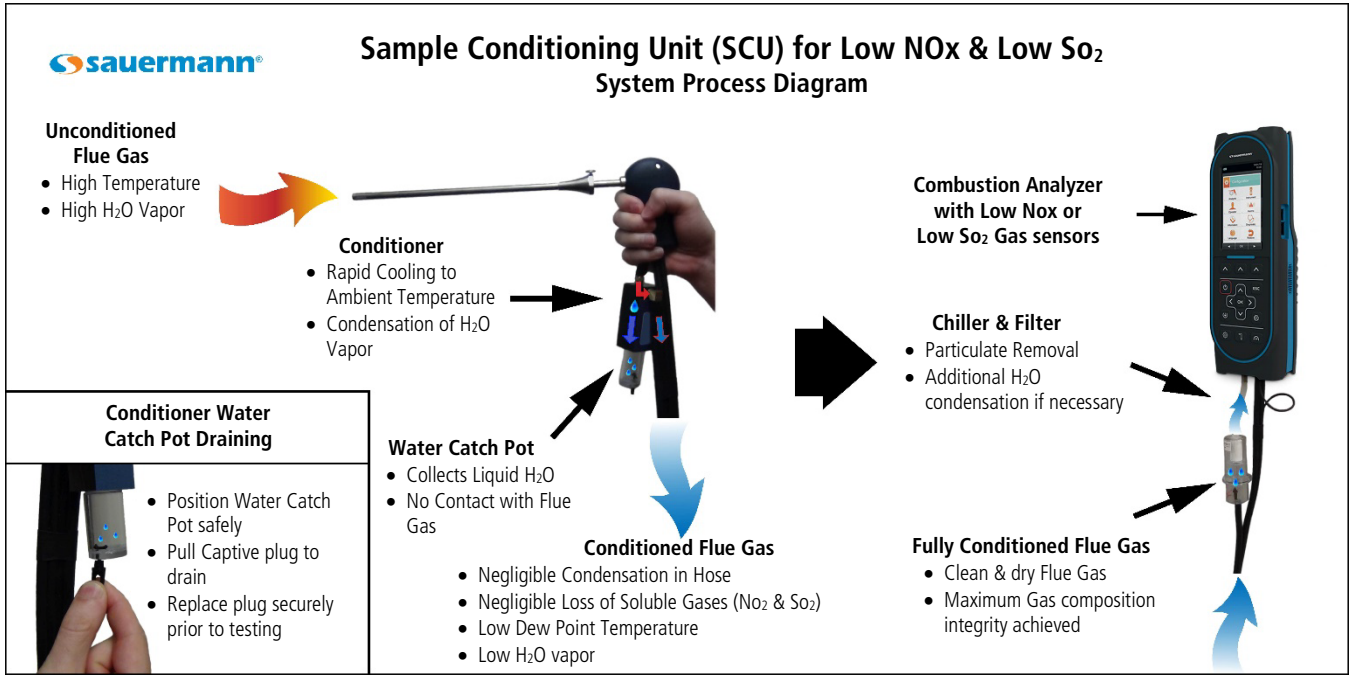

This schema describes the Sample Conditioning Unit working principle on a Si-CA 320 Flue Gas analyzer. The working principle is similar on a Si-CA 8500 emissions analyzer.

The sample conditioning system located inside the analyzer as shown in the following photo:

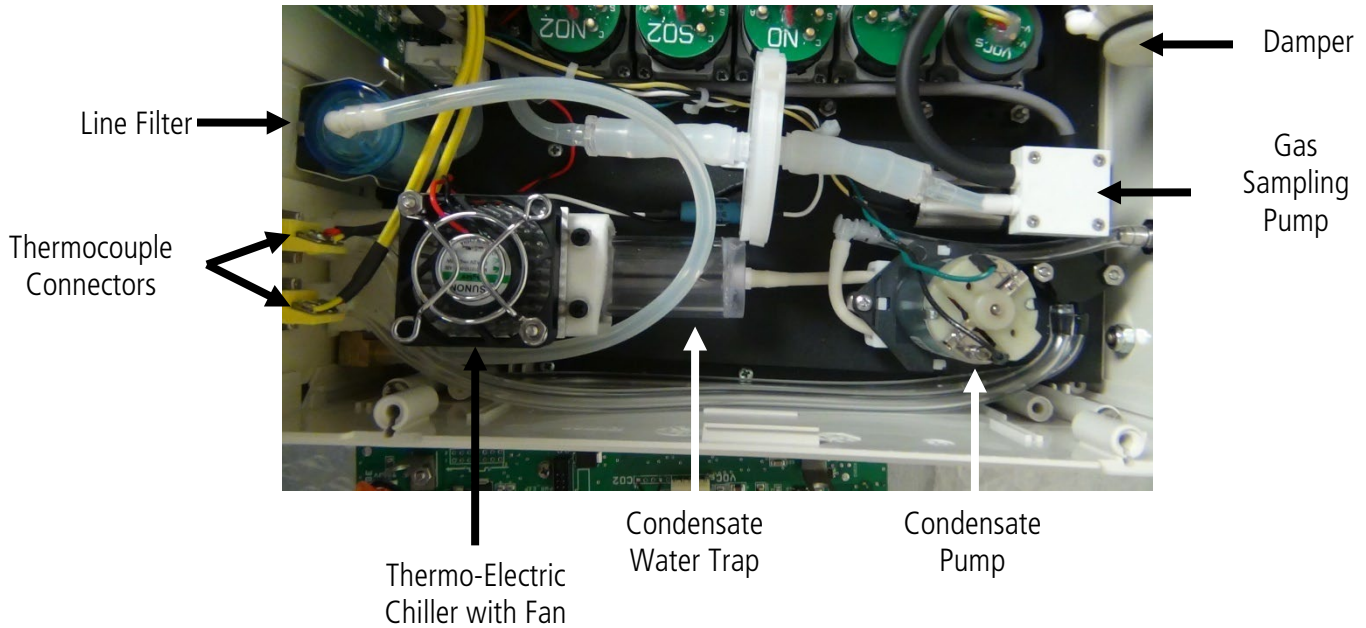



The following components are mounted on the conditioning system:

1. Thermoelectric chiller. The sample gas enters this aluminum manifold from the front panel. The condensed water is removed and collects at the bottom. The dry sample exits towards the filters. The manifold is cooled by the Peltier element, powered by electrical pulses of user-settable duty cycle. By cooling the chiller below ambient temperature, any further condensation in the analyzer is prevented. The chiller will maintain the sample at a certain temperature below ambient temperature to ensure that no further condensation takes place inside the analyzer. You can control this temperature differential by adjusting the CHILLER DUTY CYCLE, if necessary, as detailed below.

The duty cycle of the thermoelectric chiller is set at the factory to 75%. It should not be adjusted unless when being used to measure a stack gas with very high water content. It can be adjusted as follows:

- 1) Press the **SETUP** key. The **SETUP MENU** will be displayed.
  - 2) Press the **UP/DOWN** keys until the cursor points to **COOLER DUTY**.
  - 3) Press the **OK** key.
  - 4) Use the **UP/DOWN** keys to set the power duty cycle.
  - 5) Press the **OK** key.
2. Water trap. The condensed water collects inside this water trap.
  3. Condensate pump. This peristaltic pump operates automatically on a periodic basis that can be set by the customer to remove the condensed water from the water trap and discharge it in the back of the instrument. The default operation is 30 seconds on, 25 minutes off.
  4. Line filter. The dried gas sample goes through a disposable fiber filter whose function is to trap any soot particles from the sample. This filter must be inspected often especially for oil or coal fired applications.
  5. Condensation filter. The primary function of this 2 ¼" (5.08 cm) diameter filter is to prevent any residual condensation from reaching the sensors area. This precaution is particularly important, especially if the analyzer is equipped with an NDIR sensor bench.
  6. Sample pump. This is a high quality diaphragm pump whose function is to extract a sample from the stack. Its flow rate is adjustable and can be set by instrument command (pump duty). Typical flow rates are 1.1 – 1.4 liters per minute.
  7. Damper. The last component in the conditioning system is a small damper whose function is to smooth the flow pulsations generated by the sample pump. The electrochemical sensors are diffusion type and their accuracy is affected by significant flow pulsations.

## CHAPTER 6 - SENSORS

The great versatility of the Model Si-CA 8500 Emissions system is partly due to the large number of sensors available within a single analyzer.

These sensors are primarily gas sensors and can be grouped into three categories based on their principle of operation:

1. Seven electrochemical gas sensors
2. Three NDIR (non-dispersive infrared) gas sensors
3. One PID (photo-ionization) sensor
4. Non-gas sensors (temperature & draft/stack gas velocity) sensors

The figure below shows the location of the sensors on their housing:

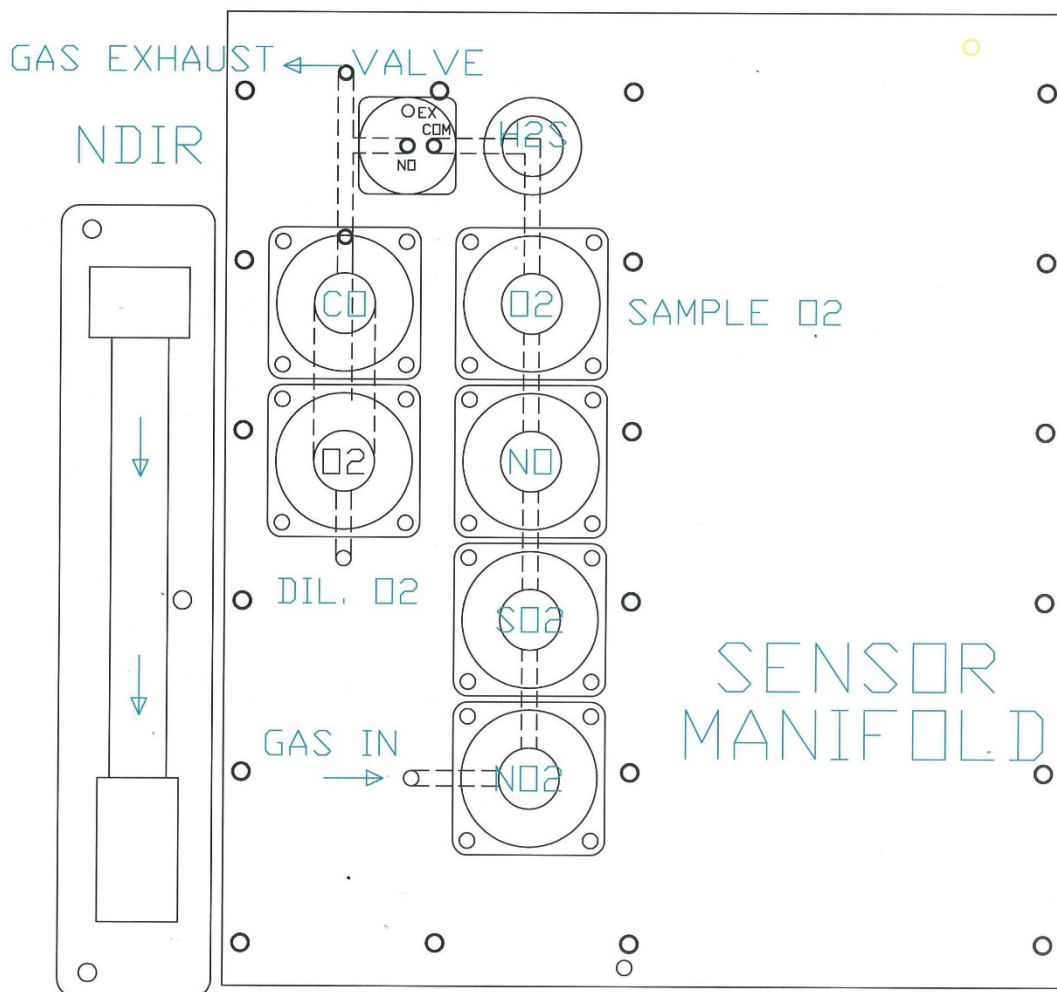

## 1. ELECTROCHEMICAL SENSORS

All electrochemical sensors, except for the H<sub>2</sub>S sensor are of the 5 series type mounted on bayonet style fittings for easy removal.

The electrochemical sensors are described below following the order by which the gas flows through the manifold.

### A. Nitrogen dioxide sensor (NO<sub>2</sub>)

This is a three-electrode sensor that responds to nitrogen dioxide gas. Nitrogen dioxide is a “sticky” gas and this sensor’s response is usually the slowest of all sensors.

B. Sulfur dioxide sensor (SO<sub>2</sub>). It is a three-electrode sensor that responds to sulfur dioxide gas. It is equipped with an inboard filter to remove interference from H<sub>2</sub>S gas.

### C. Nitric oxide sensor (NO sensor)

This is also a three-electrode sensor that responds to nitric oxide. It is equipped with an inboard filter to remove any interference from NO<sub>2</sub> or SO<sub>2</sub> gases.

The nitric oxide sensor requires a constant bias-voltage for proper operation. This is supplied by the analyzer’s battery. If the battery voltage drops below a certain value the analyzer will turn off automatically to maintain the sensor bias. If, however, the battery voltage further drops to near zero, one must wait 24 hours after connecting the battery charger, for the sensor bias to recover.

### D. Oxygen sensor (O<sub>2</sub> sensor)

This sensor measures the oxygen concentration in the sample. It is a two-electrode electrochemical cell. It has a silver cathode and a lead anode. Oxygen diffuses through a tiny hole and reacts with the lead anode. The reaction produces an electric current. The unit software linearizes the current vs. oxygen response. The cell becomes exhausted when all the lead is consumed.

### E. Hydrogen sulfide sensor (H<sub>2</sub>S)

This is a 4-series three-electrode micro sensor with low methanol interference. It measures the concentration of hydrogen sulfide, which is a highly toxic gas. Special precautions must be taken during calibration.

### F. Carbon monoxide sensor and sensor assembly (CO)

Unlike the other toxic sensors the carbon monoxide sensor is mounted in an assembly that includes a three way electronic valve and an additional oxygen (dilution) sensor. The sensor itself has an inboard filter to remove interference from NO gas.

This sensor has four electrodes. One measures the concentration of carbon monoxide gas and the other the concentration of any interfering hydrogen gas (It is hydrogen compensated).

Furthermore, this sensor assembly is designed to provide the CO sensor with a dual range capability and also to purge the sensor with air, if the CO gas concentration exceeds the sensor’s diluted upper limit.

If the CO concentration exceeds the sensor's low range selectable upper limit, a "dilution" pump turns on mixing dilution air with the sample. A second "dilution" oxygen sensor measures the resultant concentration of the combined sample and air streams and computes the correct CO concentration.

(For still higher CO concentrations please refer to the NDIR CO sensor option).

## 2. NDIR (INFRARED) SENSORS

The Si-CA 8500 emissions analyzer can be equipped with non-dispersive infrared sensor (NDIR) measurement capability for the measurement of three gases: carbon monoxide (high range), carbon dioxide and hydrocarbons.

The NDIR bench is designed for operation with combustion flue gas measurements and also engine exhaust gases, according to the California BAR 97 regulations.

The infrared option has the following specifications:

GAS	RANGE	ACCURACY
CARBON MONOXIDE (CO)	0% to 15%	±3% rdg
CARBON DIOXIDE (CO <sub>2</sub> )	0% to 50%	±3% <20% ±5% rdg >20%
HYDROCARBONS (HC or C <sub>x</sub> H <sub>y</sub> )	0 – 3.00 %	±3% rdg +0.01%

## 3. PID (Photo-Ionization) SENSOR

The Si-CA 8500 emissions analyzer can be equipped with a PID (photo-ionization) sensor to measure Volatile Organic Compounds (VOC). The VOC sensor measuring range is 0 to 200 ppm. When the VOC sensor option is chosen, the VOC mounts into the manifold where the H<sub>2</sub>S sensor is usually mounted. The VOC sensor and the H<sub>2</sub>S sensor cannot be concurrently installed into the same Si-CA 8500 analyzer (must choose one or the other, not both). The VOC sensor option can only be chosen when the NDIR sensor option is also chosen.

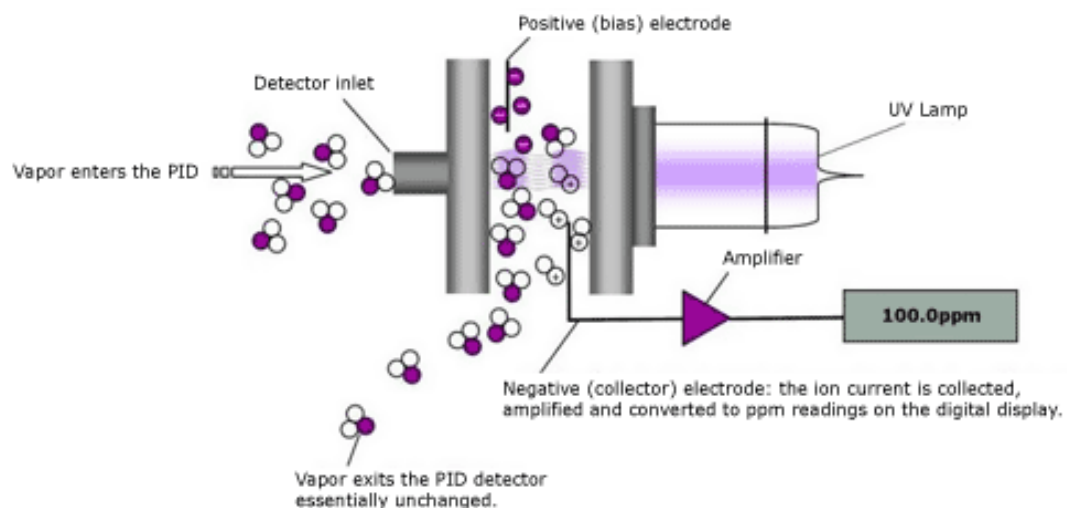

The VOC sensor uses a 10.6 eV PID Lamp for VOC detection. Therefore, the VOC sensor will detect most volatile organic compounds that have an ionization potential of 10.6 eV or lower.

The only other gases measured by the Si-CA 8500 and are typically found in a combustion flue/exhaust gas that have an ionization potential less than 10.6 eV and can affect the measurement of the VOC sensor are NO (9.25 eV) and H<sub>2</sub>S (10.46 eV). NO has a VOC response factor of 7.2, and H<sub>2</sub>S has a VOC response factor of 3.2. So for example, if you measure NO at 72 ppm then you should decrease the VOC measurement by 10 ppm to see the measurement of VOCs other than NO.

#### **4. NON-GAS SENSORS**

A. Ambient temperature sensor

This is an IC sensor located near the cold junction of the thermocouple. The ambient temperature is displayed on the CALIB screen and is used for temperature compensation. This sensor is located in the vicinity of the gas sensors and also monitors the temperature of the cells as required by the EPA's Method CTM-034.

B. Stack temperature sensor

The thermocouple is located at the tip of the probe. It measures the stack temperature minus the ambient temperature. The thermocouple junction is a shielded, ungrounded, inconel sheathed, type K thermocouple with a capability of measuring temperatures from 0 to 2000°F. The instrument software linearizes the thermocouple output to improve the accuracy.

C. Draft sensor / Gas velocity sensor.

If the analyzer comes with the stack gas velocity option (separate S-type pitot tube and tubing), the pressure sensor, located inside the analyzer, is a very low range (0-10" WC) pressure sensor.

If the analyzer does not have the gas velocity option, then the pressure sensor is a 0-1 PSI, higher range sensor for the measurement of stack draft.

Pressure/velocity will zero every time an autozero countdown is carried out.

## CHAPTER 7 - ANALYZER SETUP

---

The SETUP MENU allows the operator to change system parameters.

OCT 1 '15 12:45:00
Fuel: NATURAL GAS
Temperature Units: F
Measure Units: PPM
Pressure Units: inWC
O2 Reference: TRUE
Pumps: AUTO 1500cc/m
Dilution Duty: 90%
Water Drain: 25min
Chiller Duty: 70%
Dilute CO: 5000 PPM
Use CO-IR: 7000 PPM
Thermal Eff: 0.25
Display Contrast: 24
Baudrate: 9.6 kbps
Velocity Units: FPS
Stack Size: 144 in <sup>2</sup>
Version: 1.01
Battery: x.xx V

Every parameter listed on the SYSTEM MENU screen can be changed as follows:

- a. Use the **UP / DOWN** keys to move the highlighted line to the parameter you wish to change.
- b. Press **OK** to edit the value. The arrow will disappear as the current line shifts to the left by one character and a cursor appears over the value. This indicates that you are in edit mode.
- c. Use the **UP / DOWN** keys (buttons displaying the triangles) until the desired value of the selected parameter appears on the display.
- d. Press the **OK** key to execute the change.

A more detailed explanation of each parameter follows:

- 1) DATE & TIME: The analyzer's internal clock is displayed in the format month-day-year, hour-minute-second. Hours are always displayed using a 24-hour clock format.
- 2) FUEL: The analyzer has the following fifteen fuels stored in its memory
  - (1) #2 OIL
  - (2) #4 OIL
  - (3) #6 OIL
  - (4) NATURAL GAS
  - (5) ANTHRACITE (COAL)

- (6) BITUMINOUS (COAL)
- (7) LIGNITE (COAL)
- (8) WOOD, 50% MOISTURE
- (9) WOOD, 0% MOISTURE
- (10) KEROSENE
- (11) PROPANE
- (12) BUTANE
- (13) COKE OVEN GAS
- (14) BLAST FURNACE
- (15) SEWER GAS

To select the desired fuel, press the **UP / DOWN** keys until the desired fuel appears on the top of the display and then press **OK**. The fuel selection affects the following parameters: combustion efficiency, carbon dioxide calculation and display of toxic gases in units other than PPM.

- 3) TEMPERATURE UNITS: The **UP / DOWN** keys toggle between °F (Fahrenheit) and °C (Celsius). Stack temperature and ambient temperature will be displayed, printed, and saved in the selected units.
- 4) MEASURE UNITS: When the cursor is blinking on this line, you can select any of the following units of measurement for the toxic gases (CO, NO, NO<sub>2</sub>, SO<sub>2</sub>, H<sub>2</sub>S & VOC):
  - PPM: Parts per million (volumetric)
  - MGM: Milligrams per cubic meter
  - #/B: Pounds (of pollutant) per million BTU of fuel
  - GBH: Grams (of pollutant) per brake horsepower-hour

To choose the desired emission units, toggle the **UP / DOWN** buttons until the proper units are displayed. Then press the **OK** key. If you select GBH (grams/brake horsepower-hour) as the desired units, you must not forget to set the value of the (engine) thermal efficiency also! You can obtain this figure from the engine's manufacturer specifications. It differs somewhat as a function of engine type and load factor. (Typically, it is a number between 0.25 and 0.35) The analyzer's default value is 0.25. If the thermal efficiency is not known, it may be computed by using the engine's BSFC (brake-specific fuel consumption-BTU/BHP-HR) as follows:

$$\text{ENGINE EFFICIENCY} = 2547/\text{BSFC}$$



NOTE: Emission measurements in PPM, MGM, #/B and GBH are carried out on a dry basis as required by the EPA's 40CFR75. (The Si-CA 8500 is an extractive analyzer, whose conditioning system removes most of the water vapor before the sample reaches the sensors).



NOTE: MGM (milligrams per cubic meter) units are calculated and displayed for 20C and 1 atm conditions per US EPA standards.



NOTE: Values of emissions in #/B and GBH are fuel and CO<sub>2</sub> dependent. The fuel parameters for certain typical fuels used in the analyzer (i.e. the F- factors for anthracite, etc.) have been modified to be identical to those specified in 40CFR60 Appendix A method 19 of the code of federal regulations.



**NOTE: NO and NO<sub>x</sub> emissions in #/B, MGM, and GBH are computed as NO<sub>2</sub> per US EPA Standards**

- 5) PRESSURE UNITS: The Stack Draft measurement can be shown in inches of water (inWC), millibar (mbar), millimeters of water (mmWC), or kilopascal (kPa).  
 $1 \text{ mbar} = 0.10 \text{ kPa} = 0.40 \text{ inWC} = 10.2 \text{ mmWC}$
- 6) CxHy UNITS: The hydrocarbon measurement can be displayed in either % or ppm units. The factory setting is for % units, and % units are recommended for most hydrocarbon measurements. The ppm units are only recommended for very low hydrocarbon measurements.  
 If using ppm units, an extra autozero calibration should be done within the first few minutes after the initial autozero calibration has been completed. Additionally, extra autozero calibrations should be done every 30 to 45 minutes. These extra autozero calibrations will allow for greater accuracy of the CxHy measurements especially when measuring in ppm units.
- 7) O<sub>2</sub> REFERENCE: Many environmental regulations require that the concentrations of pollutants measured, be corrected to some reference value of oxygen other than the actual concentration at the time of the measurement. Typical oxygen reference values are 0% (air free), 3%, 7% or 15%. To select the desired oxygen reference value, press the **OK** key repeatedly until the blinking cursor is located on the OXY REFERENCE line on the display, as described above. Toggle the **UP / DOWN** buttons, until the desired value of the reference oxygen is displayed. (Range is 0-20% in 1% increments). Then press the **OK** key. When the O<sub>2</sub> reference is set at anything other than "TRUE", the O<sub>2</sub> measurement on the display screen will have reverse contrast (white letters/numbers on dark background). To return to uncorrected measurements, press the **UP** button until the display reads:

O<sub>2</sub> REF: TRUE



NOTE: Setting the OXYGEN REFERENCE to a value other than TRUE affects values of emissions concentrations in PPM and MGM. It does not affect values in #/B or GBH.

- 8) PUMP: Pump status is displayed:
- AUTO - Automatic sample and dilution control mode is selected, and typical flow-rate is shown.
  - SAMPLE - Pump remains in sample mode (dilution disabled), and the current duty cycle of the pump is shown. The duty cycle can be set\* with the **UP / DOWN & OK** keys.
  - DILUTE - Pump remains in dilution mode, and the current duty cycle of the pump is shown.



**\*Note: The manufacturer strongly suggests not changing the duty cycle values without consulting the manufacturer first.**

- PURGE – Purge mode is enabled, and the sample pump is turned off.
  - OFF – All pumps are turned off.
- 9) DILUTION DUTY: This controls the power to the dilution pump. The manufacturer strongly suggests not changing this duty value without consulting the manufacturer first.
- 10) WATER DRAIN: This controls how often the analyzer's peristaltic pump should drain water from the small water trap of the conditioning system
- 11) CHILLER DUTY: This setting adjusts the temperature of the thermoelectric chiller. See CHAPTER 5.



- 12) DILUTE CO: This sets the CO concentration above which the dilution system will be engaged. The default value is 5000 PPM.
- 13) PURGE CO / USE CO-IR: This sets the maximum CO concentration for the electrochemical sensor. Higher concentrations will engage a purge cycle for the CO sensor to prevent it from becoming saturated. Factory default is set at 7000 PPM. If you have an NDIR infrared system, the infrared CO data will be used above this point. With the infrared system, CO is always displayed as a percentage (%).
- 14) THERMAL EFF: Selects the thermal efficiency of the engine. See MEASURE UNITS above.
- 15) DISPLAY CONTRAST: Select the best value for viewing the LCD screen.
- 16) BAUDRATE: The speed of the Bluetooth® port is set here.
- 17) VELOCITY UNITS: (Velocity Option) Select between feet per second (FPS), meters per second (MPS), cubic feet per minute (CFM), or cubic meter per minute (CMM).

**VELOCITY AND DRAFT/PRESSURE CAN NOT BE MEASURED SIMULTANEOUSLY.  
USER MUST CHOOSE ONE OR THE OTHER.**

To change the selection, hit the **SETUP** key. Using the **DOWN** arrow key, scroll Down to **Velocity Sensor** and hit **OK**. The **OFF/ON** selection will be highlighted. Use the Up & Down arrow keys to change the selection from OFF to ON or vice versa. With the Velocity Sensor selection **OFF**, the analyzer will measure **Draft/Pressure (DFT)** automatically. With the Velocity Sensor selection **ON**, the analyzer will measure **Velocity (VEL)** automatically. When you have your selection chosen, hit the **OK** button and the entire Velocity Probe will be highlighted again. Hit the **MEASURE** Button to get back to the main measurement screen once you are complete.

Connect the supplied hoses from the S-Type Pitot tube to the positive (+) and negative (-) PRESSURE connections on the top/front of the analyzer. The S-Type Pitot tube must always be oriented with the open tips parallel to the direction of the stack gas flow as shown on the following figure:

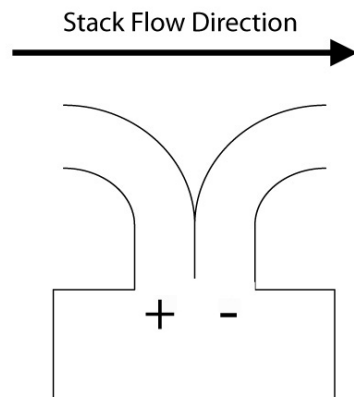

- 18) STACK SIZE: (Velocity Option). Estimate the cross-section area of your stack in square inches (in<sup>2</sup>) and set this value to obtain accurate stack gas flow measurements in CFM or CMM.

## CHAPTER 8 - INTERNAL DATA STORAGE

---

The STORE MENU allows the operator to store data and manage the internal storage tags.

Store Current Buffer
Select Buffer
Start Average Test
Start Periodic Store
Store Interval: 1m
Test Length: 30 min
Review Buffer
Name Buffers
Erase Buffers

The Si-CA 8500 has 2000 internal storage tags. Each tag stores one complete set of emissions data. There are two ways to store emissions data to the analyzer's buffer. You can either store data by selecting the option STORE CURRENT DATA after pressing the **STORE** key, or alternatively you can make use of the analyzer's capability of storing data automatically on a periodic basis. You can set the time period between data storage. The STORAGE MENU shows the relevant display lines for the storage options.

1. STORE CURRENT BUFFER: The analyzer will store one set of data into the tag currently selected. The index number and the name of this tag appear at the bottom of the screen.
2. SELECT BUFFER: Selecting this item will display an index of the analyzer's 2000 internal storage tags. Tags that are used have an icon next to their index number. The selected storage tag is indicated by the reverse color line. When data is stored, this pointer will automatically advance to the next available tag. If you want to store data in a different location, use the UP, DOWN, & OK keys to select a new tag. As you scroll up and down, tags containing data show their date and time at the bottom of the display. Empty tags show the word empty.
3. START AVERAGE TEST: This will begin a period of data averaging, with the average values stored periodically in successive memory tags. The interval between each storage cycle is displayed below and can be set by the user. Once enabled, this line will read: STOP AVERAGE TEST.
4. START PERIODIC STORE: This will turn on the periodic store function. In this mode, the unit will continuously store data at an interval displayed on the next line. Once enabled, this line will read: STOP PERIODIC.

At the end of the test interval, the screen will automatically switch to the Name Buffers screen, prompting the user to enter a unique name for the sequence. This step can be skipped by pressing the Measure button.

5. STORE INTERVAL: The time between each store is set here. This can range from 10 seconds to 60 minutes.
6. TEST LENGTH: The total time period of the periodic data storage test. This can range from 1 minute to 120 minutes or set to OFF.

7. REVIEW BUFFER: This choice allows you to view previously saved data. Press **OK**. The display will switch to the data screen, with the data in the first tag displayed. The time and date when the data was saved will appear at the bottom of the display. Use the **UP / DOWN** keys to scroll through the tags.

8. NAME BUFFERS: This choice will take you to another screen where you can rename one or more tags. This is useful if you use several tags together to form a test series. Select the starting test index with the **UP / DOWN / LEFT / RIGHT** keys and press **OK**. Next, select the ending test index. The cursor will move to the first character of the first tag's name, and the alphanumeric keyboard will appear. Use the **UP / DOWN / LEFT / RIGHT** keys to navigate around the keyboard and press **OK** to select the letter or number. For lower-case letters, highlight shift and press **OK**, for symbols, highlight sym and press **OK**. The arrows in the corner will move the cursor forward or backward through the tag's name.

*** NAME BUFFERS ***										
Starting Tag: 00										
Ending Tag: 00										
Name :xxxxxxxxxxxxxxxxxxx										
1	2	3	4	5	6	7	8	9	0	◀
A	B	C	D	E	F	G	H	sym	▶	
I	J	K	L	M	N	O	P	shift		
Q	R	S	T	U	V	W	X	Y	Z	

9. ERASE BUFFER: This option is used to erase stored data. Data that has been stored in the analyzer's memory will be retained even after the instrument has been shut off and its batteries removed. To erase the contents of a specific tag, use the **UP / DOWN** keys to move the arrow to the desired tag. As you scroll up and down, tags containing data show their date and time at the bottom of the display. Empty tags show the word empty. If you wish to erase all 2000 of the analyzer's stored data, move the arrow to the entry ALL TAGS and press **OK**.

## CHAPTER 9 - WIRELESS REMOTE PRINTER

The Si-CA 8500 uses a wireless remote printer. The printer is powered by a rechargeable battery. The battery can be charged with the same charger that is used for the Si-CA 8500 analyzer. The printer is optional with the Si-CA 8500.

First you must turn the printer on. Then press **PRINT** to scan and connect with your wireless printer to establish communications between the analyzer and the printer.

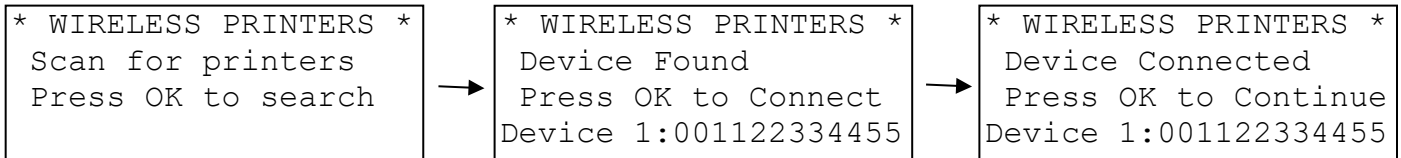

When you have connected successfully the printer's green status light will turn on. Pressing the **PRINT** key will now display the PRINT MENU.

The PRINT MENU allows the user to print test records.

```
Print Test Record
Start Test Log
  Log Interval:
Print Buffer
Edit Customer Name
Calibration Record
Paper Feed On/Off
Mobile Printer...
```

**PRINT TEST RECORD:** This option will print a test record of the current stack parameters.

**PRINT TEST LOG:** This option begins a log of the following combustion parameters: stack temperature, oxygen, carbon monoxide, excess air, and efficiency.

**LOG INTERVAL:** This selects the interval between each log entry. The interval can be set between 1 and 60 seconds.

**PRINT BUFFER:** This option is used to print data stored in the analyzer's memory. Each line corresponds to one storage tag. Tags containing data show an icon next to the index number. When you scroll up and down, the date (mm/dd) and time (hh/mm) when the data was stored appear at the bottom; empty tags show the word "empty". To print the contents of a specific tag, use the **UP / DOWN** keys to move the arrow to the desired tag and press **OK**. If you wish to print all of the analyzer's stored data in sequence, move the arrow to the entry **ALL TAGS** and press **OK**.

```
Serial #: 000000
Company Name
TEST RECORD
OCT 1 '15 12:45:00
Efficiency: XX.X %
T ambient: XXX °F
T stack: XXXX °F
Oxygen: XX.X %
CO: XXXX PPM
CO2: XX.X %
CxHy: XX.XX %
StackDraft: XX.X "wc
Excess Air: XXX %
NO: XXXX PPM
NO2: XXXX PPM
NOx: XXXX PPM
SO2: XXXX PPM
H2S: XXXX PPM
Fuel: NATURAL GAS
O2 Reference: TRUE
```

CONFIGURE RECORD: This option allows the user to add, delete, or change the order of the parameters that appear on the paper print out.

EDIT CUSTOMER NAME: This will display a screen where you can change the information printed at the top of each printout. Usually the customer's name or the operator's name appears here. To edit this information, use the **UP / DOWN / LEFT / RIGHT** keys to navigate around the keyboard, and press **OK** to select the letter or number. For lower-case letters, highlight `shift` and press **OK**, for symbols, highlight `sym` and press **OK**. The arrows in the corner will move the cursor forward or backward through the name.

** EDIT HEADER INFO *									
SAUERMAN ANALYZER									
1	2	3	4	5	6	7	8	9	0 ◀
A	B	C	D	E	F	G	H	sym ▶	
I	J	K	L	M	N	O	P	shift	
Q	R	S	T	U	V	W	X	Y	Z

CALIBRATION RECORD: This option will print a record of each sensor's last calibration, including the date of calibration and span gas value used.

PAPER FEED: This toggles the printer's motor on and off, advancing the paper out the top of the analyzer as needed. The motor will not turn on if there is no paper present.

## CHAPTER 10 - CALIBRATION

Every instrument must occasionally be calibrated against some known value of a parameter in order to make sure that its accuracy has not deteriorated.

Instrument calibration requires two steps. The first step is to zero the analyzer in a clean, ambient temperature environment. The second step uses certified span gas cylinders of known concentration to carry out a span calibration of the gas sensors.

The CALIBRATION MENU lets you set span calibration values for each sensor and performs all sensor calibrations. The CALIBRATION MENU is shown below.

A brief explanation of the parameters shown follows below:

```
**** CALIBRATION ****
Zero All Sensors
Zero Thermocouples
AutoZero Errors
Sensor History
T ambient:    74 °F
T preheat:   74 °F
Zero Time:   60sec
Span Time:  120sec
** Span Lockout **
Span CO:    xxxx PPM
Span H2:    xxxx PPM
Span NO:    xxxx PPM
Span NO2:   xxxx PPM
Span SO2:   xxxx PPM
Span H2S:   xxxx PPM
Span CO-IR:xx.x %
Span CO2:   xx.x %
Span HC:    xx.xx %
Span Draft: xx "
```

**ZERO ALL SENSORS:** This will set the zero point of CO, CO<sub>2</sub>, HC, NO, NO<sub>2</sub>, SO<sub>2</sub>, H<sub>2</sub>S, VOC, and draft or velocity values.

**ZERO THERMOCOUPLES:** This zero the stack and auxiliary thermocouples. The thermocouples must be at room temperature when zeroing.

**AUTOZERO ERRORS:** This will display a list of sensors that were out of the analyzer's acceptable range during the last autozero countdown.

**SENSOR HISTORY:** The date that each sensor was installed is displayed, along with the date the sensor was last calibrated and the span gas concentration used.

**T AMBIENT:** Press the **OK** key to adjust the ambient temperature reading. The display will show:

Amb Temp Offset: 0C

Use the **UP/DOWN** keys to set the value, in °C, to add or subtract to the displayed ambient temperature.

**T PREHEAT:** This is the reading obtained from the second temperature input. It is optionally used to measure the temperature of the preheat air, if preheat air is used.

**ZERO TIME:** This is the countdown time for the autozero procedure. The autozero cycle time should set at 180 seconds.

**SPAN TIME:** When carrying out a span calibration, you must introduce the span gas for an appropriate amount of time before the analyzer executes the span calibration. This setting, which is the same for all sensors, controls this time interval. The span time is indicated in seconds.

**SPAN LOCKOUT:** This controls access to the remaining span calibration menu options. Span lockout prevents accidental or mistaken calibrations. Span lockout is enabled and disabled by entering the 4-digit code of 1315.

SPAN XXXX: The remaining lines of the CALIBRATION MENU are used for carrying out span calibrations of the CO, NO, NO<sub>2</sub>, SO<sub>2</sub>, H<sub>2</sub>S, VOC, NDIR and Stack Draft sensors. For detailed use of these settings, please refer below.

## **A. AUTOZEROING THE INSTRUMENT**

When you turn the instrument on, wait two minutes to allow the analyzer to warm up before carrying out the autozero countdown.

To start the autozero procedure, press the **CALIB** button and select ZERO ALL SENSORS. Make sure that the analyzer pump is pulling in air.

At the end of the autozero period the Si-CA 8500 reads the output of all gas sensors and sets them all to zero, with the exception of the oxygen that it sets to 20.9%. Consequently, it is very important that at the moment of "zeroing", the environment is clean from traces of carbon monoxide or other gases.

If no error messages appear at the end of the countdown, proceed with your measurements.

## **B. RECOMMENDATIONS**

The calibration can be performed by operators or owners of the analyzer if they have the necessary and proper calibration gas bottles and equipment as detailed later in the chapter. The recommended choice for calibration of the analyzer is to send it back to Sauer mann for service that includes complete calibration of all measured parameters, new calibration/adjustment certificate from the manufacturer, and maintenance check-up of the analyzer & relevant accessories. Even if the operators or owners of the analyzer are performing periodic calibrations themselves, it is still strongly recommended to send the analyzer back to Sauer mann annually for factory calibration & service as needed.

## **C. SPAN CALIBRATION**

**TO SPAN CALIBRATE THE ANALYZER, IT IS BEST TO USE ONLY SINGLE GAS MIXTURES WITH EITHER NITROGEN OR AIR BALANCE.**

You must always span calibrate the instrument every time you replace a sensor. At a minimum, you should perform a span calibration of the instrument once every 12 months. For greater accuracy you should check the calibration of the instrument before and after each emissions test. The parameters that require a span calibration are: carbon monoxide, carbon dioxide, nitric oxide, nitrogen dioxide, sulfur dioxide, hydrogen sulfide, volatile organic compounds, hydrocarbons, and draft. You can carry out all span calibrations in sequence or just one, if you wish.

### **Span calibration using your own gas**

If you wish to use your own span gas to perform span calibrations you must take certain precautions in order to calibrate the sensors properly.

Notice that you will need a number of certified gas cylinders. Make sure that you use a bypass flow meter as shown, in order to supply an adequate flow of span gas without developing excessive or insufficient pressure on

the sensors. The accessory ensures proper gas flow to the Si-CA 8500. For greatest accuracy it is recommended that you use a span gas value close to the emission concentration you expect to measure.

Use a piece of tubing to connect one end of a T-junction of the calibration accessory to the Si-CA 8500 probe. Connect the other end of the T-junction with a piece of flexible tubing to the gas cylinder outlet, past the gas regulator and shutoff valve.

You must not feed gas to the Si-CA 8500 under pressure and you must not starve the Si-CA 8500 pump for gas. When feeding the gas, you must maintain a reasonably constant pressure, near ambient pressure. This is a requirement of all diffusion-type electrochemical sensors.

Make sure the concentration of the calibration gas is within the range of each sensor. Do not use gas that will over-range the sensor.

The CO span gas can be in the range of 30 - 2000 PPM, 2% accuracy with balance nitrogen, preferably.  
The NO span gas can be in the range of 10 - 2000 PPM, 2% accuracy with balance nitrogen, required.  
The NO<sub>2</sub> span gas can be in the range of 10 - 500 PPM, 2% accuracy with balance nitrogen or air.  
The SO<sub>2</sub> span gas can be in the range of 10 - 2000 PPM, 2% accuracy, with balance nitrogen, preferably.  
The H<sub>2</sub>S span gas can be in the range of 10 - 200 PPM, 2% accuracy, with balance nitrogen, preferably.  
It is recommended to use Isobutylene to calibrate the VOC sensor, and this span gas should be in the range of 5 - 20 PPM, 2% accuracy, with balance air, preferably.

For the NDIR option, the following ranges are allowed:

- The CO span gas can be in the range of 1.2 – 15.0% with balance nitrogen, preferably.
- The CO<sub>2</sub> span gas can be in the range of 9.0 – 20.0% with balance air, preferably.
- The hydrocarbons span gas can be in the range of 1000 - 30000 PPM with balance nitrogen or air. Hydrocarbon gases such as methane, propane, and hexane can be used for calibration. Methane is used for factory calibrations.

## **Gas Sensor Calibration Procedure**

The following page illustrates the sequence of key strokes to carry out a span calibration of the analyzer. It is assumed that the instrument has been auto-zeroed and there have been no error messages.

### Electrochemical Gas Sensors

1. Turn the analyzer on and press OK to perform an autozero. Allow the instrument to warm up for 15 minutes and repeat the autozero.
2. Connect the outlet from the tee fitting of the gas calibration fixture to the connector on the front of the analyzer labeled "SAMPLE IN" using the set up shown on the following figure:



## Gas Calibration Fixture

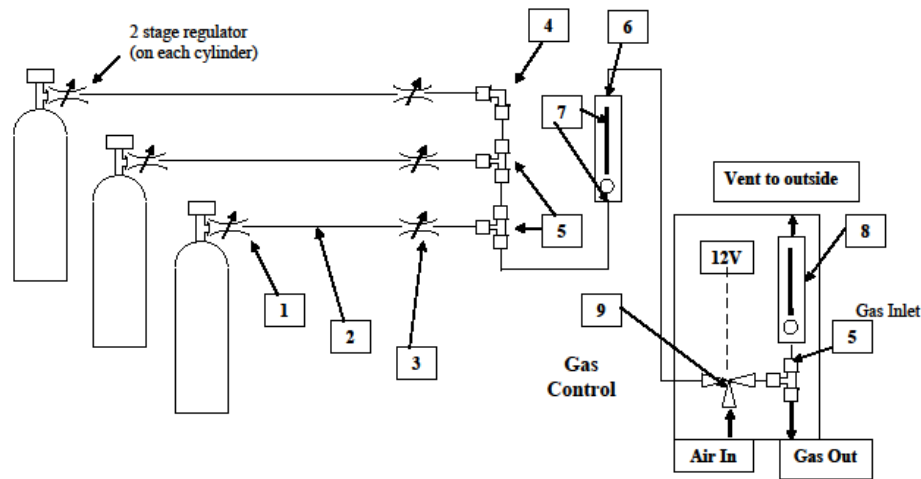

1. Fitting, adaptor, 1/4" MPT x 1/4" O.D. tube, 316 SS
2. Tubing, Parker Parflex, 1/4" O.D. x .040 wall.
3. Ball Valve, 1/4" O.D., 316 SS.
4. Elbow, 1/4" O.D., 316 SS.
5. Tee, 1/4" O.D., 316 SS.
6. Flow meter, 1-10 lpm, Dwyer #127420SV (set @ 4 lpm)
7. Fitting, Adaptor, 1/8" mpt x 1/4" O.D. tube
8. Flow meter 0-1 lpm
9. Solenoid, 3 way

3. Press the button labeled "CALIB" to enter the calibration menu.
4. Scroll down to the SPAN TIME and set the value to 300 seconds.
5. Scroll down to the sensor to be calibrated. If the calibration lock is on, enter the password 1315.
6. Use the arrow keys to enter the span value printed on the calibration cylinder. Press OK.
7. Turn on the gas flow and observe gas readings. If the gas reading for the sensor being calibrated does not increase after a few seconds, turn off the gas flow until the problem is found. Otherwise, press OK.
8. Continue to monitor the readings of all of the gas sensors including oxygen. If the calibration gas being used has a balance of nitrogen, observe that the oxygen reading reaches a minimum of 0.1% (0.4% for nitrogen dioxide). If not, troubleshoot the system for leaks, or replace the oxygen sensor. Monitor the other gas sensors for cross sensitivity.
9. When the countdown reaches 3 seconds, there will be a series of beeps. Verify that the reading for the sensor being calibrated matches the value entered in the calibration menu, and that the reading for all of the other sensors is zero. Turn off the gas flow.
10. Repeat this procedure for each electrochemical sensor to be calibrated.
11. After all of the sensors are calibrated, turn the unit off and back on again, and perform an autozero.
12. Check the accuracy of each sensor by applying the gas and observing the readings.

### NDIR Gas Sensors

1. Turn the analyzer on and press OK to perform an autozero. Allow the instrument to warm up for 15 minutes, and repeat the autozero.
2. Connect the outlet from the tee fitting of the gas calibration fixture to the connector on the front of the analyzer labeled "SAMPLE IN" using the set up shown on the previous page.
3. Press the button labeled "CALIB" to enter the calibration menu.
4. Scroll down to the SPAN TIME and set the value to 20 seconds.
5. Scroll down to the sensor to be calibrated. If the calibration lock is on, enter the password 1315.

6. Use the arrow keys to enter the span value printed on the calibration cylinder. Press OK.
7. Turn on the gas flow and observe gas readings. If the gas reading for the sensor being calibrated does not increase after a few seconds, turn off the gas flow until the problem is found. Otherwise, press OK.
8. When the countdown reaches 3 seconds, there will be a series of beeps. Verify that the reading for the sensor being calibrated matches the value entered in the calibration menu, and that the reading for all of the other sensors is zero. Turn off the gas flow.
9. Repeat this procedure for each NDIR gas to be calibrated.
10. After all of the sensors are calibrated, turn the unit off and back on again, and perform an autozero.
11. Check the accuracy of each sensor by applying the gas and observing the readings.

**IMPORTANT: For the NDIR channels, the span calibration must be carried out within 3 minutes of auto-zeroing the analyzer.**

### **Stack Draft & Pressure Calibration Procedure**

1. Connect a pressure calibration standard to the pressure (+) connector on the front of the instrument.
2. In the SETUP menu, make sure the velocity sensor is off.
3. Press the "CALIB" button to enter the calibration menu.
4. Scroll down to SPAN DRAFT and press OK.
5. Using the calibration standard, generate a pressure value near the maximum stated value for the scale being used, for instance 80 mbar if using the mbar range.
6. Enter the value generated as the span value using the arrow keys and press the enter button.
7. Verify that the reading on the instrument matches the reading on the calibration standard.

## CHAPTER 11 - COMMUNICATIONS

---

The Si-CA 8500 analyzer communicates wirelessly with a computer using its internal Bluetooth® module. The communication protocol is as follows:

BAUD RATE: 115000 baud

FORMAT: 8 bits, 1 stop bit, no parity

HANDSHAKE: None

### **EGAS SOFTWARE**

You can enhance the performance and versatility of the Si-CA 8500 by using the Emissions Gas Analyzer Software (EGAS) program. EGAS is compatible with Windows Operating System.

The EGAS software is a robust package, and allows you to:

1. Monitor all emissions parameters simultaneously.
2. Record maximum, minimum, average and standard deviation for all emissions parameters.
3. Set alarms for every emissions parameter including recording the time duration that alarms have been exceeded.
4. Plot bar graphs and time plots of all parameters.
5. Select a variety of saving and printing options.
6. Enter custom fuel information.
7. Retrieve and save stored data.

Consult the EGAS manual for details on the software. The manual can be accessed by clicking on "Help" and then "How Do I..." in the EGAS software program.

## CHAPTER 12 - MAINTENANCE

The Si-CA 8500 emissions analyzer is a sophisticated analytical instrument designed to perform accurate emissions measurements. However, because the analyzer is a portable, field use instrument that can be used in many environments, care must be taken to prevent physical and environmental abuse to help maintain trouble-free operation.

There are four components that will require periodic inspection or replacement. These are:

1. The disposable fiber line filter for particulates
2. The disposable condensation disk filter for residual moisture
3. Gas sensor periodic replacement
4. Printer paper replacement

### A. Fiber Line Filter and Condensation Disk Filter replacement

The disposable fiber line filter is located inside the analyzer just behind an easily removable panel on the top face of the analyzer next to the keypad. Its function is to prevent soot, smoke & dust particles from reaching the analyzer pump and sensors. The disk condensation filter is located inside the analyzer downstream of the line filter. Its function is to prevent any residual water from penetrating into the sensor area.

The filters should be replaced when they become significantly discolored and/or show any signs of cracks.

**Never operate the analyzer without the filters properly in place.**

Frequency of filter replacement depends on the type of fuel burned in the combustion process being measured and the hours of active operations.

Turn the analyzer **OFF** before replacing any of the filters.

To replace the line filter, turn the four black captive screws and pull out the panel to access the filter **as shown in the photo on the next page**. Disconnect the two pieces of flexible tubing that holds the line filter in place and reconnect the hoses to the new filter. Push the new line filter into the metal holder on the inside part of the removable panel. Then push the removable panel back into place and reconnect the four black captive screws.

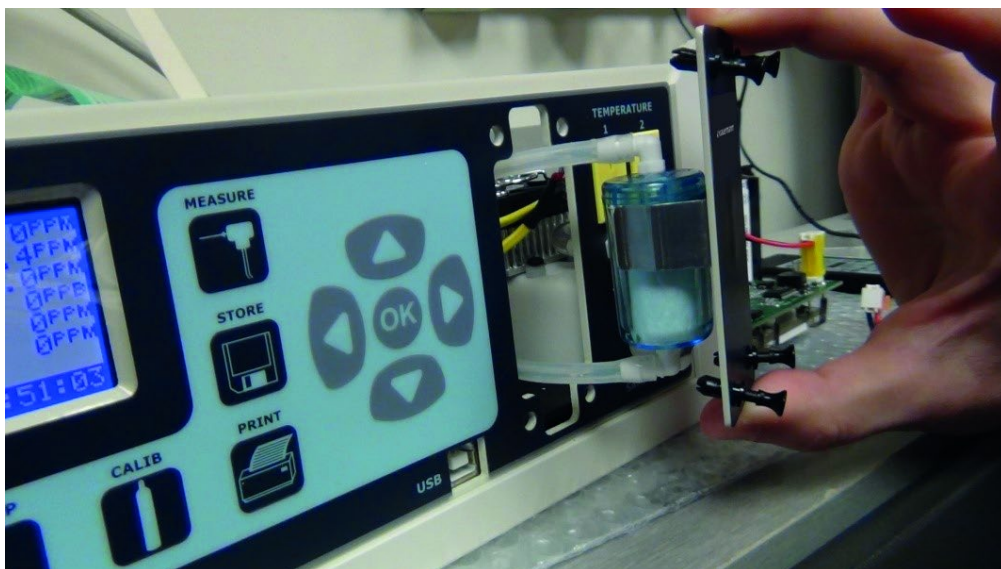

To access the condensation disk filter you must remove the top section of the instrument case. The top section of the analyzer case is held to the bottom section by a total of four retaining screws. With both hands, slide off the vent covers on each side. Use a Philips screwdriver to remove both pairs of retaining screws (one pair on each side of the case). It is best to remove the bottom pair of screws first. Carefully lift the top of the instrument case together with the attached aluminum mounting shielding plate especially since the top & bottom cases pieces are connected with cables/wires. When the plastic case is open, be careful when near the main board because some of the resistors on the board can get significantly hot.

Disconnect the two pieces of flexible tubing that holds the condensation filter in place and reconnect the hoses to the new filter. Secure the new filter to the coated aluminum plate with a tie wrap.

When replacing the condensation disk filter, make sure that the filter's lettering is facing the front/top of the analyzer.

One of the Si-CA 8500 options is a sintered pre-filter that threads into the of the 1 m (40") and 1.5 m (60") probes. If the sintered filter option is included, this item should be periodically inspected and cleaned as needed. If a layer of particulates/dust/ash builds up on this sintered filter, it can be cleaned by removing it from the probe tip and blowing it clean with compressed air and/or soaking it in warm water then rubbing it clean. The sintered filter should be cleaned and dried before threading it back onto the probe tip.

## **B. Condensation removal**

Some water vapor in the stack gas may condense inside the extraction probe and sampling line. However, any remaining excess water vapor in the sample gas will condense inside the thermoelectrically operated chiller, which is located inside the analyzer right behind the Sample In connection. All this water condensation will collect inside the small water trap that is located at the bottom of the chiller assembly. It will then be automatically removed by the peristaltic pump, which operates intermittently to discharge the water through the bottom of the analyzer.

## **C. Sensor replacement**

This should be an infrequent operation, since the gas sensors have a typical life of several years.

If you receive an error message for one of the sensors during instrument operation, do not attempt to replace the sensor immediately. Instead, wait a few minutes and then autozero the analyzer again. If you get an error message again, then investigate and determine if moisture has entered the sensor area. If so, wait a few hours for the moisture to evaporate and then autozero again. If the sensor failure persists then most likely the gas sensor needs to be replaced.

The location of the gas sensors on the manifold is shown in the figure in Chapter 6.

To access the gas sensor compartment on the analyzer, open up the analyzer as detailed on the previous page.

To replace a sensor, locate its correct position on the manifold. Carefully lift the small PC board that is mounted on top of the sensor. Grab the sensor with your fingers and lift it twisting it out of its bayonet fitting.

Take a new sensor. Remove any springs that may be shorting the sensor pins. Install it on its mount and connect the small PC board on top of it.

Replace the top section of the case and secure it with the four screws.

Wait the following time periods before auto-zeroing the analyzer:

O <sub>2</sub> SENSOR	30 minutes
CO SENSOR	30 minutes
NO SENSOR	24 hours
NO <sub>2</sub> SENSOR	30 minutes
SO <sub>2</sub> SENSOR	30 minutes
H <sub>2</sub> S SENSOR	30 minutes
VOC SENSOR	30 minutes

Span calibrate the sensor as explained in Chapter 10. If you are installing a pre-calibrated sensor, use the following procedure:

- 1) While holding the **SETUP** key, press the **MEASURE** key three times. The display will show the sensor factors.
- 2) Press the **DOWN** key until you reach the appropriate sensor then press OK.
- 3) Use the **UP / DOWN** keys to enter the correct factor, digit by digit starting with the hundreds digit, press **OK** to move through the tens, ones, and tenths digits.

# APPENDIX A - Si-CA 8500 - SPECIFICATIONS

---

## ANALYZER

### 1. PHYSICAL

Material: ABS plastic case with internal aluminum shielding  
Dimensions (analyzer): 29.0 x 26.0 x 12.4 cm / 11.42" x 10.24" x 4.88"  
Weight: (analyzer): 5 kg / 11 lbs.  
Carrying case (analyzer & all accessories): Approx. 10 kg / 22 lbs.  
Operating temperature: -5 to +45 °C (23 to 113 °F)  
Storage temperature: -10 to +50 °C (14 to 122°F)  
Environmental conditions of use: from 10 to 90%RH  
Ingress Protection (IP) Rating: IP40

### 2. POWER

7.2 Volt, 8 AH rechargeable battery pack  
Operating time: 3 to 5 hours  
100/240 VAC input, 12 V/2.5A fast charger  
Charging time: 6 hours minimum  
Analyzer Frequency Range: 50-60 Hz  
Power Rating: 25 W

### 3. DISPLAY

6.6 x 3.6 cm (2.6" x 1.4") 128 x 64 chip on glass (white backlit) LCD display.  
Small and large fonts, plus inverted background color for help messages  
Battery condition & charger operation indicator

### 4. WIRELESS REMOTE PRINTER

High resolution, high speed, graphic thermal printer, with charger, prints:

- A. current set of data
- B. stored data
- C. periodic data printouts
- D. calibration history and external messages

### 5. INSTRUMENT PUMPS

- A. Gas sample pump: high quality diaphragm pump with long life motor
- B. CO dilution pump
- C. Automatic condensate drain pump

### 6. STORAGE

2000 internal memory storage tags, each tag stores one complete set of data

### 7. EUROPEAN DIRECTIVES

2014/30/EU; 2014/35/EU; 2014/53/EU (RED); 2011/65/EU (RoHSII); 2012/19/EU (WEEE)

### 8. COMMUNICATIONS

Bluetooth® wireless: Class 1 (100 m)  
USB Cable (2.0)

### 9. SOFTWARE

EGAS Windows software

## SENSORS

### 1. EMISSIONS SENSORS – ELECTROCHEMICAL

SENSOR		RANGE	RESOLUTION	ACCURACY
CARBON MONOXIDE (CO)	Low Range	0 to 8000 ppm	1 ppm	±8 ppm <200 ppm ±4% rdg up to 2000 ppm ±10% rdg for >2000 ppm
CARBON MONOXIDE (CO)	Dilution Auto-Range	0 to 20000 ppm	1 ppm	±10% rdg
NITRIC OXIDE (NO)	Std. Range	0 to 5000 ppm	1 ppm	±5 ppm <100 ppm ±5% rdg for >100 ppm
NITRIC OXIDE (Low NO)	Low Range	0 to 100.0 ppm	0.1 ppm	<50.0ppm, 1.5 ppm To 100.0ppm, 4%
NITROGEN DIOXIDE (NO <sub>2</sub> )	Std. Range	0 to 1000 ppm	1 ppm	±5 ppm <125 ppm ±4% rdg for <5000 ppm
NITROGEN DIOXIDE (Low NO <sub>2</sub> )	Low Range	0 to 100.0 ppm	0.1 ppm	<50.0ppm, 1.5 ppm To 100.0ppm, 4%
SULFUR DIOXIDE (SO <sub>2</sub> )	Std. Range	0 to 5000 ppm	1 ppm	±5 ppm <125 ppm ±4% rdg for <5000 ppm
SULFUR DIOXIDE (Low SO <sub>2</sub> )	Low Range	0 to 100.0 ppm	0.1 ppm	±1.5 ppm <50.0 ppm ±4% rdg for <100.0 ppm
HYDROGEN SULPHIDE (H <sub>2</sub> S)	Std. Range	0 to 500 ppm	1 ppm	±5 ppm <125.0 ppm ±4 % rdg for <500.0 ppm

### 2. EMISSIONS SENSORS – PHOTO-IONIZATION

SENSOR		RANGE	RESOLUTION	ACCURACY
VOLATILE ORGANIC COMPOUNDS (VOC)	Std. Range	0 to 200 ppm	1 ppm	10% rdg. + 1 ppm

### 3. EMISSIONS SENSORS – NON-DISPERSIVE INFRARED (NDIR) SENSORS

SENSOR	RANGE	RESOLUTION	ACCURACY
HYDROCARBONS (HC or C <sub>x</sub> H <sub>y</sub> )	0 to 3.00%	0.01 %	±3% rdg +0.01%
CARBON MONOXIDE (CO)	High Range 0 to 15.00%	0.01%	±3% rdg
CARBON DIOXIDE (CO <sub>2</sub> )	0 to 50.0%	0.1%	±3% <20% ±5% rdg >20%



#### 4. OTHER SENSORS

SENSOR	RANGE	RESOLUTION	ACCURACY
OXYGEN (O <sub>2</sub> ) EC Sensor	0 – 25%	0.1%	0.1% Vol.
Stack Temperature Type K Tc	-20 to +1050°C -4 to 1920°F	1°C 1°F	±3°C ±5°F
Ambient Temperature	-10 to +99.9°C 14.0 to 212.0°F	1°C 1°F	±2°C ±3°F
Stack Draft (piezoresistive)	±100 mbar ±40.0" WC	0.1 mbar 0.1" WC	±1% rdg

#### CALCULATED PARAMETERS

PARAMETER	RANGE	RESOLUTION	ACCURACY
Combustion Efficiency	1 to 99.9%	0.1%	Calculated from fuel, O <sub>2</sub> & dTemp
Efficiency (condensation)	0 to 120%	0.1%	
CARBON DIOXIDE (CO <sub>2</sub> )	0 to 99.9%	0.1%	Calculated from fuel and O <sub>2</sub>
Excess Air	1.00 to infinity	0.01	Calculated from fuel and O <sub>2</sub>
Oxides of Nitrogen (NO <sub>x</sub> )	0 to 5000 ppm	1 ppm	NO + NO <sub>2</sub> Specs.
Emissions 1 (CO, NO, NO <sub>2</sub> , NO <sub>x</sub> , SO <sub>2</sub> , H <sub>2</sub> S)	0 to 2500 mg/m <sup>3</sup>	2 mg/m <sup>3</sup>	Calculated from ppm, O <sub>2</sub> & fuel
Emissions 2 (CO, NO, NO <sub>2</sub> , NO <sub>x</sub> , SO <sub>2</sub> , H <sub>2</sub> S)	0.00 to 99.99 lbs/MBTU	0.01 lbs/MBTU	Calculated from ppm, O <sub>2</sub> & fuel
Emissions 3 (CO, NO, NO <sub>2</sub> , NO <sub>x</sub> , SO <sub>2</sub> , H <sub>2</sub> S)	0.00 to 99.99 g/bhp-hr	0.01 g/bhp-hr	Calculated from ppm, O <sub>2</sub> & fuel
Emissions 4 (CO, NO, NO <sub>2</sub> , NO <sub>x</sub> , SO <sub>2</sub> , H <sub>2</sub> S & CO <sub>2</sub> )	0.00 to 99.99 lbs/hr 0-99.99 tons/day (CO <sub>2</sub> )	0.01 lbs/hr 0.1 tons/day (CO <sub>2</sub> )	Calculated from velocity, ppm, O <sub>2</sub> & fuel
Stack Gas Flow Rate	0 to 65000 cfm	1 cfm	Calculated from velocity, ppm, O <sub>2</sub> & fuel
Stack Gas Velocity	0 to 99.9 m/s 0 to 330 ft/s	0.1 m/s 0.1 ft/s	Meets EPA Method 2

## APPENDIX B - FIRMWARE PROGRAMMING

---

On occasion it may be necessary to update the internal software of the analyzer, also known as the firmware. The firmware can be updated in the field with the use of a computer connected to the Si-CA 8500 analyzer. Firmware updates are available on Sauer mann website, in Resource Center tab. The current firmware version is displayed on the second status screen.

### **Updating the firmware**

1. Locate the programming switches on the right edge of the main PC board of the analyzer. There are 2 miniature slide switches on a black block.
2. Connect communications between the Si-CA 8500 and the computer. Run the firmware update. The program will backup the analyzer's settings.
3. When prompted, toggle the switches on. The firmware will now be reprogrammed. This will take 2 to 3 minutes.
4. When prompted, toggle all the switches off and replace the batteries and cover. The analyzer's settings will be restored.
5. Autozero the analyzer. Check the span calibration of all sensors.

## APPENDIX C - REPLACEMENT PARTS

PART NUMBER	DESCRIPTION
Si-CA8500 Printer	Printer, Wireless Bluetooth® communications, using thermal paper rolls
Si-CA8500 Thermal Paper	Thermal Printer Paper Rolls (pack of 10)
Si-CA8500 Line Filter	Line Filter, disposable, for filtering dust & particulates
Si-CA8500 Cond Filter	Condensation Disk Filter, disposable, for filtering residual moisture
Si-CA8500 O <sub>2</sub> Sensor	O <sub>2</sub> sensor, 0-25 %
Si-CA8500 CO Sensor	CO sensor, 0-8000 ppm
Si-CA8500 NO Sensor	NO sensor, 0-5000 ppm Standard Range
Si-CA8500 NO <sub>2</sub> Sensor	NO <sub>2</sub> sensor, 0-1000 ppm Standard Range
Si-CA8500 SO <sub>2</sub> Sensor	SO <sub>2</sub> sensor, 0-5000 ppm Standard Range
Si-CA8500 Low NO Sensor	NO sensor, 0-100 ppm Low Range with 0.1 ppm resolution
Si-CA8500 Low NO <sub>2</sub> Sensor	NO <sub>2</sub> sensor, 0-100 ppm Low Range with 0.1 ppm resolution
Si-CA8500 Low SO <sub>2</sub> Sensor	SO <sub>2</sub> sensor, 0-100 ppm Low Range with 0.1 ppm resolution
Si-CA8500 H <sub>2</sub> S Sensor	H <sub>2</sub> S sensor, 0-500 ppm (cannot have both H <sub>2</sub> S & VOC sensors in same Si-CA 8500)
Si-CA8500 VOC Sensor	VOC sensor, 0-200 ppm (cannot have both VOC & H <sub>2</sub> S sensors in same Si-CA 8500)
Si-CA8500 NDIR Sensors	NDIR Bench with sensors for CO <sub>2</sub> (0-50%), CxHy/HC (0-3%), & High CO (0-15%)
Si-CA8500 Battery	Rechargeable Battery Pack
Si-CA8500 Charger	AC Charger (Power Supply), 100-240VAC/50-60Hz with 12V Output

## APPENDIX D - CONTACT

Sauermann Industries  
 ZA Bernard Moulinet  
 24700 Montpon  
 France  
 T. +33 (0)5 53 80 85 00



**BE CAREFUL! Material damages can happen, so please apply the precautionary measures indicated.**



Send back the device at its end of working life in a waste collection centre for electrical and electronic components (according to local regulations) or send it back to Sauermann to ensure a required waste collection in the respect of the environment.