



DATA SHEET

Supplied with adjustment CERTIFICATE



CA 310

Large display multifunction transmitter

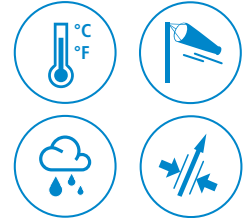

- 1 input for interchangeable probe
- 3 analogue outputs (4 wires) 0/5-10 V or 0/4-20 mA
- 3 audible and visual (dual-color LEDs) alarms
- Alternating display of 1 to 3 parameters

Features

- 1 location for SPI-2 or MVA interchangeable board
- 3 reverse relays 3 A/230 Vac
- 24 Vdc/Vac or 115/230 Vac power supply
- Outputs diagnostic
- Ethernet communication (optional)
- MODBUS network RS485 system (optional)
- ABS V0 swivelling housing
- Large display: 50 x 190 mm

Possible optional measurements

The following probes and boards are available as option for C310 transmitters. For further details please see the technical datasheet of probes for class 310 transmitters.

Probes & boards	Measuring ranges
Stainless steel or polycarbonate hygrometry/temperature probe	From 0 to 100%RH and from -40 to +180°C (according to probe)
Air velocity vane probe: air velocity/temperature/airflow	From -5 to 35 m/s (according to probe) From -20 to +80°C From 0 to 99 999 m³/h
Air velocity hotwire probe: air velocity/temperature/airflow	From 0 to 30 m/s From -20 to +80°C From 0 to 99 999 m³/h
Omnidirectional probe: air velocity/temperature	From 0 to 5 m/s and from 0 to 50°C
Pt100 1/3 DIN temperature probe	From -50 to +180°C/From -20 to +80°C
CO/temperature probe	From 0 to 500 ppm and from 0 to 50°C
CO ₂ /temperature probe	From 0 to 20 000 ppm and from 0 to 50°C
Pressure/atmospheric pressure board	From -100 à +10 000 Pa (according to boards)/From 800 to 1100 hPa
Current/voltage board	3 current/voltage analogue inputs: 0-20 mA/4-20 mA and 0-2.5 V/0-5 V/0-10 V, with terminal block



Part numbers

Part number	Description
CA310-B	Multifunction transmitter, 24 Vac power supply
CA310-H	Multifunction transmitter, 115-230 Vac power supply



Optional probes

General features

Alimentation	24 Vac/Vdc $\pm 10\%$ 100-240 Vac, 50-60 Hz Warning: risk of electric shock 
Output	3 x 0/4-20 mA or 3 x 0-5/10 V (4 wires) Common mode voltage <30 VAC Maximum load: 500 Ohms (0/4-20 mA) Minimum load: 1 K Ohms (0-5/10 V)
Galvanic isolation	On the outputs Device fully protected by DOUBLE ISOLATION or REINFORCED ISOLATION 
Consumption with probe and without option	CA310-B: 11 VA CA310-H: 16 VA (CO ₂ probe additional consumption for 24 V and 115-230 V models: 2 VA)
Relays	3 reverse relays 5 A/230 Vac NO: 5A/NC: 3A/240 Vac
Audible alarm	Buzzer (70 dB at 10 cm)
Electrical connection	Screw terminal block for cables from 0.05 to 2.5 mm ² or from 30 to 14 AWG Carried out according to the code of good practice
RS485 communication (optional)	Digital: Modbus RTU protocol, configurable communication speed from 2400 to 115200 Bauds
Ethernet communication (optional)	Ethernet communication module allowing transmission, monitoring and maintenance of transmitters via an Ethernet network in 10 BASE-T and 100 BASE-TX LAN/WAN supporting TCP/IP protocol (additional consumption for 24 V and 115-230 V models: 1 VA)
Environment & type of fluid	Air and neutral gases
Conditions of use (°C/%RH/m)	From -10 to +50°C. In non-condensing condition. From 0 to 2000 m
Storage temperature	From -10 to +70°C
Security	Protection class 2; Pollution degree 2; Overvoltage category 2
European directives	2014/30/EU EMC; 2014/35/EU Low Voltage; 2011/65/EU RoHS II; 2012/19/EU WEEE

Ethernet board (optional)

An Ethernet board can be put on a CA310 transmitter allowing for each transmitter to have a specific configurable IP address. So the user can remotely interrogate the transmitter, retrieve data, modify the configuration, ...
It is also possible to integrate CA310 transmitters into a computer network via the RJ45 connection located at the bottom of the transmitter.

RS 485 Modbus Protocol (optional)

Class 310 transmitters can be linked in one network operating on a RS485 home bus.
The RS 485 digital communication is a 2-wire network, on which the transmitters are connected in parallel. They are connected to a PLC/BMS via the RTU Modbus communication system. Since the C310 can be configured with the keypad, the MODBUS enables remote configuration, to measure 1 or 2 parameters or to see the status of the alarms...

Features of the housing

Housing	Swivelling (30°)
Material	ABS V0 as per UL94
Protection	IP63
Cable gland	In polyamide for cables Ø8 mm maximum
Fitting	Barbed fittings Ø6.2 mm
Weight	1150 g

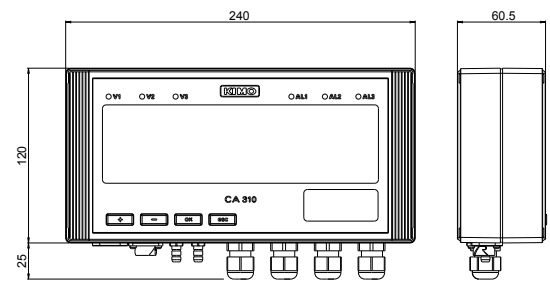

All dimensions are in millimeters.

Relays and alarms

CA310 transmitter has 3 independent and configurable alarms: these are visual and audible alarms and it is possible to couple them with 3 relays.

Available settings:

- Selection of the parameter (pressure, air velocity, temperature,...)
- Time-delays durations from 0 to 600 s
- Alarm action: rising edge, falling edge, monitoring or state of the transmitter
- Operating mode of the relays: negative or positive safety
- Activation of the audible alarm (buzzer), that can be acknowledge by the front keypad

Connections

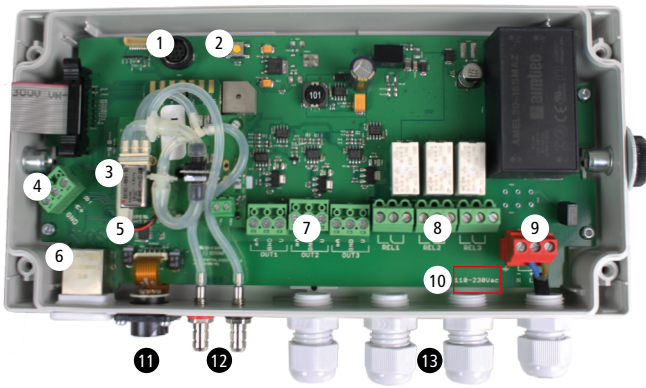

1. LCC-S software connection
2. Autozero
3. Solenoid valve
4. RS 485 connection (d) (optional)
5. SPI-2 board (optional)
6. Ethernet connection (optional)
7. Analogue output (a)
8. Relays (b)
9. Power supply terminal block (c)
10. Type of power supply of the transmitter
11. Probe connection
12. Pressure connections (optional)
13. Cable glands

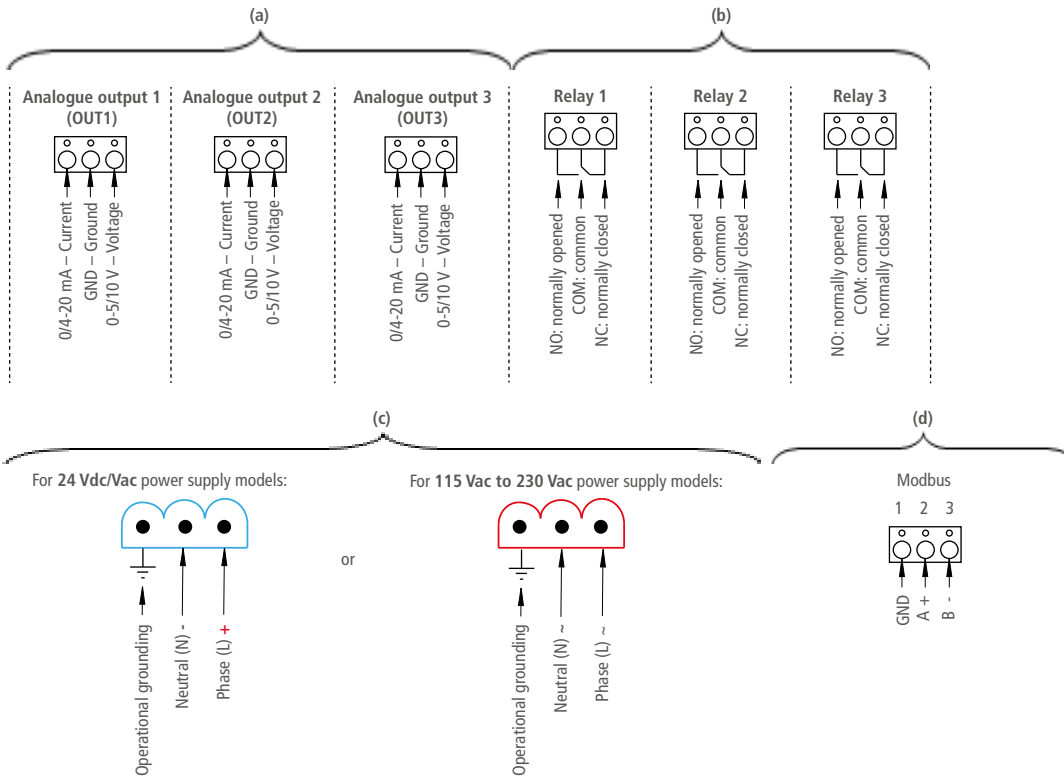

Electrical connections as per NFC15-100 standard



This connection must be made by a formed and qualified technician. Whilst making the connection, the transmitter must not be energized. The presence of a switch or a circuit breaker upstream the device is compulsory.

- For 24 Vdc power supply model:

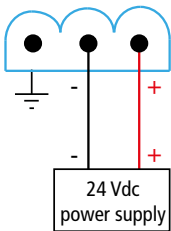

- For 115 Vac to 230 Vac power supply models:

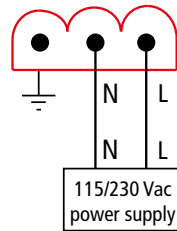

- For 24 Vac power supply model:

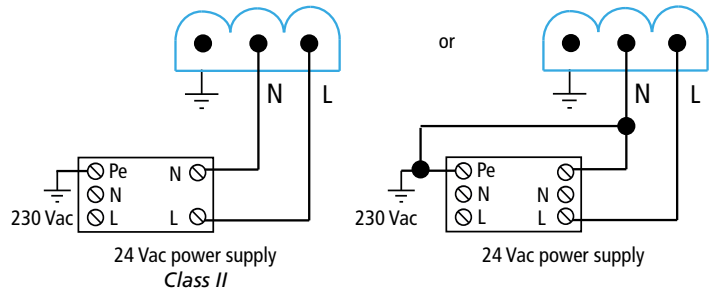

- 0/4-20 mA current output connection:

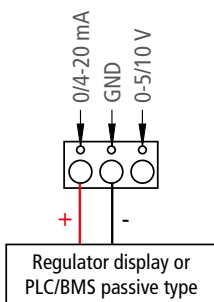

- 0-5/10 V voltage output connection:

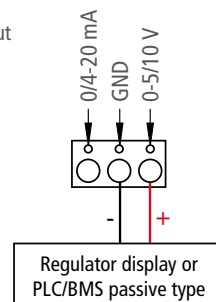

Configuration

Class 310 transmitters allows you to set all the parameters managed by the transmitter: units, measuring ranges, alarms, outputs, channels... via the different methods shown below:

- **Via keypad, only on models with display.** A code-locking system for keypad guarantees the security of the installation. See configuration manual.
- **Via software (optional):** simple and user-friendly. See LCC-S user manual.
- **Via Modbus (optional):** configuration of all parameters from your PC, via the supervision or data acquisition software.
- **Via Ethernet (optional):** configuration of all parameters from your PC, via the supervision or data acquisition software.

Mounting

Install the mounting bracket in horizontal position along a plane wall (see below dimensions / drilling drawing). Put the display inside the mounting bracket, with the 2 screws. Remove the screw covers located on the right and left side of housing, in order to have access to the 4 shutting screws. Make the electrical connection with the connection glands, with soft cable Ø7 mm maximum. Close the housing before powering on.

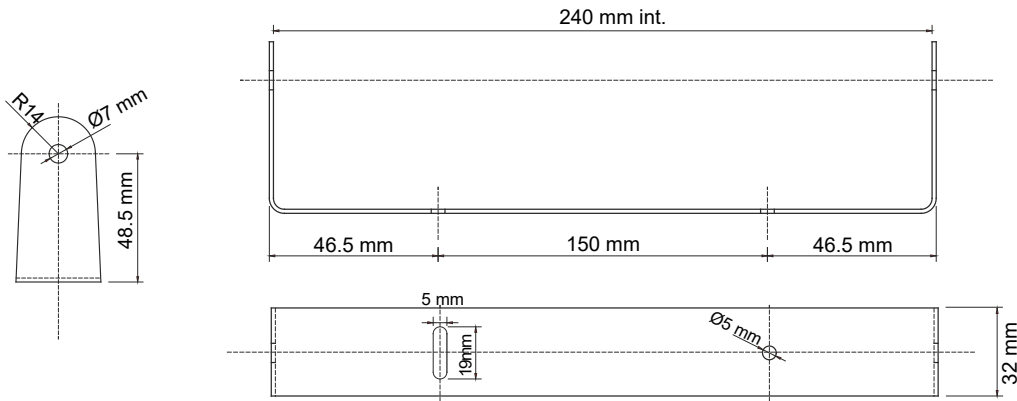

Maintenance

Avoid aggressive solvents. When cleaning rooms or ducts with products containing formol, protect the the transmitter.

Calibration

Outputs diagnostics: with this function, you can check with a multimeter (or on a regulator/display, or on a PLC/BMS) if the transmitter outputs work properly. The transmitter generates a voltage of 0 V, 5 V and 10 V or a current of 0 mA, 4 mA, 12 mA and 20 mA

Certificate: transmitters are supplied with an individual adjusting certificate and can be supplied with a calibration certificate as an option.

Precautions for use

Please always use the device in accordance with its intended use and within parameters described in the technical features in order not to compromise the protection ensured by the device.

Options and accessories

Name	Reference
Configuration software with USB cable	LCC-S
SQR/3 function: square root extraction function for the calculation of air velocity and airflow	-
Calibration certificate	-
RS 485 Protocol Modbus digital output	RS5
Ethernet board	CETHE-2
High resolution (example in pressure: 0.1 Pa) with SPI2-100 board	HRP



Only the accessories supplied with the device must be used.